

YORKVILLE & CONTOUR

Price and Specification Guide

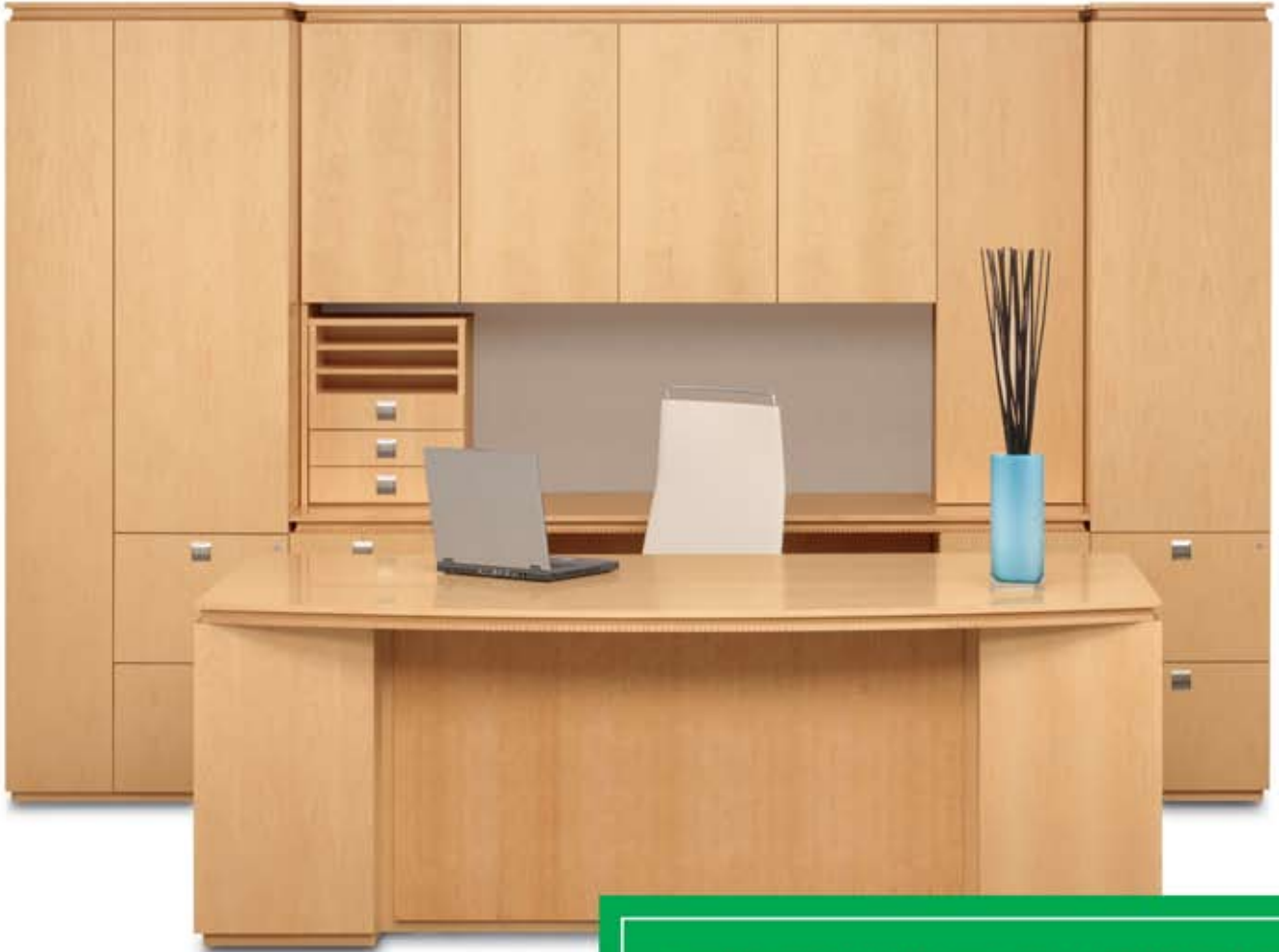

EFFECTIVE MARCH 1ST, 2008 A PRICE INCREASE
OF 5% WILL APPLY TO ALL PRODUCTS IN THIS
KRUG PRICE LIST.

krug

TABLE OF CONTENTS

2	General Information
YORKVILLE	
12	Product Specification Guide
25	Yorkville Product
CONTOUR	
72	Product Specification Guide
85	Contour Product

EFFECTIVE MARCH 1, 2008 A PRICE INCREASE OF 5% WILL APPLY TO ALL PRODUCTS IN THIS PRICE LIST

GENERAL INFORMATION

Terms and Conditions

Net 30 days. A late payment charge of 1% per month will be applied on overdue invoices. This charge will be pro-rated to the number of days past 30 days that the invoice is overdue. All applicable sales taxes are extra. Prices include shipping to territorial warehouse. Distribution of this price list does not in itself constitute an offer to sell. Orders can be received only from authorized Krug dealers. Acceptance of any order and terms of sale may be established at the discretion of Krug. Deposits are required on orders received from new accounts as well as on large or special orders.

Krug reserves the right to discontinue designs, or to change designs, construction, prices, or materials without notice.

Customer Service Hours

Please note customer service hours are:
8:30 am to 5:00 pm est
1.888.578.KRUG
1.519.748.5177 fax

Order Acknowledgements

Each order will be acknowledged via email or fax. This acknowledgement is the final agreement between Krug and the customer, superseding all previous communications regarding the purchase order. Where there is a discrepancy on a purchase order between a product code and a description, Krug will make every effort to resolve the discrepancy, but will be ruled by the product code ordered. Please check all acknowledgements for accuracy, and advise Krug of any discrepancies with a purchase order.

Cancellation

A cancellation can be made only by expressed agreement with Krug. A cancellation fee may be incurred for restocking.

Dimensions

Dimensions are in inches and approximate, and subject to change without notice. Contact Customer Service if dimensions are critical.

Storage Charges

Krug reserves the right to assess a nominal storage charge if a customer does not accept shipment of an order within a week of the ship date.

Contact Information

Phone: 1.888.578.KRUG
Fax: 1.519.748.5177
Purchase Order Fax: 1-888-236-4783
Web: www.krug.ca
Email: solutions@krug.ca

Installation Support

For assistance please contact Customer Service at 1-888-578-5784 and you will be directed to the appropriate installation support person.

Pricing

Krug endeavors to ensure that all prices in this price list reflect accurately our current prices. However, errors do occur and will be rectified through notices to the field. Krug reserves the right to acknowledge pricing that may be different from the price list.

Warranty

Krug warrants the construction and the finish of all our products to be free from defects in materials and workmanship for a period of 10 years from the date of purchase. This warranty does not apply to components not manufactured by Krug including textiles, which are subject to the specific warranties of those manufacturers, if any. Textile (fabric, leather, vinyl, or any other covering material) suppliers do not guarantee their products for durability and color fastness, and nor does Krug. Casters, mechanical and electrical components have a warranty of five years from the date of purchase. The Krug warranty does not apply to COM-specified materials, damage caused by a carrier other than Krug, or variation in wood finishes due to natural wood color variation. Krug cannot be held responsible for variations in fabric dye lots from order to order. All fabric is carefully inspected when it is received, but a degree of variation in color should be expected. Repair or replacement of any defect covered by the Krug warranty will be made at no charge to the original purchaser during the warranty period.

This warranty policy does not apply to defects resulting from negligence, misuse, alteration, improper cleaning, stains or accidents. Krug's judgement will be final in all matters concerning the condition of the furniture, the cause or nature of the defect, and the necessity or manner of repair.

Although Krug insures the highest quality workmanship in all of its products, Krug does not warranty against normal wear, fading, or damage that has occurred during the life of Krug leather upholstery. All leather pulls with use, especially in soft seating applications. Puddling and stretching is generated by repeated use and is a hallmark of genuine leather and not considered a defect.

Krug is not responsible for the damage or degradation of product that may occur due to extreme hot or cold temperatures after it has left Krug.

Krug product should not be exposed to any extreme hot or cold temperatures during its life. All products should be stored in climate-controlled warehousing and should be transported on climate-controlled trailers and containers, in order to protect its integrity. Trailers and containers should not be used for storage of products. Products should remain in a climate-controlled environment until the time that transport commences, and should be moved into a climate-controlled environment as soon as transport is completed. Exposure to extreme heat or cold temperatures voids the Krug warranty.

This warranty applies to products sold in North America only, and is made by Krug only to the original purchasers acquiring our products through authorized Krug dealers, directly from Krug, or from others specifically authorized to sell our products. Exceptions to Krug's 10 year warranty program include Thelma and Louise stacking chairs which have a limited warranty of one year, as well as Capri stacking chairs which have a limited warranty of two years from the date of purchase. Seating products intended for 24 hour usage receive a warranty of 3 years from date of purchase.

Export Packaging

Krug is pleased to provide the option for export packaging on all our products, to provide additional protection from damage.

Export packaging is provided at an upcharge of 5% of the net selling price per item.

Export Packaging is **STRONGLY RECOMMENDED** for:

(A) all shipments outside of the lower 48 states and Canada

(B) all shipments that will be held in storage for an extended period prior to installation

Important: Please note that Krug will not be responsible for damage claims on product shipped or stored in the above conditions but where export packaging has not been utilized.

Please contact Customer Service for specifications or any other assistance regarding export packaging.

Freight Terms and Conditions

1. All product is shipped FOB the Krug factory, with freight pre-paid to the destination (dealer's dock or territorial warehouse). Customers must select a standard delivery location for their orders.
2. Docks at the selected delivery location must be equipped to handle a 53' trailer.
3. When a Krug territorial warehouse is selected as the default delivery location, it is understood that Krug pays freight cost to the

territorial warehouse only, and no further. The Customer is responsible for all charges from this point.

4. Krug utilizes truck carriers that are dedicated office furniture specialists.

5. For all deliveries, it is understood that Krug or its agent is making a dock delivery only (equipped to handle a 53' trailer), and any further work of truck unloading, delivery beyond the dock, installation, and removal of packaging is not authorized or paid for by Krug.

6. Drop shipments to the installation site, and timed deliveries, are available on larger shipments (full truckloads or slightly less) at no additional charge. Drop shipments or timed deliveries for smaller shipments may not be available, or if available will require a surcharge. Deliveries on an after hours basis, or on weekends, or any other special requirements, may be subject to a surcharge. Location and contact information, and the requested time of delivery, is required at least one week prior to the acknowledged shipment date. If this information is not provided one week in advance, or if the location or time of the drop shipment is changed less than one week in advance, a surcharge may be applied, and/or the drop shipment may not be scheduled.

7. For all deliveries - whether to the Customer location or drop shipment - any circumstances that result in the delay of our carrier (including unsuitable receiving facilities, or facilities not open or available), service charges will be applied at the rate of \$75/hour. Where re-delivery is necessary because of these circumstances, the full cost of re-delivery will be charged.

Customer Satisfaction

It is the primary goal of Krug and our staff to insure the complete satisfaction of our customers with our products and performance.

If a problem arises with a Krug product after the expiration of the limited warranty period, Krug will exercise its best efforts to achieve the satisfaction of the customer in a manner that is fair to all concerned.

Damaged Shipments

All Krug product is carefully inspected, protected with well-engineered packaging, and expertly loaded onto our trucks at our distribution center. All shipments leave the factory in good condition. Do not refuse merchandise damaged in transit, as Krug is not responsible for damage to goods which occur in transit or storage. It is the purchaser's responsibility to examine the goods upon receipt and to file any claims with the carrier. Any damage or shortage

should be noted on the bill of lading. The delivering carrier may not accept responsibility for shortages or damages if signed for "clear". Notification of concealed damage claims must be made to the delivering carrier within 5 days after delivery. All cartons must be available for inspection. Carrier liability ceases after 5 days and neither Krug, nor the carrier, will be responsible for concealed damages if shipments are left unopened.

Krug is not responsible for the condition of product that is stored or installed in an environment where temperature and humidity are not controlled.

Field Product Report Authorization

Krug's written authorization, in the form of an FPR number, must be obtained prior to incurring charges of any kind if Krug is expected to pay these charges. This includes authorization for field repairs and replacements, installation and delivery charges. Krug reserves the right to have its representative inspect product related to any request for such authorizations, prior to that authorization being provided.

Deductions from invoices paid for any charges to Krug, without prior written authorization in the form of an FPR, will not be accepted. Digital photographs may be required to complete the FPR process.

Returns

No merchandise may be returned without Krug's prior written consent. In the event of an authorized return, a Field Product Report (FPR) number will be issued, and a restocking charge will apply. Return transportation charges must be prepaid. Unauthorized returns will not be accepted and will be returned freight collect. All merchandise being returned must be properly packaged in its original or comparable replacement packaging to insure protection of the product during handling and transportation. Returns on orders duplicated by the customer must be received in their original packaging to be accepted.

Product being returned where Krug has authorized its liability for replacement or repair will be thoroughly inspected on its return, and the results compared to the reason for the return stated on the FPR. Any discrepancies, such as additional damage, signs of usage, missing parts, etc., will result in an adjustment to the amount of credit issued.

Care and Maintenance

Wood Finishes

Although Krug's extensive finishing process insures a durable finish on all our products, there are several steps that can be taken to protect and prolong the life and beauty of the finish. Protect the top by placing felt pads on the bottom of any accessories and mechanical equipment. Rubber and oil will permanently mark surfaces. Use a desk pad to prevent possible damage and imprinting caused by writing instruments and sharp objects. Dust only with a clean, dry cloth, going with the grain. Clean any marks with a damp cloth, using a small quantity of mild soap or detergent.

Do not use any wax-based polish, spray or silicone. Eventually, a film will build up and discolor the top. Do not place your furniture in a position of permanent exposure to direct sunlight.

Frosted Glass

Krug frosted glass doors are susceptible to finger print grease residue when the frosted side of the glass is touched. If possible wear latex gloves when installing or moving frosted glass. To clean simply wipe with an ammonia based cleaner using a microfiber cloth. The key in cleaning frosted glass is to clean the whole inside surface so that it will appear uniform with no streaking. Frosted glass is cleaned basically the same way as regular glass but the inside frosted surface may need to be wiped a couple of times in order to get all of the dirt/grease out of the fine pores.

Plastic Laminates

Clean plastic laminates with mild soap and warm water. Do not use steel wool, hot water, or any abrasive cleaning product.

Fabric Upholstery

Professional upholstery cleaning is recommended.

Custom Capabilities

Over 15% of our orders involve some type of custom work, and we invite our customers to make use of our extensive capabilities.

These include:

- 1) Dimensional customization of standard size products
- 2) Custom finishes
- 3) For larger orders, completely custom-designed products, as well as non-standard wood species can be specified.

Custom orders may require additional production lead times. Contact Customer Service for more information.

WOOD FINISHES

Wood Finishes

Standard wood finishes are:

Species	Finish
Cherry	Appalachian Cherry
	Imperial Cherry
	Medium Cherry
	Natural Cherry
	Standard Cherry
	American Cherry
Maple	Clear Maple
	Honey Maple
	Wheat Maple
Oak	Light Oak
	Harvest Oak
	Mahogany on Oak
	Medium Cherry on Oak
	Mellow Oak
	Walnut on Oak
	Espresso on Oak

Wood is a natural product with inherent color variations that will never be fully mitigated by the finishing process. Please anticipate variation in colors within a single unit, from piece to piece, and from Krug wood finish samples. If a very close match is required, a sample must be provided with the order and an upcharge will apply. Exact color matches are not possible.

Custom Wood Finishes

Add 10% list to your order for special finishes, minimum upcharge is \$500 list per finish per order. (For example, on all orders up to \$5000 list, an upcharge of \$500 will apply, on orders \$5000 and up add 10% list to your order.)

For orders with special finishes, a sample that is a minimum 3” by 3” must be received with the order. Special finishes may add additional lead time to production schedules.

Since wood is a natural product, some variations in grain, color and stain acceptance will occur. In our finishing processes, we try to minimize variations, but some variation between samples and finished goods should be anticipated.

Birdseye Maple

Bookmatched Birdseye Maple veneer is available at an upcharge of \$50 list per square foot. Specify clearly on order. Birdseye Maple is recommended in a clear finish only. Birdseye Maple only applies to tops.

Dual Finishes

Add 10% list per item if specifying dual finish.

IN-STOCK LAMINATES

In-Stock Laminate

Krug's in-stock Laminates are available in 16 different laminate selections. There are 8 wood grain laminates, 4 solid color laminates in a selection of popular solid shades and 4 Exotic laminates offering a distinguished appearance. Polymer Edge will be selected to match the worksurface.

In-Stock Laminates

Wood Grain Laminate

Name & Number	Supplier	Polymer Edge Names
Corretto Cherry HP-288-N	Pionite	Corretto Cherry
Flamenco Cherry T462	Arborite	Flamenco Cherry
Mocha Cherry HP-341-N	Pionite	Mocha Cherry
Monticello Maple 7925	Wilsonart	Monticello Cherry
Nightfall WX421-N	Pionite	Nightfall
Samba Cherry T460	Arborite	Samba Cherry
Shiraz Cherry T472	Arborite	Shiraz Cherry
Sugarloaf Maple T630	Arborite	Sugarloaf Maple

Solid Laminate

Name & Number	Supplier	Polymer Edge Names
Almond T445	Pionite	Almond
Black T203	Arborite	Black
Shadows T201	Arborite	Shadow
White D354-60	Wilsonart	White

Exotic Laminate

Name & Number	Supplier	Polymer Edge Names
Backwoods Sycamore HP689-N	Pionite	Backwoods Sycamore
Edgewood Sycamore HP690-N	Pionite	Edgewood Sycamore
Gunstock Walnut WW971-N	Pionite	Gunstock Walnut
Thunderstorm HP359-N	Pionite	Thunderstorm

Non-Stocked Laminates

For specific lead time and application questions, please contact Krug Customer Service for your requirement. Upcharges will be applicable for non-stocked laminates, depending on their cost. Non-stock laminates may require a minimum order quantity, please contact customer service. Stocked polymer edges can be specified for use with non-stocked laminates.

The following plastic laminates are acceptable for application on Krug products as they feature a matte finish:

Nevamar	All plastic laminates with "T" in the suffix (i.e., MR2002T)
Wilsonart	All plastic laminates with "60" in the suffix (i.e., 4779-60)
Arborite	All plastic laminates with "CA" in the suffix (i.e., 1531-CA)
Pionite	All plastic laminates with "Suede" in the name (i.e., WW561 Suede)
Formica	All plastic laminates with "58" in the suffix (i.e., 756-58)

Arborite Laminates 1.800.996.0366	Wilsonart Laminates 1.800.433.3222
Pionite Laminates 1.800.746.6483	Formica Laminates 1.800.367.6422
Nevamar Laminates 1.800.638.4380	

Additional plastic laminate codes may be acceptable for use on Krug furniture, however, they could be subject to an additional upcharge or extended lead time due to material complexity. High sheen plastic laminates are not acceptable for application on Krug furniture due to their inherent nature of scratching and maring during the production process.

FABRICS | LEATHER

EFFECTIVE MARCH 1, 2008 A PRICE INCREASE OF 5% WILL APPLY TO ALL PRODUCTS IN THIS PRICE LIST

Krug Momentum Panel Fabric Program

Krug introduces the Momentum panel fabric program available for application to tackboards.

The panel fabrics are 66" wide and constructed of 100% polyester.

The following selections are standard at Krug and are priced as grade one fabrics on tackboards. These fabrics are designed for tackboard application and are recommended for use.

Universe	Meander
Crème Brûlée	Agate Taupe
Depth	Overcast
Wheat	Nightshadow
Cosmic	
Milky Way	
Seneca	

The Momentum panel fabrics pass ASTM-E84-87 Fire Codes.

Please refer to the Momentum fabric card for color reference.

If memo samples are required please call Momentum at 1-800-366-6839.

Standard Fabric Program

Krug Grade 1, 2 and 3 fabrics are also available on a cut yardage basis. Pricing is shown below. All prices are net, FOB Kitchener.

Grade 1 - \$29/yard net

Passport 20217	Motion 50020	Sequence 50516	Solo 50529
Safari 101	Clay 105	Sand 802	Jute 101
Maize 201	Straw 104	Nutmeg 203	Taupe 107
Mystic 801	Stone 801	Onyx 901	Slate 801
Willow 504	Cactus 507	Moss 502	Fennel 503
Ruby 302	Garnet 308	Cardinal 301	Paprika 308
Eclipse 402	Midnight 401	Lapis 401	Gulf 401
Asphalt 901	Gunmetal 806	Chestnut 701	Ink 903

Grade 2 - \$39/yard net

Manhattan 09513	Linia 50169	Freestyle 50615	Matrix 04126
Wisp 8012	Tan 106	Fawn 101	Steel 021
Spice 8000	Wheat 207	Honey 201	Bronze 040
Sable 8007	Smoke 806	Pewter 801	Graphite 011
Olive 8005	Wintermoss 504	Sage 501	Custard 022
Pimento 8002	Beaujolais 308	Crimson 301	Pumpkin 050
Pacific 8006	Ocean 407	Twilight 401	Cobalt 012
Obsidian 8010	Carbon 905	Raven 901	Jet 015

Grade 3 - \$49/yard net

Ellipse 08707	Luxura 20339	Transit 50302	Mirage 02386
Flax 102	Malt 102	Birch 103	Mist 2196
Ginger 203	Camel 201	Buff 102	Storm 2197
Chocolate 702	Espresso 703	Cocoa 702	Coffee 2198
Lime 501	Pistachio 502	Mint 512	Forest 2191
Chili 304	Claret 301	Blaze 305	Flare 2188
Navy 403	Atlantic 403	Azure 405	Thistle 2194
Platinum 801	Cinder 901	Shadow 804	Ebony 2199

Standard Leather Program

Grade 8			
Espresso	K13.8000	Port	K13.2000
Sand	K13.5000	Cobalt	K13.7000
Stone	K13.3000	Cypress	K13.6000
Graphite	K13.4000	Onyx	K13.1000

Customer's Own Material (COM)

COM must be received three weeks prior to the acknowledged ship date. Orders with COM not received by the required deadline will be delayed.

A description of the fabric, including supplier name, fabric name and color number must be included with the purchase order.

When the COM fabric is received at Krug, it must be clearly identified with the fabric name and color, and tagged with name of the Krug customer and purchase order number. Krug will inspect all COM fabric when received to determine if it will be suitable for upholstery. Where Krug feels that the fabric or leather specified will compromise the quality or integrity of our products, customers will be contacted to direct these concerns. Further, Krug reserves the right to refuse to accept and use any COM fabrics or leathers that will compromise our products in any way that is unacceptable to Krug. Krug cannot assume responsibility for the durability or tailoring quality of customer's own material.

Yardage specified in this price guide is approximate. In the case of multiple product orders, multiply the number of items by the COM yardage specified to determine fabric required, unless otherwise indicated. Additional yardage may be needed if the material is less than 54" wide, or patterned or striped and requires matching. As fabric is applied horizontally, non-directional fabrics are recommended. COM fabrics are applied as they come off the roll unless otherwise specified. All striped fabrics will be applied vertically unless otherwise stated by the customer and after approval by Krug. It is the customer's responsibility to advise Krug if the upholstery is to be applied otherwise, and to advise Krug of any special upholstery instructions. Special instructions should be sent to Krug Customer Service, including a sample (or photocopy) of the fabric. Krug is not responsible for instructions sent with the fabric rolls, or for the method of upholstery if no instructions have been provided.

COM Shipping Procedures

For tackboard COM fabrics, please send fabrics to:
 Krug Inc.
 111 Ahrens Street
 Kitchener, Ontario
 Canada N2H 4C2
Attention: RECEIVER

All packages must be clearly marked "For Customs Clearance by Russell A. Farrow Custom Brokers". According to the North American Free Trade Agreement (NAFTA), goods shipped between the United States and Canada can qualify for exemption from all duties, or for a reduction in duties, if the goods can be proven to originate in either the United States, Canada or Mexico.

Canada Customs requires that a NAFTA Certificate of Origin and a Commercial Invoice be completed and sent with the fabric shipment. The Commercial Invoice must clearly state the description of the fabric, the selling price, the make-up or content, and the purchaser. The absence of these two documents will delay the shipments at the U.S./Canada border, thereby potentially delaying the customer order. If the total value of the shipment is less than \$1200 U.S., Customs will accept a Low Value Statement of Origin in place of the NAFTA Certificate of Origin. The Low Value Statement must be signed by a representative of the exporting company. This statement may either be included on the commercial invoice or attached to the invoice.

Krug is happy to answer any questions or concerns about COM shipping procedures and the required documents. Please contact our Customs Specialist at 1.888.578.5784.

KRUG EXPRESS



PROGRAM DETAILS

KrugExpress orders are ready to ship by the date acknowledged. Delivery and shipping schedules may result in actual shipping of orders at a later date. Statutory holidays and scheduled factory vacations may add to acknowledged lead times of *KrugExpress* orders. Unless otherwise specified on the order, the customer's standard method of shipping Krug products will be utilized.

Available factory capacity for *KrugExpress* is filled by orders received on a "first come, first serve" basis. If the normal *KrugExpress* lead time is not available for your order because available capacity has been filled, you will be immediately advised of the earliest available ready-to-ship date. Please consult your Customer Service representative in advance if you wish to confirm the specific lead time availability for a *KrugExpress* order.

Orders must be received by midnight of a given day for that day to be considered the official day the order is received. Order lead times are acknowledged from the date the order is received, but not including the date the order is received.

KrugExpress orders must be "clean" when received in order to be considered officially received on a given day, and lead times will be acknowledged from the date orders are determined to be "clean".

Changes to *KrugExpress* orders are not allowed under any circumstances.

Orders for product on *KrugExpress* must clearly state: "*KrugExpress*".

*Some conditions apply. Please see below for details.

YORKVILLE

Available in all standard Cherry and Maple finishes.

Only Krug in-stock panel fabrics are available on *KrugExpress*.

Items not available: AV Cabinets, Non-Krug panel fabrics

Please see page 4 for a list of Krug standard wood finishes available on this program.

CASEGOODS PROGRAM

Orders for casegood products on the *KrugExpress* program may be subject to quantity maximums. Please contact Krug Customer Service for more information.

Quantity maximums are dependent upon available capacity, in order to insure that we ship all orders on time.

Only actual casegood pieces and conference tables tops and bases are considered "units". Items such as tasklights, tackboards, keyboard trays and drawers, electrical and wire management components, etc., are not considered under the quantity restrictions.

For example, a typical office configuration that includes a desk, linking unit, credenza and hutch/overhead, equals a total of four units for the purposes of the quantity maximum.

Only Krug In-stock panel fabric is available on the *KrugExpress* program. Only standard wood finishes are available for *KrugExpress* orders. Grommets can be specified in standard positions only. Laminates are not available on *KrugExpress*.

KrugExpress also includes all Krug seating and occasional tables as well as Krug conference products to complement this casegoods offering.

The *KrugExpress* logo at the top of a price guide page indicates that the items on the page are available on *KrugExpress*, unless noted otherwise.

CONTOUR

Available in all standard Oak, Cherry and Maple finishes.

Only Krug in-stock panel fabrics are available on *KrugExpress*.

Items not available: AV Cabinets, Non-Krug panel fabrics, Laminate Tops

GUIDELINES AND PRICING METHODS

EFFECTIVE MARCH 1, 2008 A PRICE INCREASE OF 5% WILL APPLY TO ALL PRODUCTS IN THIS PRICE LIST

PRICING METHOD

Custom widths: Apply the price of the same unit in the price list that is one standard size larger than the desired case size (but same depth).
For example: The required custom dimension is 74" x 24". The first standard size above this is 78" x 24", so in this case, you would apply the price of the 78" x 24" unit.

Custom depths: Apply the price of the same unit one size deeper (but same width).
For example: The required custom dimension is 72" x 26". The first standard size above this is 72" x 30", so in this case, you would apply the price of the 72" x 30" unit.

Custom width & depth: Apply the price of the same unit both one size wider and one size deeper.
For example: The required custom dimension is 74" x 26". The first standard size above this is 84" x 30", so in this case you would apply the price of the 84" x 30" unit.

Custom height of desk height cases: Add 18%. (31-32" HI)

OTHER PRICING METHODS

9300 & 9700 - cases where tops are flush left/right or both, add:	\$75 list
(All) Grommets in non-standard positions, add:	\$250 list
(All) To remove hutch or overhead doors, deduct:	4% list
9700 - convert 5-hi hutch to 6-hi hutch, add:	20% list
(All) Bookcase with optional pull out printer shelf at standard shelf height, add:	\$150 list
(All) Bookcase with optional vent in back (includes 2 vents and 1 grommet), add:	\$200 list
9300 & 9700 - convert 5-hi storage to 6-hi storage, add:	6% list
(All) 2 lateral file and 3 or 4 closed shelves - convert to half open, half closed shelves, add:	15% list
(All) 2 lateral file and 3 or 4 closed shelves - convert to half open, half wardrobe, add:	15% list
(All) To remove storage doors for open shelves, deduct:	4% list

EXCEPTIONS TO THE PRICING METHODS ABOVE

Sizes larger than largest shown in Price List.
Non-standard extension on drawer slides.
Non-standard drawer depths in standard depth pedestals.
Glass door – any style.
Cases with curvilinear tops where the radius becomes non-standard.
A/V cabinets.

Please contact Specials Coordinator or Krug Customer Service at 1.888.578.KRUG if you require assistance.



PLEASE NOTE: Cases with non-standard features do not apply to the rules above.
Contact Krug Customer Service if you require assistance.

EFFECTIVE MARCH 1, 2008 A PRICE INCREASE OF 5% WILL APPLY TO ALL PRODUCTS IN THIS PRICE LIST

YORKVILLE

Product Specification Guide

12	General Product Specifications
13	Edge Detail Profiles
14	Grain Direction, Pulls & Locks
15	Grommets
17	Desks & Credenzas
18	Linking Units, Corner Units, Hutches, Overheads & Tackboards
19	Tasklights & Installation
20	Filing Instructions
21	Installation
23	Suggested Configurations

Product List

25	Desks
29	Curvilinear Desks
33	Returns
38	Curvilinear Returns
40	Linking Units
41	Corner Units
42	Credenzas
49	Overheads
50	Hutches
55	Paper Managers
56	Pedestals
57	Meeting Tables
58	Keyboard, Pencil Drawers & Grommets
60	Accessories
61	Bookcases, Storage & Wardrobes
70	AV Cabinets

EFFECTIVE MARCH 1, 2008 A PRICE INCREASE OF 5% WILL APPLY TO ALL PRODUCTS IN THIS PRICE LIST

GENERAL PRODUCT SPECIFICATIONS

EFFECTIVE MARCH 1, 2008 A PRICE INCREASE OF 5% WILL APPLY TO ALL PRODUCTS IN THIS PRICE LIST

Worksurfaces

Tops are 5/8" thick veneered particle board core edges with 1/8" wood edging on four sides. The upper panel is secured to a 1 1/4" thick lower panel, which provides an overall top thickness of 1 7/8".

Modesty Panels

Modesty panels are standard on all desks, returns, link units, credenzas and are optional on shaped tops with half drum bases. Modesty panels are not available in conjunction with shaped tops that have metal post legs. Modesty panels on credenzas are 3/4" thick. Modesty panels on link units, returns and desk modesty panels are 1 1/2" thick.

Veneer

External face veneers are Cherry or Maple book-matched veneer.

Bases

Bases are 1 1/4" thick edge banded particle core.

Finish

A five step catalyzed varnish finish that when dry has a sheen value of 32°, is applied to all finished cases.

Locks

Locks are standard on all pedestals and storage unit lateral file drawers with the exception of bookcase pedestals. Locks are optional on wood door fronts and must be specified at time of order.

Drawers

Drawer slides have ball bearing movement with positive outstep and hold in catch. File drawers and box drawers have a load bearing capacity of 100 lbs. Drawer interiors have Birch veneer sides with matching bottoms. File drawers are designed for letter and legal filing. All box/box/file pedestals in desks, corner credenzas and modular pedestals are supplied with matching pencil tray.

Glides

Adjustable glides are 1" long and allow for a range of adjustment of 3/4". Glide inserts are installed at factory, glides need to be field installed.

Hinges

Hinges on all hutch and overhead doors are European style with a 95° opening. All hinges are fully adjustable.

Code Description

Left and right designations within model numbers are allocated from the user's position.

Latches

Bookcase and storage unit doors are equipped with touch latches mounted inside the top edge of the door.

Testing Information

Yorkville meets or exceeds the testing requirements of ANSI / BIFMA X5.5-1998.



EDGE DETAIL PROFILES

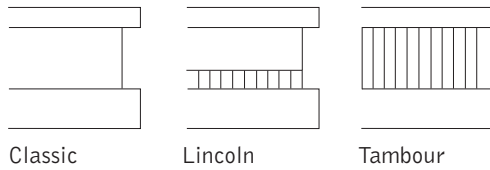

Profiles do not appear on all edges of all products, please refer to this summary for locations.

KEY:

- Profile Edge
- Flush Edge



Desks

Desks have profiles on all sides.
Plan view of a desk shown left.



Credenzas

Credenzas have profile on all sides.
Plan view of a credenza shown left.



Curvilinear Desks

Curvilinear desks have profile around the curved and end section.
Plan view of bullet top and P top shown left.



Returns and Link Units

Link units have profile on front and back edge.
Plan view of a link unit shown left.



Returns feature profile on three sides.
Plan view of a return shown left.



Corner Credenzas

Plan view of a corner credenza shown left.



Corner Units

Plan view of a corner unit shown left.
Linking edges are not profiled.

EFFECTIVE MARCH 1, 2008 A PRICE INCREASE OF 5% WILL APPLY TO ALL PRODUCTS IN THIS PRICE LIST

GRAIN DIRECTION | PULLS | LOCKS

Grain Direction

Yorkville products are designed such that the grain direction is as shown in the diagram to the left.

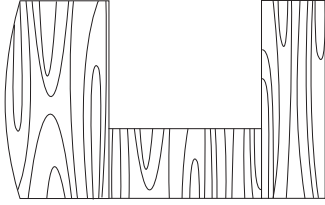

Pulls (Available on drawers only)

Two distinctive pulls are offered on Yorkville.

The Knox pull has a centered mounting location and is 7/8" in diameter.

The Knox pull is satin nickel.

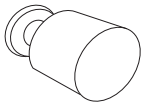

The Seton pull has a centered mounting location recessed in the case.

The Seton pull is satin nickel.

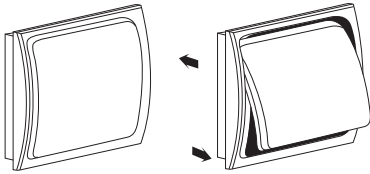

Locks

Locks are provided as a standard feature on all pedestals, except bookcase pedestals, including those in desks, credenzas and lateral file storage units. Lock plugs on desks, credenzas & returns are located in the kneespace on the pedestal side panel. Lateral file drawers have locks on the top right corner of the top drawer face.

Locks are not available on glass doors.

Locks are available on bookcase doors at an upcharge of \$100 list per set of (2) doors, please specify at the time of order.

Lock plugs are generally located on the lower inside corner of the door front for storage units.

Lock plugs for hutch and overhead doors are generally located on the lower inside corners.

Suites can be keyed alike at no upcharge, please specify on your Purchase Order.

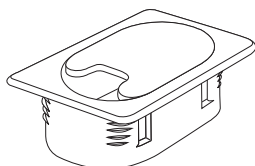

Grommets

All cases may be specified with one grommet in a standard position at no upcharge. A \$100 list upcharge will apply to additional grommets in standard positions and for grommets requested in non-standard positions a \$250 list upcharge will apply.

The grommet position must be indicated for each case on the order.

Standard Grommet
Black, rectangular, 4 1/8" x 2 11/16".

Grommets can also be field installed with a power drill, a 2 1/4" hole saw and a rasp or saber saw. Template for drilling is available.

Please keep in mind the location of grommets when specifying paper managers for use with worksurfaces. For example, a paper manager on the left hand side may be used with a "C", "BR" or "AR" grommet.

Grommets are not available over a pedestal on Yorkville product.

Standard Grommet Positions

Desks

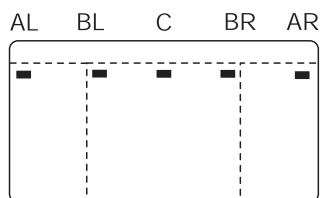

36" deep Desks:

- Position Code:
 AL – left corner
 BL – left end beside pedestal gable
 C – center
 BR – right end beside pedestal gable
 AR – right corner



Curvilinear Tops

- Position Code:
 C – center

This key applies to all bullet and P-shaped tops
 The support panel is notched out to accommodate wire management.



GROMMETS

EFFECTIVE MARCH 1, 2008 A PRICE INCREASE OF 5% WILL APPLY TO ALL PRODUCTS IN THIS PRICE LIST

Grommets

Power and Communication Grommets

As companions to the standard grommets, the Yorkville product line incorporates various power and communication options. These items provide easy worksurface access for power and phone or data connections. Wire management raceways are also available for below surface mounting. All components must be specified for quantity and location. Refer to pages 58 and 59 for pricing information.

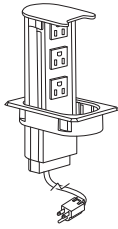

Pop-Up Power Center (93PUPC)

Power Center Details:	Dimensions:
three Simplex outlets	4 1/8" x 2 11/16"
10 ft. 15 Amp power cord	5 1/8" above worksurface
10 Amp circuit breaker	8 1/2" overall depth

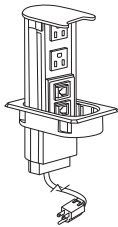

Pop-Up Power Center (93PUPD)

Power Center Details:	Communication Details:	Dimensions:
two Simplex outlets	one RJ11 phone coupler	4 1/8" x 2 11/16"
10 ft. 15 Amp power cord	one RJ45 data coupler	5 1/8" above worksurface
10 Amp circuit breaker		8 1/2" overall depth

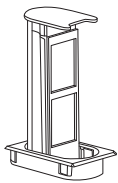

Pop-Up Communication Housing (93PUCH)

Supplied with adapters for RJ11 or RJ45 couplers.

Dimensions:
 4 1/8" x 2 11/16"
 7 1/2" above worksurface
 8 1/2" overall depth

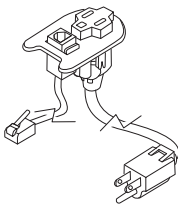

Power and Telephone Grommet (93PDSM)

Black, rectangular surface mount power and communication grommet.

Power details:	Communication Details:	Dimensions:
one Simplex outlet	one RJ11 phone line coupler	4 1/8" x 2 11/16"
15 Amp, 6 ft. cord	6 ft. cord	

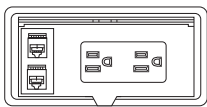

Power / Data / Voice Module (supplied with wired hutches)

Black, rectangular with flip down cover. Includes two power outlets, one voice port, and one data port.

Power Details:	Communication Details:
two Simplex outlets	one 6-pin and one 8-pin connector
15 Amp, 10 ft. cord	

DESKS

EFFECTIVE MARCH 1, 2008 A PRICE INCREASE OF 5% WILL APPLY TO ALL PRODUCTS IN THIS PRICE LIST

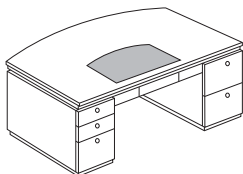

Modesty Panels

All modesty panels on Yorkville desks have a built up feature that is 1 1/4" inset from the side and bottom edges of the modesty panel. The built up feature sits flush with the top of the modesty panel and the bottom of the desk top.

Single pedestal desks feature a closed support pedestal.

Options

Leather Inserts are available on all desks at an upcharge of \$1000 list.

The center drawer option can be specified on double pedestal desks by adding "CD" to the end of the desk model number and applying a \$350 list upcharge.

Bow tops are available on all desks by adding "BT" to the end of the desk model number. Please reference page 28 for more information and the size appropriate upcharge.

Special Veneer Modesty Panels

Anigre, Figured Cherry or Birdseye Maple veneers can be specified on the built up feature on desk modesty panels. This option requires a \$200 list upcharge. Please state clearly on Purchase Order. Special veneer modesty panels are not available on *KrugExpress*.

CREDENZAS

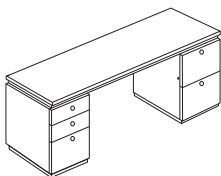

Yorkville offers a wide variety of credenzas for use as stand alone storage pieces, part of a connected worksurface configuration, or behind a desk. Choose from single or double pedestal options.

All cases are available with a wiring grommet in a standard position for added cable management, please specify on your order. Wiring grommets cannot be specified above the pedestal location.

Pedestals

Yorkville credenzas are also available with single file drawer or lateral file pedestals.

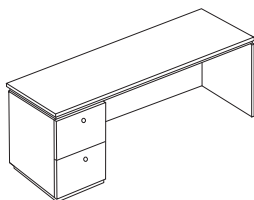

LINKING UNITS | CORNER UNITS

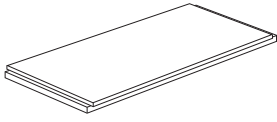

Yorkville linking units and corner units are available in a range of sizes for ease of use in configuring a connected worksurface.

Linking Units

Linking units are for use between desks and credenzas in creating a U-shaped configuration, and must be supported at both ends. They are available with or without modesty panels.

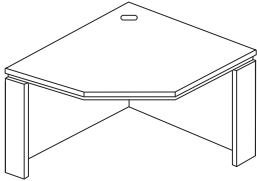

Corner Units

A corner unit can also be used on a U-shaped configuration, or it can be an integral part of an L-shaped work area with returns linked to either side.

Corner units have a standard grommet included in the back corner for ease of cable management, and have additional wire management access grommets in the half gables so that cable can be run to other areas of the connected worksurface. This can be assisted by a cut length of wire management cover.

HUTCHES | OVERHEADS | TACKBOARDS

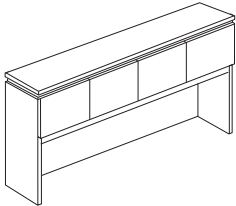

Yorkville offers hutch and overhead options for upper storage in a work area.

All hutches and overheads include tasklights that are factory installed and require no field adjustment. Tasklights are mounted beneath the cabinet and hidden from view.

Wood framed frosted glass doors are available on selected hutches and overheads.

Doors

Doors are equipped with fully adjustable European style hinges.

Locks are optional and can be specified at time of order for an upcharge of \$100 list per set of (2) doors. If an uneven amount of doors require locks, the lock on the single door is also \$100 list. Locks are not available on wood framed glass doors.

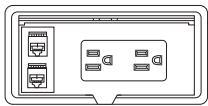

Hutch Power / Data / Voice Module

Access to power and data is made simple by using a hutch with a power/data/voice module built right into the tackboard. The module is fully installed at the factory but can be removed to connect data links on site. It features a flip door that retracts into the case of the unit when open.

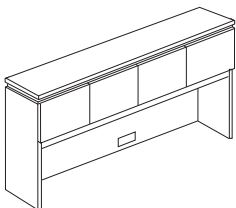

Tackboards

A tackboard in Krug Momentum panel grade 1 fabric is included with every hutch. Upcharges for higher graded fabrics are listed on page 54. Please note not all fabrics are suitable for tackboard application. Tackboard fabric selections should be supplied with the order information. Fabric options are listed on page 6 of this price guide.

Tackboards are not included with overheads and must be ordered separately, see page 49 for pricing. Overhead tackboards include wall mounting hardware and instructions. Tackboards for hutches are installed at the factory and require no additional set up on site.

Only Krug Momentum Panel fabrics are available on *KrugExpress*.

Hutch Tackboard Yardage

On single piece hutches, the yardage requirement for two tackboards is the same as for one tackboard. Please keep this in mind when ordering more than one tackboard. For example, if the number of tackboards required is 7 and the COM requirement for 1 tackboard is 1.5 yards, the calculation for COM yardage is as follows: 4.5 yards are required for 6 tackboards + 1.5 yards for the 7th tackboard for a total of 6 yards. In the case of an even number of tackboards, divide the number of tackboards required by 2 and multiply that number by COM requirement on the chart. The fabric must be at least 54" wide in order to qualify for this procedure. If the fabric is less than 54" wide, the COM yardage listed on the chart is the amount required for each tackboard.

COM Yardage Calculation Chart for Tackboards

Quantity of Tackboards Required (example: 60")	Number of Yards Required per Tackboard (example: 60")	Number of Yards Required in Total (example: 60")
one	2 yards	2
two	2 yards	2
three	2 yards	4
four	2 yards	4
five	2 yards	6
six	2 yards	6
seven	2 yards	8
eight	2 yards	8

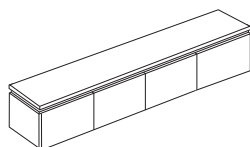

Tasklights

Tasklights are included with hutches and overheads and are installed before shipment. On hutches, the tasklight cord is threaded behind the hutch through a standard access grommet on the upper right hand side of the back panel. This access grommet is hidden from view behind the installed tackboard.

Tasklights are installed on the underside of overhead units. Cords run down the right hand side of the tasklight to the worksurface where they can be routed behind the worksurface top. The use of a wall mounted overhead tackboard conceals the cord from view.

Installation

Hutch and overhead installation instructions are included with every case or can be found in this guide on pages 21-22. All mounting hardware required is included with the product.

FILING INSTRUCTIONS

EFFECTIVE MARCH 1, 2008 A PRICE INCREASE OF 5% WILL APPLY TO ALL PRODUCTS IN THIS PRICE LIST

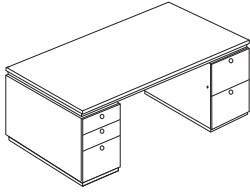

Drawers offer letter and legal size filing.
All units are equipped with file bars that are fixed in place for shipping.

Desk Pedestal File Drawers

Filing Capacity:

15" drawers
21" of letter filing front to back, or
12" of legal filing side to side
15" pedestal drawer depths allow only one row of side to side files.

Weight capacity of pedestal file drawers is 90 lbs.

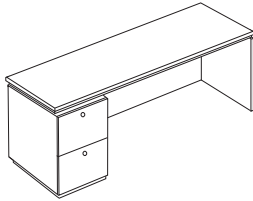

Credenza and Return Pedestal File Drawers

Filing Capacity:

15" drawers
15" of letter filing front to back, or
12" of legal filing side to side
15" pedestal drawer depths allow only one row of side to side files.

Weight capacity of pedestal file drawers is 90 lbs.

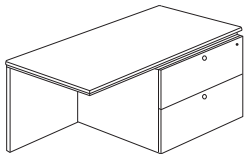
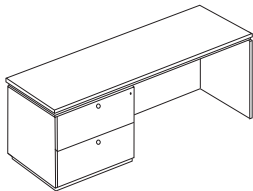

Credenza, Return or Storage Lateral File Drawers

Filing Capacity for 30" wide drawers:

30" inches of letter filing front to back, or
25" inches of legal filing side to side, or
15" of legal filing front to back.

When filing front to back, 30" lateral file drawer widths allow two rows of letter filing, but only one row of legal file width.

Filing Capacity for 36" wide drawers:

30" inches of letter filing front to back, or
36" inches of legal filing side to side, or
30" inches of legal filing front to back.

Weight capacity of lateral file drawers is 135 lbs.

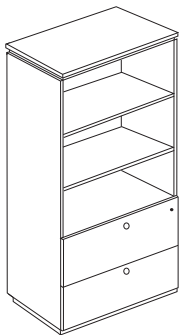

Linking Units, Tops and Returns

It is important that the main units (desk, credenza) to which the linking unit or return is being attached be in their final position and leveled.

Units are connected with mending plates under worksurface and wood screws on modesty and end panels. Locate connections and attach the mending plate under the worksurface. Level pieces if necessary by adjusting the glides to achieve flush and firm joints before completing installation of hardware.

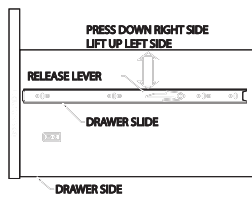

Drawer Removal

Pull drawer and slide out to the full extension position. With index finger, lift up the release lever on left side and press down the release lever on right side of the drawer (as shown). Make sure that you do this to each side at the same time.

Pull out the drawer with the attached drawer channel from the cabinet member.

To re-assemble, insert the drawer through the guide of the stop bumper.

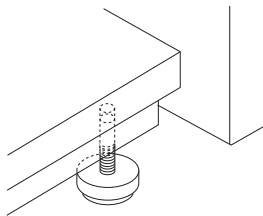

Glide Adjustment

Raise one corner of the unit at a time and adjust the glide to the desired height by turning the glide in the hole. Make sure unit is level after adjusting the glides.

Please note that the maximum adjustment range of the glides is 3/4".

When moving units after glides have been inserted, dial the glides to the lowest position to prevent damage.

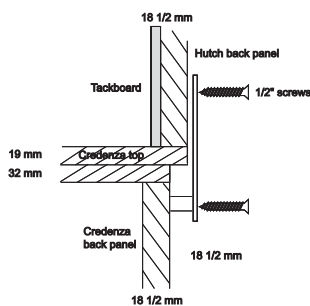

Hutch Installation

Before installing the hutch, insure that the worksurface has been placed in the final position and leveled. The worksurface should then be moved out a sufficient distance to allow access to the back. It is recommended that the minimum amount of movement be used with the leveling glides extended to prevent damage to the glides.

The hutch comes with self-adhesive foam strips that must be applied to the bottom edge prior to placing the hutch on the credenza. The foam is best applied with the hutch lying on its back. Do not leave any gaps in the foam strip, in order to prevent scratches to the credenza top while placing the hutch.

Place the hutch securely on the worksurface. Try to minimize any movement of the hutch to prevent scratching. Use of a blanket on the front portion of the credenza is recommended.

INSTALLATION

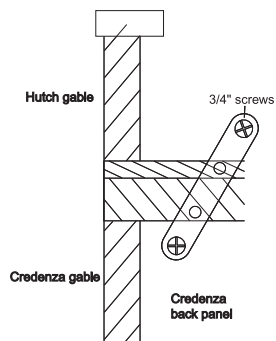

Hutch Installation (continued)

Using the supplied hardware, screw the flat bracket to the credenza back panel through the nylon spacer at each end, using the 1 1/4" screws provided. Swing the bracket up to approximately 60° and screw through the bracket into the Hutch back with the 3/4" screws. Tighten all screws. Move combined hutch and credenza back to final location. Check for level again and adjust as required.

Please note that hutches are shipped with tackboards and task lights already installed.

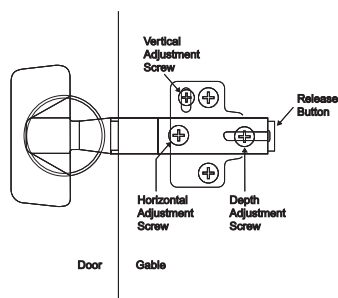

Door Adjustments

Hinges on all bookcase, overhead and hutch doors are designed to be adjusted for depth, horizontal and vertical alignment. This is easily done by adjusting the appropriate screw. See drawing.

To remove a door, push the release button and pull out the door, disconnecting the hinges.

The doors on hutches, overheads and storage units all use magnetic touch latches.

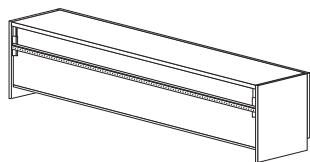

Overhead Units

The wall mount overhead storage units must be installed on wall studs. The first step for installation is to locate the studs in the wall where the overhead is to be mounted.

Position the overhead hanger rail on the wall to insure studs line up with pre-drilled holes in the hanger rail and mark the location on the wall. When mounting always use hanging rail across back.

Drill holes at the marked hole locations. Fasteners are to be provided by the installer, so hole size will be determined by size of fastener chosen. If studs cannot be accessed, then appropriate drywall plugs or butterfly bolts should be used. If the end of the wall rail is further than 3" from a stud, toggle bolts must be fastened through holes 1 and 3. Fasten the mounting rail to the wall ensuring that it is level.

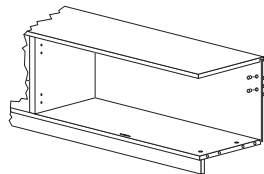

Remove the black plugs located on the inside face of the back panel to gain access to the adjusting screws on the hanging brackets. Hang the overhead on the mounting rail. The hanging brackets provide vertical and plumb adjusting screws. Level the cabinet by using these screws. All brackets must be adjusted so that they all support the cabinet.

When leveling of the overhead is complete, insert the black plugs in the holes to cover the adjusting screws.

SUGGESTED CONFIGURATIONS

EFFECTIVE MARCH 1, 2008 A PRICE INCREASE OF 5% WILL APPLY TO ALL PRODUCTS IN THIS PRICE LIST

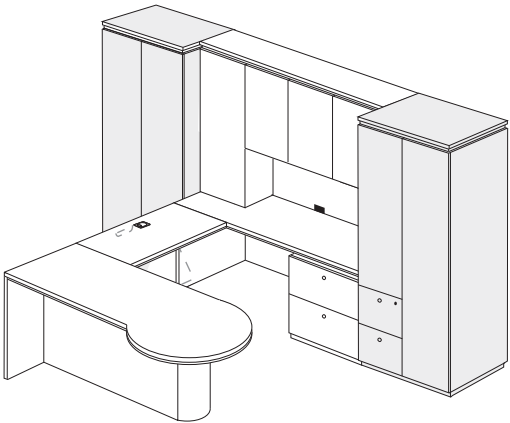

Model	Cherry Maple
93PD-8430L-4-DBM	3175
93LUY-4224-H	1376
93C-8424-XLORF	3580
93HTPR-8415-53-L110HR0-W	5632
Total List	13763
93WR-302483-19	3322
93ST-302483-04	4325
Total List with Storage	21410

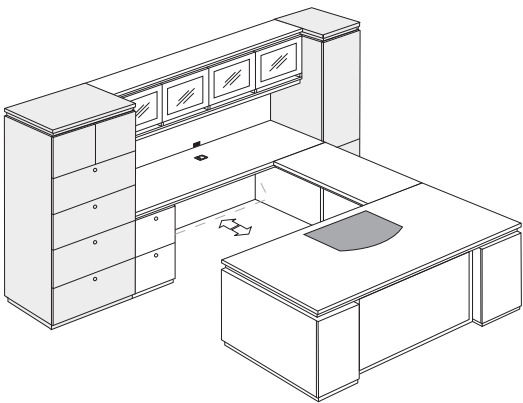
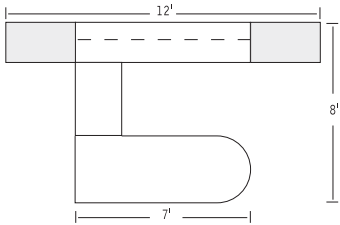

Model	Cherry Maple
93DBF-7236-4-LORF	3765
Leather Inlay	1000
Special Veneer Upcharge	200
93LU-4224-HX	1250
93CY-7224-4-LDRO	3583
93HTPM-7215-40GW	4056
Total List	13854
93ST-362470-07	4448
93WR-192470-22L	2862
Total List with Storage	21164

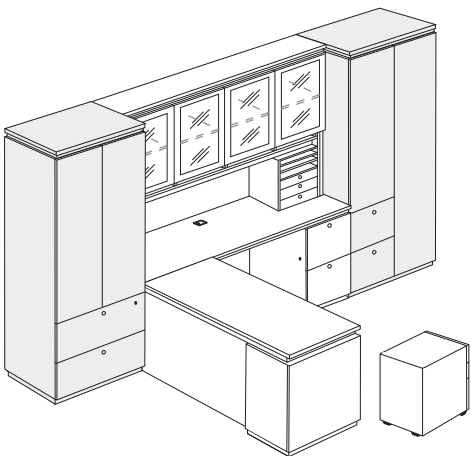
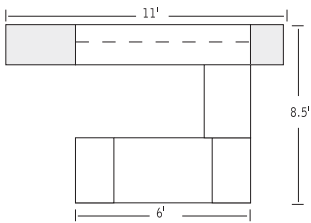

Model	Cherry Maple
93RH-7224-XL4F	2956
93C-8424-4-XLORD	3360
93HTPM-8415-53G	5503
93PM-171318-01	917
93MP-162028-4F	1443
Total List	14179
93ST-302483-04	4325
93WR-302483-14	4302
Total List with Storage	22806

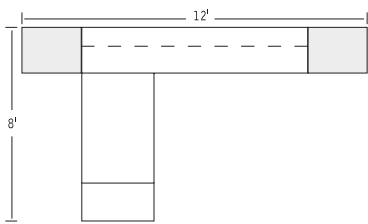

SUGGESTED CONFIGURATIONS

EFFECTIVE MARCH 1, 2008 A PRICE INCREASE OF 5% WILL APPLY TO ALL PRODUCTS IN THIS PRICE LIST

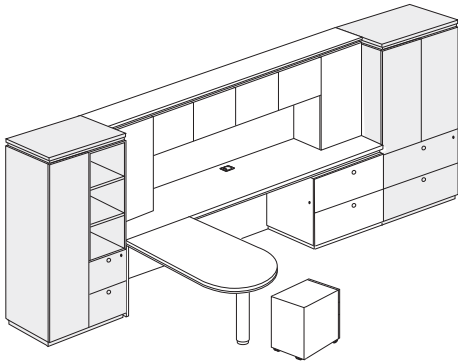

Model	Cherry Maple
93BR-7230	1609
93C-9624-XLORF	3620
93HTPR-9615-40-L110HR11	6912
93MP-162028-4F	1443
Total List	13584
93ST-362470-04	4168
93WR-302470-28	3668
Total List with Storage	21420

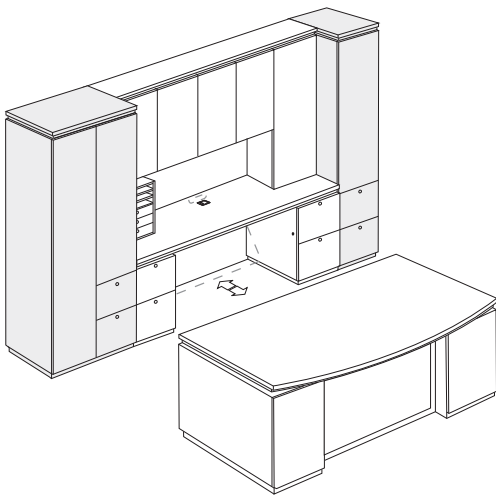
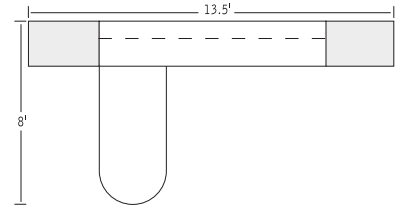

Model	Cherry Maple
93DBF-8436-4-LFRD-CD	5047
Special Veneer Upcharge	200
BT-93D-8436	494
93CY-8424-4-LDRD	3976
93HTPR-8415-53-L00HR11	5512
93PM-171320-01	954
Total List	16183
93ST-192483-91R	2940
93WR-302483-15	4302
Total List with Storage	23425

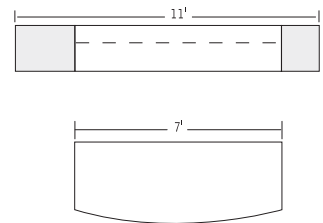

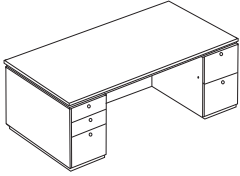
Description	Model	Maple Cherry	W	D	H	KW	Shipping Weight	Cubic Feet
	93D-6630-4-LDRD	4096	65.75	30.25	30.5	34.25	355	49
	LDRF							
	LFRD							
	LFRF							
	93D-6636-4-LDRD	4114	65.75	36.25	30.5	34.25	380	57
	LDRF							
	LFRD							
	LFRF							
	93D-7230-4-LDRD	4123	71.75	30.25	30.5	40.25	373	53
	LDRF							
	LFRD							
	LFRF							
93D-7236-4-LDRD	4175	71.75	36.25	30.5	40.25	400	62	
LDRF								
LFRD*								
LFRF								
93D-7830-4-LDRD	4205	77.75	30.25	30.5	46.25	390	57	
LDRF								
LFRD								
LFRF								
93D-7836-4-LDRD	4230	77.75	36.25	30.5	46.25	420	67	
LDRF								
LFRD								
LFRF								
93D-8430-4-LDRD	4239	83.75	30.25	30.5	52.25	408	61	
LDRF								
LFRD								
LFRF								
93D-8436-4-LDRD	4247	83.75	36.25	30.5	52.25	445	71.5	
LDRF								
LFRD								
LFRF								

DIMENSION KEY

- W — width
- D — depth
- H — height of worksurface
- KW — kneehole width

Dimensions are in inches and approximate.
Contact Customer Service if dimensions are critical.

*Indicates model illustrated by line drawing.

CODE DESCRIPTION

- 4 — full height pedestal
- D — 2 file drawers
- F — 2 box, 1 file drawer
- L — left-hand pedestal position
- R — right-hand pedestal position

STANDARD FINISHES

For a complete list of standard wood finishes please see page 4.

BOW FRONT DESKS

For bow top option, please refer to page 28.

CENTER DRAWER OPTION

For center drawer option please add "CD" to the model number and add \$350 list upcharge.

DESKS

EFFECTIVE MARCH 1, 2008 A PRICE INCREASE OF 5% WILL APPLY TO ALL PRODUCTS IN THIS PRICE LIST

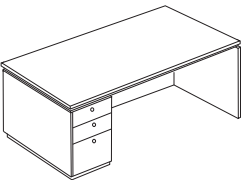
Description	Model	Maple Cherry	W	D	H	KW	Shipping Weight	Cubic Feet
	93D-6630-4-LDRO	3231	65.75	30.25	30.5	48.75	310	49
	LORD							
	LFRO							
	LORF							
	93D-6636-4-LDRO	3258	65.75	36.25	30.5	48.75	350	57
	LORD							
	LFRO							
	LORF							
	93D-7230-4-LDRO	3265	71.75	30.25	30.5	54.75	330	53
	LORD							
	LFRO							
	LORF							
	93D-7236-4-LDRO	3315	71.75	36.25	30.5	54.75	370	62
	LORD							
	LFRO*							
	LORF							
93D-7830-4-LDRO	3355	77.75	30.25	30.5	60.75	348	57	
LORD								
LFRO								
LORF								
93D-7836-4-LDRO	3374	77.75	36.25	30.5	60.75	390	67	
LORD								
LFRO								
LORF								
93D-8430-4-LDRO	3393	83.75	30.25	30.5	65.75	366	61	
LORD								
LFRO								
LORF								
93D-8436-4-LDRO	3412	83.75	36.25	30.5	65.75	410	71.5	
LORD								
LFRO								
LORF								

ORDERING PROCEDURE

To order, please specify the following:

- 1) Krug product model number
- 2) Wood species and finish, see page 4
- 3) Edge Profile, see page 13

*Indicates model illustrated by line drawing.

CODE DESCRIPTION

- 0 — no pedestal
- 4 — full height pedestal
- D — 2 file drawers
- F — 2 box, 1 file drawer
- L — left-hand pedestal position
- R — right-hand pedestal position

LEATHER INSERTS







Leather inserts are available on all desks at an upcharge of \$1000 list.

WIRING GROMMETS

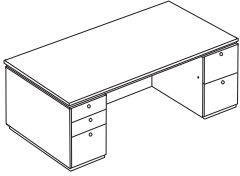
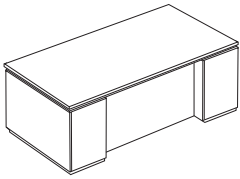
One wiring grommet in standard position is optional at no charge. Additional wiring grommets are available at an upcharge of \$100 list. See pages 15 and 16 for more wiring grommet information.

MODESTY PANELS

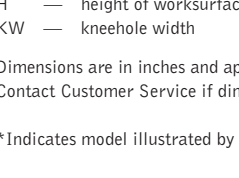
Anigre, figured cherry or birdseye maple modesty panels are available. See page 17.

Description	Model	Maple Cherry	W	D	H	KW	Shipping Weight	Cubic Feet
Double pedestal desk breakfront modesty panel	93DBF-6630-4-LDRD	4520	65.75	30.25	30.5	34.25	355	49
	LDRF							
	LFRD							
	93DBF-6636-4-LDRD	4566	65.75	36.25	30.5	34.25	380	57
	LDRF							
	LFRF							
	93DBF-7230-4-LDRD	4581	71.75	30.25	30.5	40.25	373	53
	LDRF							
	LFRD							
	93DBF-7236-4-LDRD	4628	71.75	36.25	30.5	40.25	400	62
	LDRF							
	LFRD*							
	93DBF-7830-4-LDRD	4634	77.75	30.25	30.5	46.25	390	57
	LDRF							
	LFRD							
	93DBF-7836-4-LDRD	4680	77.75	36.25	30.5	46.25	420	67
	LDRF							
	LFRD							
	93DBF-8430-4-LDRD	4689	83.75	30.25	30.5	52.25	408	61
	LDRF							
	LFRD							
	93DBF-8436-4-LDRD	4697	83.75	36.25	30.5	52.25	445	71.5
	LDRF							
	LFRD							
	LDRF							
	LFRD							
	LFRF							

DIMENSION KEY

- W — width
- D — depth
- H — height of worksurface
- KW — kneehole width

Dimensions are in inches and approximate.
Contact Customer Service if dimensions are critical.

*Indicates model illustrated by line drawing.

CODE DESCRIPTION

- 4 — full height pedestal
- D — 2 file drawers
- F — 2 box, 1 file drawer
- L — left-hand pedestal position
- R — right-hand pedestal position

STANDARD FINISHES

For a complete list of standard wood finishes please see page 4.

BOW FRONT DESKS

For bow top option, please refer to page 28.

LOCKS

Locks are standard on all pedestals and lateral file drawers, with the exception of bookcase pedestals.

DESKS

EFFECTIVE MARCH 1, 2008 A PRICE INCREASE OF 5% WILL APPLY TO ALL PRODUCTS IN THIS PRICE LIST

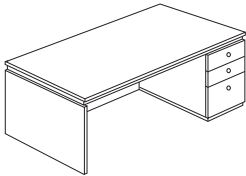
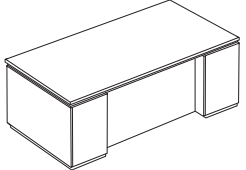
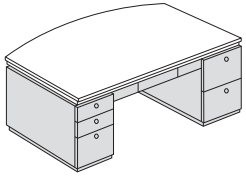
Description	Model	Maple Cherry	W	D	H	KW	Shipping Weight	Cubic Feet
Single pedestal desk breakfront modesty panel 	93DBF-6630-4-LDR0	3671	65.75	30.25	30.5	48.75	319	49
	LORD							
	LFR0							
	93DBF-6636-4-LDR0	3707	65.75	36.25	30.5	48.75	356	57
	LORD							
	LFR0							
	93DBF-7230-4-LDR0	3726	71.75	30.25	30.5	54.75	337	53
	LORD							
	LFR0							
	93DBF-7236-4-LDR0	3765	71.75	36.25	30.5	54.75	376	62
	LORD							
	LFR0							
	93DBF-7830-4-LDR0	3785	77.75	30.25	30.5	60.75	354	57
	LORD							
	LFR0							
	93DBF-7836-4-LDR0	3823	77.75	36.25	30.5	60.75	397	67
	LORD							
	LFR0							
	93DBF-8430-4-LDR0	3843	83.75	30.25	30.5	65.75	372	61
	LORD							
	LFR0							
	93DBF-8436-4-LDR0	3864	83.75	36.25	30.5	65.75	417	71.5
	LORD							
	LFR0							
	BT-93D-6630	413	-	-	-	-	-	57
	BT-93D-6636	433	-	-	-	-	-	65
	BT-93D-7230*	451	-	-	-	-	-	62
	BT-93D-7236	462	-	-	-	-	-	70.5
	BT-93D-7830	476	-	-	-	-	-	67
	BT-93D-7836	481	-	-	-	-	-	76
	BT-93D-8430	490	-	-	-	-	-	71.5
	BT-93D-8436	494	-	-	-	-	-	81.5
ORDERING NOTES								
For bow top option, please add "BT" to model number and add appropriate list upcharge.								
Bow tops add 6" to the depth of the top at its widest point and 15 lbs. to the shipping weight of the desk.								

ORDERING PROCEDURE

To order, please specify the following:

- 1) Krug product model number
- 2) Wood species and finish, see page 4
- 3) Edge Profile, see page 13

*Indicates model illustrated by line drawing.

CODE DESCRIPTION

- 4 — full height pedestal
- BT — bow top
- D — 2 file drawers
- F — 2 box, 1 file drawer
- L — left-hand pedestal position
- R — right-hand pedestal position

CENTER DRAWER OPTION

For center drawer option please add "CD" to model number and add \$350 list upcharge.

LEATHER INSERTS

Leather inserts are available on all desks at an upcharge of \$1000 list.

WIRING GROMMETS

One wiring grommet in standard position is optional at no charge. Additional wiring grommets are available at an upcharge of \$100 list. See pages 15 and 16 for more wiring grommet information.

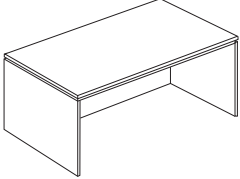
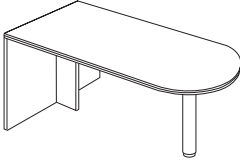
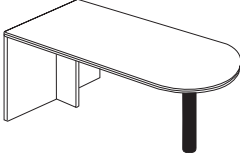
Description	Model	Maple Cherry	W	D	H	KW	Shipping Weight	Cubic Feet	
	93S-6636-4-LORO	2273	65.75	36.25	30.5	63	314	57	
	93S-7236-4-LORO	2394	71.75	36.25	30.5	69	324	62	
	93S-7836-4-LORO*	2538	77.75	36.25	30.5	75	344	67	
	93S-8436-4-LORO	2682	83.75	36.25	30.5	81	364	71.5	
	Bullet desk wood leg	93BD-6630	2082	65.75	30.25	30.5	46.5	175	49
		93BD-6636	2200	65.75	36.25	30.5	42.75	210	57
		93BD-7230	2219	71.75	30.25	30.5	51.75	190	53
		93BD-7236*	2262	71.75	36.25	30.5	48.75	223	62
		93BD-7836	2316	77.75	36.25	30.5	65	231	54.5
	Bullet desk metal leg	93BD-6630-ML	2024	65.75	30.25	30.5	45.75	179	49
		93BD-6636-ML	2046	65.75	36.25	30.5	42.75	210	57
		93BD-7230-ML	2064	71.75	30.25	30.5	51.75	190	53
		93BD-7236-ML*	2107	71.75	36.25	30.5	48.75	223	62

DIMENSION KEY

- W — width
- D — depth
- H — height of worksurface
- KW — kneehole width

Dimensions are in inches and approximate.
Contact Customer Service if dimensions are critical.

*Indicates model illustrated by line drawing.

CODE DESCRIPTION

- 0 — no pedestal
- 4 — full height pedestal
- L — left-hand support position
- R — right-hand support position
- LGM — wood leg and modesty panel
- ML — metal column leg

STANDARD FINISHES

For a complete list of standard wood finishes please see page 4.

COLUMN LEGS

All curvilinear desk column legs are 6" in diameter. The wood column leg is accented by a brushed nickel base detail.

EFFECTIVE MARCH 1, 2008 A PRICE INCREASE OF 5% WILL APPLY TO ALL PRODUCTS IN THIS PRICE LIST

CURVILINEAR DESKS

EFFECTIVE MARCH 1, 2008 A PRICE INCREASE OF 5% WILL APPLY TO ALL PRODUCTS IN THIS PRICE LIST

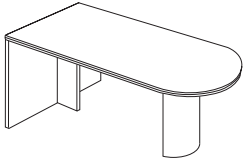
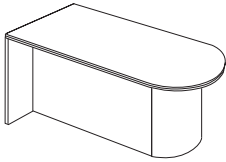
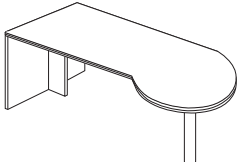
Description	Model	Maple Cherry	W	D	H	KW	Shipping Weight	Cubic Feet		
	Bullet desk half drum base	93BD-6630-DB	2218	65.75	30.25	30.5	49	228	49	
		93BD-6636-DB	2234	65.75	36.25	30.5	46	258	57	
		93BD-7230-DB	2250	71.75	30.25	30.5	55	239	53	
		93BD-7236-DB*	2297	71.75	36.25	30.5	52	272	62	
	Bullet desk half drum base full modesty panel	93BD-6630L-4-DBM R-4-DBM	2497	65.75	30.25	30.5	49	248	49	
		93BD-6636L-4-DBM R-4-DBM	2514	65.75	36.25	30.5	46.5	278	57	
		93BD-7230L-4-DBM R-4-DBM	2528	71.75	30.25	30.5	55	262	53	
		93BD-7236L-4-DBM* R-4-DBM	2553	71.75	36.25	30.5	52.5	299	62	
		93BD-7830L-4-DBM R-4-DBM	2571	77.75	30.25	30.5	61	276	57	
		93BD-7836L-4-DBM R-4-DBM	2591	77.75	36.25	30.5	58	314	67	
		93BD-8430L-4-DBM R-4-DBM	2616	83.75	30.25	30.5	67	291	61	
		93BD-8436L-4-DBM R-4-DBM	2636	83.75	36.25	30.5	64	329	71.5	
		P desk wood leg	93PD-6630L R	2615	65.75	30.25/ 36.25	30.5	43.75	220	57
			93PD-6636L R	2665	65.75	36.25/ 41.75	30.5	41	240	65
		93PD-7230L R	2745	71.75	30.25/ 36.25	30.5	49.75	200	62	
		93PD-7236L* R	2799	71.75	36.25/ 41.75	30.5	47	235	70.5	
		93PD-8430L R	2875	83.75	30.25/ 36.25	30.5	62	225	71.5	
		93PD-8436L R	2928	83.75	36.25/ 41.75	30.5	59	265	81.5	

ORDERING PROCEDURE

To order, please specify the following:

- 1) Krug product model number
- 2) Wood species and finish, see page 4
- 3) Edge Profile, see page 13

*Indicates model illustrated by line drawing.

CODE DESCRIPTION

DB — drum base
 DBM — drum base with full height modesty panel
 L — left-hand pedestal position
 R — right-hand pedestal position

STANDARD FINISHES

For a complete list of standard wood finishes please see page 4.

COLUMN LEGS

All curvilinear desk column legs are 6" in diameter. The wood column leg is accented by a brushed nickel base detail.

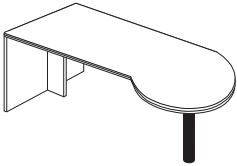
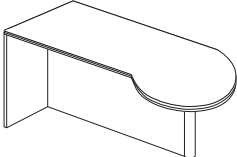
Description	Model	Maple Cherry	W	D	H	KW	Shipping Weight	Cubic Feet
	93PD-6630L-ML	2461	65.75	30.25/	30.5	43.5	220	57
	R-ML			36.25				
	93PD-6636L-ML	2510	65.75	36.25/	30.5	41	240	65
	R-ML			41.75				
	93PD-7230L-ML	2590	71.75	30.25/	30.5	49.75	200	62
	R-ML			36.25				
	93PD-7236L-ML*	2644	71.75	36.25/	30.5	47	235	70.5
	R-ML			41.75				
	93PD-8430L-ML	2720	83.75	30.25/	30.5	62	225	71.5
	R-ML			36.25				
93PD-8436L-ML	2774	83.75	36.25/	30.5	59	265	81.5	
R-ML			41.75					
	93PD-6636L-4-LGM	2887	65.75	36.25/	30.5	43.5	230	65
	R-4-LGM			41.75				
	93PD-7236L-4-LGM*	3032	71.75	36.25/	30.5	49.5	240	70.5
	R-4-LGM			41.75				
	93PD-7836L-4-LGM	3095	77.75	36.25/	30.5	52	264	68
	R-4-LGM			41.75				
93PD-8436L-4-LGM	3157	83.75	36.25/	30.5	61.5	255	81.5	
R-4-LGM			41.75					

DIMENSION KEY

W — width
 D — depth
 H — height of worksurface
 KW — kneehole width

Dimensions are in inches and approximate.
 Contact Customer Service if dimensions are critical.

*Indicates model illustrated by line drawing.

CODE DESCRIPTION

4 — full height modesty panel
 L — left-hand support position
 R — right-hand support position
 LGM — wood column leg and modesty panel
 ML — metal column leg

WIRING GROMMETS

One wiring grommet in standard position is optional at no charge. Additional wiring grommets are available at an upcharge of \$100 list. See pages 15 and 16 for more wiring grommet information.

EFFECTIVE MARCH 1, 2008 A PRICE INCREASE OF 5% WILL APPLY TO ALL PRODUCTS IN THIS PRICE LIST

CURVILINEAR DESKS

EFFECTIVE MARCH 1, 2008 A PRICE INCREASE OF 5% WILL APPLY TO ALL PRODUCTS IN THIS PRICE LIST

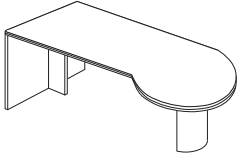
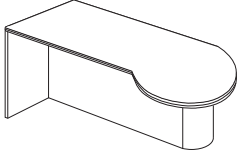
Description	Model	Maple Cherry	W	D	H	KW	Shipping Weight	Cubic Feet	
	93PD-6630L-DB	2731	65.75	30.25/ 36.25	30.5	46.5	240	57	
	93PD-6636L-DB	2787	65.75	36.25/ 41.75	30.5	43.5	272	65	
	93PD-7230L-DB	2818	71.75	30.25/ 36.25	30.5	52.5	252	62	
	93PD-7236L-DB*	2876	71.75	36.25/ 41.75	30.5	49.5	290	70.5	
	93PD-8430L-DB	2967	83.75	30.25/ 36.25	30.5	64.5	276	71.5	
	93PD-8436L-DB	2992	83.75	36.25/ 41.75	30.5	61.5	315	81.5	
		R-DB							
	93PD-6630L-4-DBM	2922	65.75	30.25/ 36.25	30.5	46.5	260	57	
	93PD-6636L-4-DBM	2982	65.75	36.25/ 41.75	30.5	43.5	290	65	
	93PD-7230L-4-DBM	3016	71.75	30.25/ 36.25	30.5	52.5	276	62	
	93PD-7236L-4-DBM*	3077	71.75	36.25/ 41.75	30.5	49.5	310	70.5	
	93PD-7830L-4-DBM	3108	77.75	36.25/ 41.75	30.5	58.5	291	67	
	93PD-7836L-4-DBM	3138	77.75	36.25/ 41.75	30.5	55.5	319	76	
	93PD-8430L-4-DBM	3175	83.75	30.25/ 36.25	30.5	64.5	305	71.5	
	93PD-8436L-4-DBM	3201	83.75	36.25/ 41.75	30.5	61.5	340	81.5	
		R-4-DBM							

ORDERING PROCEDURE

To order, please specify the following:

- 1) Krug product model number
- 2) Wood species and finish, see page 4
- 3) Edge Profile, see page 13

*Indicates model illustrated by line drawing.

CODE DESCRIPTION

- 4 — full height modesty panel
- DB — drum base
- DBM — drum base with full height modesty panel
- L — left-hand support position
- R — right-hand support position

STANDARD FINISHES

For a complete list of standard wood finishes please see page 4.

COLUMN LEGS

All curvilinear desk column legs are 6" in diameter. The wood column leg is accented by a brushed nickel base detail.

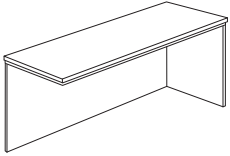
Description	Model	Maple Cherry	W	D	H	KW	Shipping Weight	Cubic Feet	
	Open return full modesty panel	93RH-4220-XL	1448	42	20	30.5	41	105	23
		XR							
		93RH-4224-XL	1482	42	24	30.5	41	120	26.5
		XR							
		93RH-4820-XL	1518	48	20	30.5	47	116	26
		XR							
		93RH-4824-XL	1551	48	24	30.5	47	133	30
		XR							
		93RH-5420-XL	1571	53.75	20	30.5	52.75	126	28.5
		XR*							
		93RH-5424-XL	1599	53.75	24	30.5	52.75	145	33.5
		XR							
		93RH-6020-XL	1618	59.75	20	30.5	58.75	137	31.5
		XR							
		93RH-6024-XL	1641	59.75	24	30.5	58.75	157	36.5
		XR							
		93RH-6620-XL	1682	65.75	20	30.5	64.75	147	34.5
		XR							
	93RH-6624-XL	1715	65.75	24	30.5	64.75	169	40	
	XR								
	93RH-7220-XL	1745	71.75	20	30.5	70.75	158	37.5	
	XR								
	93RH-7224-XL	1777	71.75	24	30.5	70.75	181	43.5	
	XR								
	93RH-8420-XL	1808	83.75	20	30.5	82	158	43	
	XR								
	93RH-8424-XL	1839	83.75	24	30.5	82	172	50.5	
	XR								

ORDERING NOTES

A half gable is required for any worksurface that has an unsupported fixed modesty panel span greater than 60”.

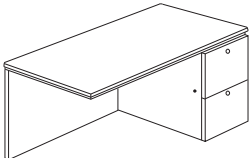
	Single pedestal return full modesty panel	93RH-4220-XL4D	2313	42	20	30.5	26.25	160	23
		XR4D							
		XL4F							
		XR4F							
		93RH-4224-XL4D	2381	42	24	30.5	26.25	176	26.5
		XR4D*							
		XL4F							
		XR4F							

DIMENSION KEY

- W — width
- D — depth
- H — height of worksurface
- KW — knee-hole width

Dimensions are in inches and approximate.
Contact Customer Service if dimensions are critical.

*Indicates model illustrated by line drawing.

CODE DESCRIPTION

- D — 2 file drawers
- F — 2 box, 1 file drawer
- H — desk height
- L — left-hand pedestal position
- R — right-hand pedestal position
- X — includes modesty panel

MODULAR PEDESTAL

Please see page 56 for modular pedestals to be used in conjunction with open returns.

WIRING GROMMETS

One wiring grommet in standard position is optional at no charge. Additional wiring grommets are available at an upcharge of \$100 list. See pages 15 and 16 for more wiring grommet information.

EFFECTIVE MARCH 1, 2008 A PRICE INCREASE OF 5% WILL APPLY TO ALL PRODUCTS IN THIS PRICE LIST

RETURNS

EFFECTIVE MARCH 1, 2008 A PRICE INCREASE OF 5% WILL APPLY TO ALL PRODUCTS IN THIS PRICE LIST

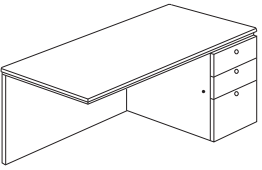
Description	Model	Maple Cherry	W	D	H	KW	Shipping Weight	Cubic Feet
Single pedestal return full modesty panel c o n t i n u e d	93RH-4820-XL4D	2449	48	20	30.5	32.25	171	26
	XR4D XL4F XR4F							
	93RH-4824-XL4D	2520	48	24	30.5	32.25	188	30
	XR4D XL4F XR4F							
	93RH-5420-XL4D	2542	53.75	20	30.5	38	181	28.5
	XR4D XL4F XR4F							
	93RH-5424-XL4D	2572	53.75	24	30.5	38	200	33.5
	XR4D XL4F XR4F							
	93RH-6020-XL4D	2627	59.75	20	30.5	44	192	31.5
	XR4D XL4F XR4F							
	93RH-6024-XL4D	2675	59.75	24	30.5	44	212	36.5
	XR4D XL4F XR4F*							
	93RH-6620-XL4D	2758	65.75	20	30.5	50	203	34.5
	XR4D XL4F XR4F							
	93RH-6624-XL4D	2841	65.75	24	30.5	50	224	40
	XR4D XL4F XR4F							
	93RH-7220-XL4D	2934	71.75	20	30.5	56	214	37.5
	XR4D XL4F XR4F							
	93RH-7224-XL4D	2956	71.75	24	30.5	56	237	43.5
	XR4D XL4F XR4F							

ORDERING PROCEDURE

To order, please specify the following:

- 1) Krug product model number
- 2) Wood species and finish, see page 4
- 3) Edge Profile, see page 13

*Indicates model illustrated by line drawing.

CODE DESCRIPTION

- D — 2 file drawers
- F — 2 box, 1 file drawer
- H — desk height pedestal
- L — left-hand pedestal position
- R — right-hand pedestal position
- X — includes modesty panel

STANDARD FINISHES

For a complete list of standard wood finishes please see page 4.

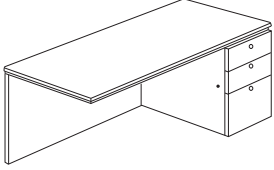
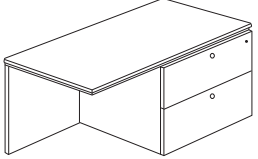
Description	Model	Maple Cherry	W	D	H	KW	Shipping Weight	Cubic Feet
Single pedestal return full modesty panel c o n t i n u e d	93RH-8420-XL4D XR4D XL4F XR4F	3059	83.75	20	30.5	68	235	43
	93RH-8424-XL4D XR4D XL4F XR4F*	3070	83.75	24	30.5	68	261	50.5
Lateral file return full modesty panel	93RH-6020-XLLF36 XRLF36	3226	59.75	20	30.5	23.75	225	31.5
	93RH-6024-XLLF36 XRLF36	3235	59.75	24	30.5	23.75	250	36.5
	93RH-6620-XLLF36 XRLF36	3243	65.75	20	30.5	29.75	234	34.5
	93RH-6624-XLLF36 XRLF36	3252	65.75	24	30.5	29.75	262	40
	93RH-7220-XLLF36 XRLF36	3261	71.75	20	30.5	35.75	245	37.5
	93RH-7224-XLLF36 XRLF36*	3269	71.5	24	30.5	35.75	275	43.5
	93RH-7820-XLLF36 XRLF36	3273	77.75	20	30.5	42	255	40
	93RH-7824-XLLF36 XRLF36	3287	77.75	24	30.5	42	287	47
	93RH-8420-XLLF36 XRLF36	3295	83.75	20	30.5	47.75	266	43
	93RH-8424-XLLF36 XRLF36	3303	83.75	24	30.5	47.75	299	50.5

DIMENSION KEY

- W — width
- D — depth
- H — height of worksurface
- KW — kneehole width

Dimensions are in inches and approximate.
Contact Customer Service if dimensions are critical.

*Indicates model illustrated by line drawing.

CODE DESCRIPTION

- H — desk height pedestal
- D — 2 file drawers
- F — 2 box, 1 file drawer
- LF — lateral file
- L — left-hand pedestal position
- R — right-hand pedestal position
- X — includes a modesty panel

WIRING GROMMETS

One rectangular grommet in a standard position is optional at no charge. Additional rectangular grommets are available at an upcharge of \$100 list. See pages 15 and 16 for more wiring grommet information.

LOCKS

Locks are standard on all pedestals and lateral file drawers, with the exception of bookcase pedestals.

EFFECTIVE MARCH 1, 2008 A PRICE INCREASE OF 5% WILL APPLY TO ALL PRODUCTS IN THIS PRICE LIST

RETURNS

EFFECTIVE MARCH 1, 2008 A PRICE INCREASE OF 5% WILL APPLY TO ALL PRODUCTS IN THIS PRICE LIST

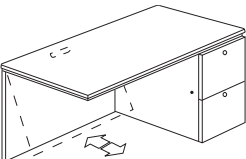
Description	Model	Maple Cherry	W	D	H	KW	Shipping Weight	Cubic Feet
Single pedestal return hinged modesty panel 	93RHY-4220-L4D	2545	42	20	30.5	26.25	160	23
	R4D							
	L4F							
	R4F							
	93RHY-4224-L4D	2620	42	24	30.5	26.25	176	26.5
	R4D							
	L4F							
	R4F							
	93RHY-4820-L4D	2697	48	20	30.5	32.25	171	26
	R4D							
	L4F							
	R4F							
	93RHY-4824-L4D	2772	48	24	30.5	32.25	188	30
	R4D							
	L4F							
R4F								
93RHY-5420-L4D	2795	53.75	20	30.5	38	181	28.5	
R4D								
L4F								
R4F								
93RHY-5424-L4D	2829	53.75	24	30.5	38	200	33.5	
R4D								
L4F								
R4F								
93RHY-6020-L4D	2890	59.75	20	30.5	44	192	31.5	
R4D								
L4F								
R4F								
93RHY-6024-L4D	2942	59.75	24	30.5	44	212	36.5	
R4D*								
L4F								
R4F								
93RHY-6620-L4D	3090	65.75	20	30.5	50	203	34.5	
R4D								
L4F								
R4F								
93RHY-6624-L4D	3126	65.75	24	30.5	50	224	40	
R4D								
L4F								
R4F								

ORDERING PROCEDURE

To order, please specify the following:

- 1) Krug product model number
- 2) Wood species and finish, see page 4
- 3) Edge Profile, see page 13

*Indicates model illustrated by line drawing.

CODE DESCRIPTION

- H — desk height pedestal
- D — 2 file drawers
- F — 2 box, 1 file drawer
- Y — hinged wood modesty panel
- L — left-hand pedestal position
- R — right-hand pedestal position

STANDARD FINISHES

For a complete list of standard wood finishes please see page 4.

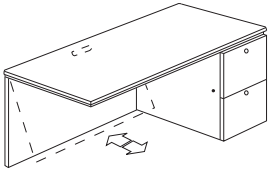
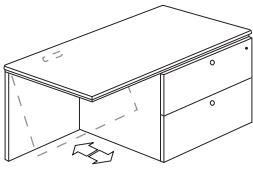
Description	Model	Maple Cherry	W	D	H	KW	Shipping Weight	Cubic Feet
Single pedestal return hinged modesty panel c o n t i n u e d 	93RHY-7220-L4D	3227	71.75	20	30.5	56	214	37.5
	R4D							
	L4F							
	R4F							
	93RHY-7224-L4D	3251	71.75	24	30.5	56	237	43.5
	R4D*							
	L4F							
	R4F							
	93RHY-8420-L4D	3366	83.75	20	30.5	68	235	43
	R4D							
	L4F							
	R4F							
93RHY-8424-L4D	3377	83.75	24	30.5	68	261	50.5	
R4D								
L4F								
R4F								
Lateral file return hinged modesty panel 	93RHY-6020-LLF36	3548	59.75	20	30.5	23.75	225	31.5
	RLF36							
	93RHY-6024-LLF36	3559	59.75	24	30.5	23.75	250	36.5
	RLF36							
	93RHY-6620-LLF36	3568	65.75	20	30.5	29.75	234	34.5
	RLF36							
	93RHY-6624-LLF36	3577	65.75	24	30.5	29.75	262	40
	RLF36*							
	93RHY-7220-LLF36	3586	71.75	20	30.5	35.75	245	37.5
	RLF36							
	93RHY-7224-LLF36	3596	71.5	24	30.5	35.75	275	43.5
	RLF36							
93RHY-7820-LLF36	3602	77.75	20	30.5	42	255	40	
RLF36								
93RHY-7824-LLF36	3615	77.75	24	30.5	42	287	47	
RLF36								
93RHY-8420-LLF36	3626	83.75	20	30.5	47.75	266	43	
RLF36								
93RHY-8424-LLF36	3633	83.75	24	30.5	47.75	299	50.5	
RLF36								

DIMENSION KEY

- W — width
- D — depth
- H — height of worksurface
- KW — kneehole width

Dimensions are in inches and approximate.
 Contact Customer Service if dimensions are critical.

*Indicates model illustrated by line drawing.

CODE DESCRIPTION

- D — 2 file drawers
- F — 2 box, 1 file drawer
- H — desk height pedestal
- L — left-hand pedestal position
- R — right-hand pedestal position
- LF — lateral file
- Y — hinged wood modesty panel

WIRING GROMMETS

One rectangular grommet in a standard position is optional at no charge. Additional rectangular grommets are available at an upcharge of \$100 list. See pages 15 and 16 for more wiring grommet information.

LOCKS

Locks are standard on all pedestals and lateral file drawers, with the exception of bookcase pedestals.

EFFECTIVE MARCH 1, 2008 A PRICE INCREASE OF 5% WILL APPLY TO ALL PRODUCTS IN THIS PRICE LIST

CURVILINEAR RETURNS

EFFECTIVE MARCH 1, 2008 A PRICE INCREASE OF 5% WILL APPLY TO ALL PRODUCTS IN THIS PRICE LIST

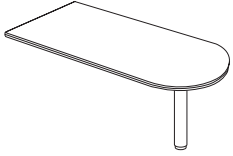
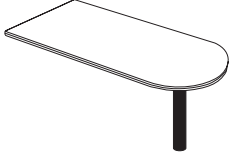
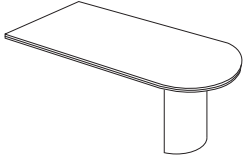
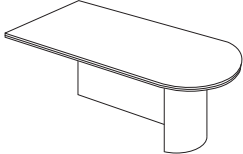
Description	Model	Maple Cherry	W	D	H	KW	Shipping Weight	Cubic Feet	
	Bullet return wood leg	93BR-6030	1457	59.75	30	30.5	41.25	109	5
		93BR-6630	1534	65.75	30	30.5	47.25	118	5.5
		93BR-6636	1572	65.75	36	30.5	44.5	135	6.25
		93BR-7230*	1609	71.75	30	30.5	53.25	125	5.75
		93BR-7236	1645	71.75	36	30.5	50.5	146	6.75
		93BR-8436	1725	83.75	36	30.5	62.5	165	7.5
	Bullet return metal leg	93BR-6030-ML	1303	59.75	30	30.5	41.25	109	5
		93BR-6630-ML	1379	65.75	30	30.5	47.25	118	5.5
		93BR-6636-ML	1417	65.75	36	30.5	44.5	135	6.25
		93BR-7230-ML*	1454	71.75	30	30.5	53.25	125	5.75
		93BR-7236-ML	1490	71.75	36	30.5	50.5	146	6.75
		93BR-8436-ML	1571	83.75	36	30.5	62.5	165	7.5
	Bullet return half drum base	93BR-6030-DB	1487	59.75	30	30.5	44.5	160	9
		93BR-6630-DB	1563	65.75	30	30.5	50.5	168	9.5
		93BR-6636-DB	1601	65.75	36	30.5	47.5	181	10.25
		93BR-7230-DB*	1639	71.75	30	30.5	56.5	175	9.75
		93BR-7236-DB	1674	71.75	36	30.5	53.5	191	10.75
		93BR-7830-DB	1725	77.75	30	30.5	62.5	185	11
	Bullet return half drum base full modesty	93BR-6030L-DBM	1747	59.75	30	30.5	44.5	205	44.5
		R-DBM							
		93BR-6630L-DBM	1822	65.75	30	30.5	50.5	220	49
		R-DBM							
		93BR-6636L-DBM	1860	65.75	36	30.5	47.5	240	57
		R-DBM							
		93BR-7230L-DBM	1898	71.75	30	30.5	56.5	233	53
		R-DBM*							
		93BR-7236L-DBM	1955	71.75	36	30.5	53.5	258	62
		R-DBM							
	93BR-8430L-DBM	2159	83.75	30	30.5	68.5	263	61	
	R-DBM								
	93BR-8436L-DBM	2262	83.75	36	30.5	65.5	290	71.5	
	R-DBM								

ORDERING PROCEDURE

To order, please specify the following:

- 1) Krug product model number
- 2) Wood species and finish, see page 4
- 3) Edge Profile, see page 13

*Indicates model illustrated by line drawing.

CODE DESCRIPTION

- 4 — full height modesty panel
- DB — drum base
- DBM — drum base with full height modesty panel
- L — left-hand support position
- R — right-hand support position
- ML — metal leg

STANDARD FINISHES

For a complete list of standard wood finishes please see page 4.

COLUMN LEGS

All curvilinear desk column legs are 6" in diameter. The wood column leg is accented by a brushed nickel base detail.

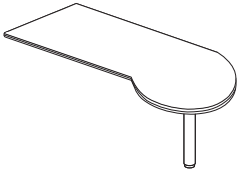
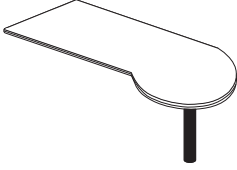
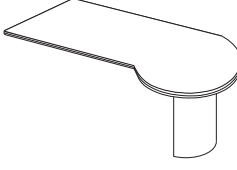
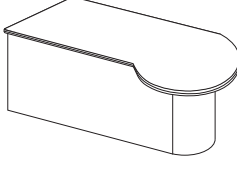
Description	Model	Maple Cherry	W	D	H	KW	Shipping Weight	Cubic Feet
	93PR-6636L R	2000	65.75	41.75	30.5	42	138	7
	93PR-7230L R	2127	71.75	36.25	30.5	57	129	6.75
	93PR-7236L* R	2253	71.75	41.25	30.5	48	150	7.5
	93PR-8430L R	2374	83.75	36.25	30.5	63	147	7.5
	93PR-8436L R	2497	83.75	41.75	30.5	60	175	8.5
	93PR-6636L-ML R-ML	1846	65.75	41.75	30.5	42	138	7
	93PR-7230L-ML R-ML	1969	71.75	36.25	30.5	57	129	6.75
	93PR-7236L-ML* R-ML	2098	71.75	41.25	30.5	48	150	7.5
	93PR-8430L-ML R-ML	2220	83.75	36.25	30.5	63	147	7.5
	93PR-8436L-ML R-ML	2342	83.75	41.75	30.5	60	175	8.5
	93PR-7230L-DB R-DB	1897	71.75	36.25	30.5	52	225	62
	93PR-7236L-DB* R-DB	2001	71.75	41.25	30.5	49.25	250	70.5
	93PR-7830L-DB R-DB	2053	77.75	36.25	30.5	58	238	67
	93PR-7836L-DB R-DB	2104	77.75	41.25	30.5	55.25	238	76
	93PR-8430L-DB R-DB	2165	83.75	36.25	30.5	64.5	249	71.5
	93PR-8436L-DB R-DB	2197	83.75	41.25	30.5	61.25	282	81.5
	93PR-7230L-DBM R-DBM	2157	71.75	36.25	30.5	52	245	62
	93PR-7236L-DBM* R-DBM	2282	71.75	41.25	30.5	49.25	270	70.5
	93PR-7830L-DBM R-DBM	2389	77.75	36.25	30.5	58	258	67
	93PR-8430L-DBM R-DBM	2511	83.75	36.25	30.5	64	272	71.5
	93PR-8436L-DBM R-DBM	2548	83.75	41.75	30.5	61.25	305	81.5

DIMENSION KEY

W — width
D — depth
H — height of worksurface
KW — knee-hole width

Dimensions are in inches and approximate.
Contact Customer Service if dimensions are critical.

*Indicates model illustrated by line drawing.

CODE DESCRIPTION

L — left-hand support position
R — right-hand support position
DB — drum base
DBM — drum base full height modesty panel
ML — metal leg

WIRING GROMMETS

One rectangular grommet in a standard position is optional at no charge. Additional rectangular grommets are available at an upcharge of \$100 list. See pages 15 and 16 for more wiring grommet information.

EFFECTIVE MARCH 1, 2008 A PRICE INCREASE OF 5% WILL APPLY TO ALL PRODUCTS IN THIS PRICE LIST

LINKING UNITS

EFFECTIVE MARCH 1, 2008 A PRICE INCREASE OF 5% WILL APPLY TO ALL PRODUCTS IN THIS PRICE LIST

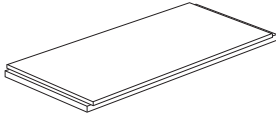
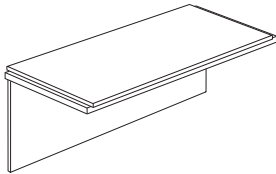
Description	Model	Maple Cherry	W	D	H	Shipping Weight	Cubic Feet
	93LU-3620-H	574	36	20	30.5	35	1.75
	93LU-3624-H	578	36	24	30.5	43	2
	93LU-4220-H	595	42	20	30.5	41	2
	93LU-4224-H	614	42	24	30.5	50	2.25
	93LU-4820-H	628	48	20	30.5	47	2.25
	93LU-4824-H*	641	48	24	30.5	56	2.25
	93LU-5420-H	648	53.75	20	30.5	52	2.5
	93LU-5424-H	654	53.75	24	30.5	63	3
	93LU-6020-H	661	59.75	20	30.5	58	2.75
	93LU-6024-H	686	59.75	24	30.5	70	3.25
	93LU-6620-H	697	65.75	20	30.5	64	3
	93LU-6624-H	710	65.75	24	30.5	77	3.5
	93LU-7220-H	721	71.75	20	30.5	70	3.25
	93LU-7224-H	733	71.75	24	30.5	85	4
	93LU-3620-HX	1158	36	20	30.5	75	3.75
	93LU-3624-HX	1194	36	24	30.5	82	3.75
	93LU-4220-HX	1209	42	20	30.5	87	4.25
	93LU-4224-HX	1250	42	24	30.5	95	4.25
	93LU-4820-HX	1275	48	20	30.5	100	4.25
	93LU-4824-HX*	1299	48	24	30.5	109	4.75
	93LU-5420-HX	1344	53.75	20	30.5	110	5.25
	93LU-5424-HX	1348	53.75	24	30.5	122	5.25
	93LU-6020-HX	1358	59.75	20	30.5	123	5.75
	93LU-6024-HX	1362	59.75	24	30.5	136	5.75
	93LU-6620-HX	1409	65.75	20	30.5	135	6.25
	93LU-6624-HX	1456	65.75	24	30.5	149	6.25
	93LU-7220-HX	1501	71.75	20	30.5	147	6.75
	93LU-7224-HX	1545	71.75	24	30.5	163	6.75
	93LU-7820-HX	1590	77.75	20	30.5	159	7.5
	93LU-7824-HX	1635	77.75	24	30.5	177	7.5
	93LU-8420-HX	1684	83.75	20	30.5	172	8
93LU-8424-HX	1723	83.75	24	30.5	190	8	

ORDERING NOTES

A half gable support is required on any open spans greater than 60" that doesn't have a modesty panel.

ORDERING PROCEDURE

To order, please specify the following:

- 1) Krug product model number
- 2) Wood species and finish, see page 4
- 3) Edge Profile, see page 13

*Indicates model illustrated by line drawing.

CODE DESCRIPTION

- H — desk height
- X — includes a modesty panel

STANDARD FINISHES

For a complete list of standard wood finishes please see page 4.

LINKING UNITS

Yorkville linking units feature an extended sub-top on the sides of the top. This creates a seamless connection to other cases.

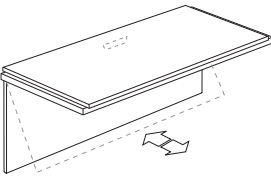
Description	Model	Maple Cherry	W	D	H	Y	Shipping Weight	Cubic Feet
Linking unit hinged modesty panel 	93LUY-3620-H	1273	36	20	30.5	-	75	3.75
	93LUY-3624-H	1313	36	24	30.5	-	82	3.75
	93LUY-4220-H	1331	42	20	30.5	-	87	4.25
	93LUY-4224-H	1376	42	24	30.5	-	95	4.25
	93LUY-4820-H	1403	48	20	30.5	-	100	4.25
	93LUY-4824-H*	1429	48	24	30.5	-	109	4.75
	93LUY-5420-H	1478	53.75	20	30.5	-	110	5.25
	93LUY-5424-H	1484	53.75	24	30.5	-	122	5.25
	93LUY-6020-H	1494	59.75	20	30.5	-	123	5.75
	93LUY-6024-H	1498	59.75	24	30.5	-	136	5.75
	93LUY-6620-H	1550	65.75	20	30.5	-	135	6.25
	93LUY-6624-H	1603	65.75	24	30.5	-	149	6.25
	93LUY-7220-H	1651	71.75	20	30.5	-	147	6.75
	93LUY-7224-H	1700	71.75	24	30.5	-	163	6.75
	93LUY-7820-H	1749	77.75	20	30.5	-	159	7.5
	93LUY-7824-H	1797	77.75	24	30.5	-	177	7.5
	93LUY-8420-H	1853	83.75	20	30.5	-	172	8
93LUY-8424-H	1895	83.75	24	30.5	-	190	8	

Corner unit straight front

93CU-3636*	2265	36	36	30.5	20	195	33.5
93CU-4242	2490	42	42	30.5	25.25	230	43

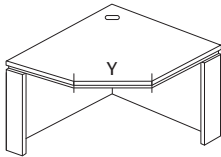

ORDERING NOTES

One rectangular grommet comes standard at the back corner in 'C' position. Additional grommets are not available.

DIMENSION KEY

W — width
D — depth
H — height of worksurface

Dimensions are in inches and approximate.
Contact Customer Service if dimensions are critical.

*Indicates model illustrated by line drawing.

CODE DESCRIPTION

H — desk height
Y — hinged wood modesty panel

WIRING GROMMETS

One rectangular grommet in a standard position is optional at no charge. Additional rectangular grommets are available at an upcharge of \$100 list. See pages 15 and 16 for more wiring grommet information.

CREDENZA SHELLS | CREDENZAS

EFFECTIVE MARCH 1, 2008 A PRICE INCREASE OF 5% WILL APPLY TO ALL PRODUCTS IN THIS PRICE LIST

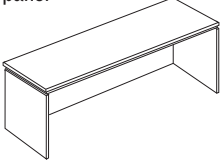
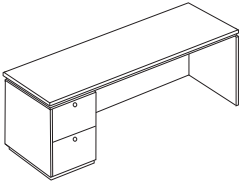
Description	Model	Maple Cherry	W	D	H	KW	Shipping Weight	Cubic Feet
Credenza shell full modesty panel 	93C-6624-4-XLOR0	1834	65.75	24	30.5	63.5	193	40
	93C-7224-4-XLOR0	1983	71.75	24	30.5	69.5	206	43.5
	93C-7824-4-XLOR0	2203	77.75	24	30.5	75.5	218	47
	93C-8424-4-XLOR0	2252	83.75	24	30.5	81.5	230	50.5
Single pedestal credenza full modesty panel 	93C-6620-4-XLDRO	3204	65.75	20	30.5	49	230	34.5
	XLORD							
	XLFRO							
	XLORF	3216	65.75	24	30.5	49	259	40
	93C-6624-4-XLDRO							
	XLORD							
	XLFRO	3231	71.75	20	30.5	55	241	37.5
	93C-7220-4-XLDRO							
	XLORD							
	XLFRO	3258	71.75	24	30.5	55	271	43.5
	93C-7224-4-XLDRO*							
	XLORD							
	XLFRO	3271	77.75	20	30.5	61	251	40
	93C-7820-4-XLDRO							
	XLORD							
	XLFRO	3287	77.75	24	30.5	61	283	47
93C-7824-4-XLDRO								
XLORD								
XLFRO	3310	83.75	20	30.5	67	262	43	
93C-8420-4-XLDRO								
XLORD								
XLFRO	3360	83.75	24	30.5	67	296	50.5	
93C-8424-4-XLDRO								
XLORD								
XLFRO								
XLORF								

ORDERING PROCEDURE

To order, please specify the following:

- 1) Krug product model number
- 2) Wood species and finish, see page 4
- 3) Edge Profile, see page 13

*Indicates model illustrated by line drawing.

CODE DESCRIPTION

- 0 — no pedestal
- 4 — full height pedestal
- D — 2 file drawers
- F — 2 box, 1 file drawer
- L — left-hand pedestal position
- R — right-hand pedestal position
- X — includes a modesty panel

STANDARD FINISHES

For a complete list of standard wood finishes please see page 4.

LOCKS

Locks are standard on all pedestals and lateral file drawers with the exception of bookcase pedestals.

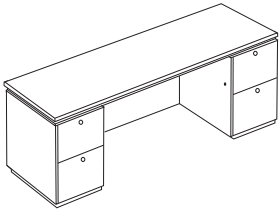
Description	Model	Maple Cherry	W	D	H	KW	Shipping Weight	Cubic Feet
 <p>Double pedestal kneehole credenza full modesty panel</p>	93C-6620-4-XLDRD	3442	65.75	20	30.5	34.25	262	34.5
	XLDRF							
	XLFRD							
	XLFRF							
	93C-6624-4-XLDRD	3447	65.75	24	30.5	34.25	294	40
	XLDRF							
	XLFRD							
	XLFRF							
	93C-7220-4-XLDRD	3476	71.75	20	30.5	40.25	273	37.5
	XLDRF							
	XLFRD							
	XLFRF							
	93C-7224-4-XLDRD*	3503	71.75	24	30.5	40.25	306	43.5
	XLDRF							
	XLFRD							
	XLFRF							
	93C-7820-4-XLDRD	3509	77.75	20	30.5	46.25	284	40
	XLDRF							
XLFRD								
XLFRF								
93C-7824-4-XLDRD	3543	77.75	24	30.5	46.25	318	47	
XLDRF								
XLFRD								
XLFRF								
93C-8420-4-XLDRD	3560	83.75	20	30.5	52.25	395	43.5	
XLDRF								
XLFRD								
XLFRF								
93C-8424-4-XLDRD	3614	83.75	24	30.5	52.25	410	50.5	
XLDRF								
XLFRD								
XLFRF								

DIMENSION KEY

- W — width
- D — depth
- H — height of worksurface
- KW — kneehole width

Dimensions are in inches and approximate.
Contact Customer Service if dimensions are critical.

*Indicates model illustrated by line drawing.

CODE DESCRIPTION

- 4 — full height pedestal
- D — 2 file drawers
- F — 2 box, 1 file drawer
- L — left-hand pedestal position
- R — right-hand pedestal position
- X — includes a modesty panel

WIRING GROMMETS

One rectangular grommet in a standard position is optional at no charge. Additional rectangular grommets are available at an upcharge of \$100 list. See pages 15 and 16 for more wiring grommet information.

CREDENZAS

EFFECTIVE MARCH 1, 2008 A PRICE INCREASE OF 5% WILL APPLY TO ALL PRODUCTS IN THIS PRICE LIST

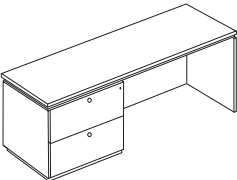
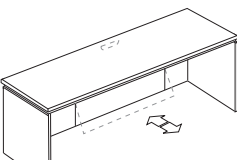
Description	Model	Maple Cherry	W	D	H	KW	Shipping Weight	Cubic Feet
Single pedestal credenza lateral file 	93C-6620-XLFRO XLORF	3250	65.75	20	30.5	29.25	254	34.5
	93C-6624-XLFRO XLORF	3325	65.75	24	30.5	29.25	287	40
	93C-7220-XLFRO XLORF	3400	71.75	20	30.5	35.25	265	37.5
	93C-7224-XLFRO* XLORF	3438	71.75	24	30.5	35.25	299	43.5
	93C-7820-XLFRO XLORF	3473	77.75	20	30.5	40.25	275	40.5
	93C-7824-XLFRO XLORF	3508	77.75	24	30.5	40.25	311	47
	93C-8420-XLFRO XLORF	3543	83.75	20	30.5	43.25	286	43.5
	93C-8424-XLFRO XLORF	3580	83.75	24	30.5	43.25	323	50.5
	93C-9624-XLFRO XLORF	3620	95.5	24	30.5	59.25	347	57
	Credenza Shell with Hinged Modesty Panel 	93SY-6620	2699	65.75	20	30.5	63.5	165
93SY-6624		2781	65.75	24	30.5	63.5	193	40
93SY-7220		2863	71.75	20	30.5	69.5	176	37.25
93SY-7224*		2905	74.75	24	30.5	69.5	206	43.5
93SY-7820		2946	77.75	20	30.5	75.5	185	40
93SY-7824		2982	77.75	24	30.5	75.5	218	47
93SY-8420		3022	83.75	20	30.5	81.5	195	43
93SY-8424		3064	83.75	24	30.5	81.5	230	50.5

ORDERING PROCEDURE

To order, please specify the following:

- 1) Krug product model number
- 2) Wood species and finish, see page 4
- 3) Edge Profile, see page 13

*Indicates model illustrated by line drawing.

CODE DESCRIPTION

- O — no pedestal
- L — left-hand pedestal position
- R — right-hand pedestal position
- X — includes a modesty panel

STANDARD FINISHES

For a complete list of standard wood finishes please see page 4.

LOCKS

Locks on bookcase pedestal doors are available at \$100 list. Please specify a time of order. All other pedestals include a standard lock.

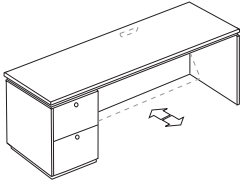
Description	Model	Maple Cherry	W	D	H	KW	Shipping Weight	Cubic Feet
 <p>Single pedestal credenza hinged modesty panel</p>	93CY-6620-4-LDRO	3525	65.75	20	30.5	49	230	34.5
	LORD							
	LFR0							
	LORF							
	93CY-6624-4-LDRO	3541	65.75	24	30.5	49	259	40
	LORD							
	LFR0							
	LORF							
	93CY-7220-4-LDRO	3555	71.75	20	30.5	55	241	37.5
	LORD							
	LFR0							
	LORF							
	93CY-7224-4-LDRO*	3583	71.75	24	30.5	55	271	43.5
	LORD							
	LFR0							
	LORF							
	93CY-7820-4-LDRO	3585	77.75	20	30.5	61	251	40
	LORD							
LFR0								
LORF								
93CY-7824-4-LDRO	3615	77.75	24	30.5	61	283	47	
LORD								
LFR0								
LORF								
93CY-8420-4-LDRO	3641	83.75	20	30.5	67	262	43	
LORD								
LFR0								
LORF								
93CY-8424-4-LDRO	3697	83.75	24	30.5	67	296	50.5	
LORD								
LFR0								
LORF								

DIMENSION KEY

W — width
D — depth
H — height of worksurface
KW — kneehole width

Dimensions are in inches and approximate.
Contact Customer Service if dimensions are critical.

*Indicates model illustrated by line drawing.

CODE DESCRIPTION

0 — no pedestal
4 — full height pedestal
D — 2 file drawers
F — 2 box, 1 file drawer
L — left-hand pedestal position
R — right-hand pedestal position
X — includes a modesty panel

WIRING GROMMETS

One rectangular grommet in a standard position is optional at no charge. Additional rectangular grommets are available at an upcharge of \$100 list. See pages 15 and 16 for more wiring grommet information.

EFFECTIVE MARCH 1, 2008 A PRICE INCREASE OF 5% WILL APPLY TO ALL PRODUCTS IN THIS PRICE LIST

CREDENZAS

EFFECTIVE MARCH 1, 2008 A PRICE INCREASE OF 5% WILL APPLY TO ALL PRODUCTS IN THIS PRICE LIST

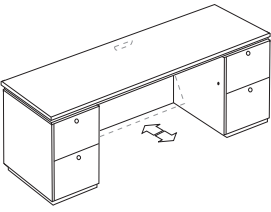
Description	Model	Maple Cherry	W	D	H	KW	Shipping Weight	Cubic Feet
 Double pedestal credenza hinged modesty panel	93CY-6620-4-LDRD	3786	65.75	20	30.5	34.25	262	34.5
	LDRF							
	LFRD							
	LFRF							
	93CY-6624-4-LDRD	3792	65.75	24	30.5	34.25	294	40
	LDRF							
	LFRD							
	LFRF							
	93CY-7220-4-LDRD	3823	71.75	20	30.5	40.25	273	37.5
	LDRF							
	LFRD							
	LFRF							
93CY-7224-4-LDRD*	3853	71.75	24	30.5	40.25	306	43.5	
LDRF								
LFRD								
LFRF								
93CY-7820-4-LDRD	3861	77.75	20	30.5	46.25	284	40	
LDRF								
LFRD								
LFRF								
93CY-7824-4-LDRD	3898	77.75	24	30.5	46.25	318	47	
LDRF								
LFRD								
LFRF								
93CY-8420-4-LDRD	3915	83.75	20	30.5	52.25	395	43.5	
LDRF								
LFRD								
LFRF								
93CY-8424-4-LDRD	3976	83.75	24	30.5	52.25	410	50.5	
LDRF								
LFRD								
LFRF								

ORDERING PROCEDURE

To order, please specify the following:

- 1) Krug product model number
- 2) Wood species and finish, see page 4
- 3) Edge Profile, see page 13

*Indicates model illustrated by line drawing.

CODE DESCRIPTION

- 4 — full height pedestal
- D — 2 file drawers
- F — 2 box, 1 file drawer
- L — left-hand pedestal position
- R — right-hand pedestal position
- Y — hinged wood modesty panel

STANDARD FINISHES

For a complete list of standard wood finishes please see page 4.

LOCKS

Locks are standard on all pedestals and lateral file drawers, with the exception of bookcase pedestals.

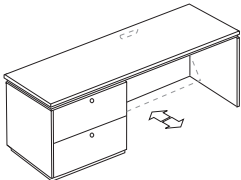
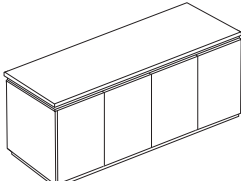
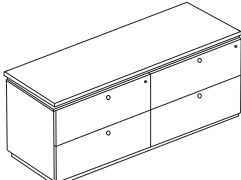
Description	Model	Maple Cherry	W	D	H	KW	Shipping Weight	Cubic Feet
Lateral file credenza hinged modesty panel 	93CY-6620-LFR0	3575	65.75	20	30.5	29.25	254	34.5
	LORF							
	93CY-6624-LFR0	3658	65.75	24	30.5	29.25	287	40
	LORF							
	93CY-7220-LFR0	3740	71.75	20	30.5	35.25	265	37.5
	LORF							
	93CY-7224-LFR0*	3781	71.75	24	30.5	35.25	299	43.5
	LORF							
	93CY-7820-LFR0	3820	77.75	20	30.5	40.25	275	40.5
	LORF							
93CY-7824-LFR0	3859	77.75	24	30.5	40.25	311	47	
LORF								
93CY-8420-LFR0	3898	83.75	20	30.5	43.25	286	43.5	
LORF								
93CY-8424-LFR0	3939	83.75	24	30.5	43.25	323	50.5	
LORF								
93CY-9624-LFR0	4372	95.5	24	30.5	59.25	347	57	
LORF								
Bookcase credenza 	93C-6620-LBRB	3521	66.75	20	30.5	-	298	34.5
	93C-6624-LBRB	3605	66.75	24	30.5	-	345	40
	93C-7220-LBRB*	3660	71.75	20	30.5	-	322	37.5
	93C-7224-LBRB	3729	71.75	24	30.5	-	374	43.5
	93C-8420-LBRB	3792	83.75	20	30.5	-	368	43.5
	93C-8424-LBRB	3863	83.75	24	30.5	-	427	50.5
Lateral file credenza 	93C-6620-LFRF	4569	66.75	20	30.5	-	405	34.5
	93C-6624-LFRF	4666	66.75	24	30.5	-	469	40
	93C-7220-LFRF*	4713	71.75	20	30.5	-	424	37.5
	93C-7224-LFRF	4790	71.75	24	30.5	-	492	43.5
	93C-8420-LFRF	4854	83.75	20	30.5	-	462	43.5
	93C-8424-LFRF	4934	83.75	24	30.5	-	536	50.5

ORDERING NOTES
 66" = 36"LF/30"LF or 30"LF/36"LF

DIMENSION KEY

- W — width
- D — depth
- H — height of worksurface
- KW — kneehole width

Dimensions are in inches and approximate.
 Contact Customer Service if dimensions are critical.

*Indicates model illustrated by line drawing.

CODE DESCRIPTION

- 4 — full height pedestal
- B — bookcase
- F — lateral file
- L — left-hand pedestal position
- R — right-hand pedestal position
- Y — hinged wood modesty panel

STANDARD FINISHES

For a complete list of standard wood finishes please see page 4.

LOCKS

Locks are standard on all pedestals and lateral file drawers, with the exception of bookcase pedestals.

EFFECTIVE MARCH 1, 2008 A PRICE INCREASE OF 5% WILL APPLY TO ALL PRODUCTS IN THIS PRICE LIST

FULL FACE | CORNER CREDENZAS

EFFECTIVE MARCH 1, 2008 A PRICE INCREASE OF 5% WILL APPLY TO ALL PRODUCTS IN THIS PRICE LIST

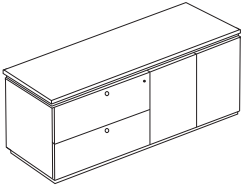
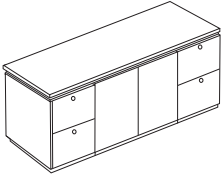
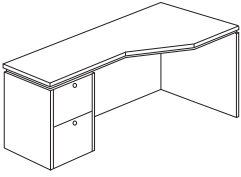
Description	Model	Maple Cherry	W	D	H	KW	Shipping Weight	Cubic Feet	
Lateral file / bookcase credenza 	93C-6620-LFRB LBRF	4031	66.75	20	30.5	-	326	34.5	
	93C-6624-LFRB LBRF	4254	66.75	24	30.5	-	469	40	
	93C-7220-LFRB* LBRF	4298	71.75	20	30.5	-	349	37.5	
	93C-7224-LFRB LBRF	4357	71.75	24	30.5	-	492	43.5	
	93C-7820-LFRB LBRF	4385	77.75	20	30.5	-	370	40.5	
	93C-8420-LFRB LBRF	4470	83.75	20	30.5	-	393	43.5	
	93C-8424-LFRB LBRF	4522	83.75	24	30.5	-	536	50.5	
	<hr/>								
Full face storage credenza 	93C-6624-DBCD	4334	65.75	24	30.5	-	363	40.5	
	93C-7224-DBCD*	4595	71.5	24	30.5	-	387	43.5	
	93C-8424-DBCD	4857	83.75	24	30.5	-	435	50.5	
<hr/>									
Corner credenza 	93CC-7220-XL4D XL4F XR4D XR4F	2760	71.75	20/30	30.5	32	261	53	
	93CC-7224-XL4D* XL4F XR4D XR4F	2816	71.75	24/36	30.5	32	295	62	
	93CC-8420-XL4D XL4F XR4D XR4F	2847	83.75	20/30	30.5	44	287	61	
	93CC-8424-XL4D XL4F XR4D XR4F	3053	83.75	20/36	30.5	44	328	71.5	
	<hr/>								

ORDERING PROCEDURE

To order, please specify the following:

- 1) Krug product model number
- 2) Wood species and finish, see page 4
- 3) Edge Profile, see page 13

*Indicates model illustrated by line drawing.

CODE DESCRIPTION

- B — bookcase
- BC — bookcase
- D — 2 file drawers
- F — when preceded in the model number by -4:
2 box, 1 file drawer
- when it directly follows the size classifier:
2 lateral file drawers
- L — left-hand pedestal position
- R — right-hand pedestal position
- X — includes a modesty panel

STANDARD FINISHES

For a complete list of standard wood finishes please see page 4.

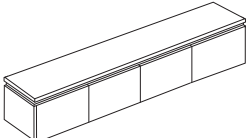
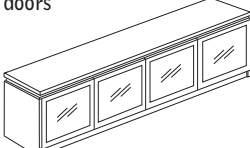
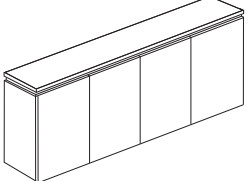
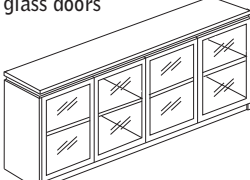
Description	Model	Maple Cherry	W	D	H	Doors	Shipping Weight	Cubic Feet
	930H-4215	1433	42	14.75	18	2	97	9
	930H-4815	1490	48	14.75	18	4	112	10
	930H-6015	1735	59.75	14.75	18	4	136	12.5
	930H-6615	1832	65.75	14.75	18	4	148	13.5
	930H-7215*	1930	71.75	14.75	18	4	160	15
	930H-4215G	1519	42	14.75	18	2	105	9
	930H-4815G*	1580	48	14.75	18	4	122	10
	930H-6015G	1840	59.75	14.75	18	4	146	12.5
	930H-6615G	1943	65.75	14.75	18	4	158	13.5
	930H-7215G	2047	71.75	14.75	18	4	170	15
	930H-361531	1720	35.75	14.75	31	2	110	12.5
	930H-421531	1791	42	14.75	31	2	125	14.5
	930H-481531*	1863	48	14.75	31	4	146	16.5
	930H-361531G	1883	35.75	14.75	31	2	119	12.5
	930H-421531G	1955	42	14.75	31	2	134	14.5
	930H-481531G*	2034	48	14.75	31	4	158	16.5

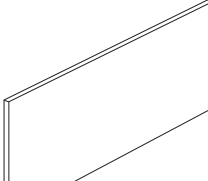
Tackboards for use with overheads	FABRIC GRADES										W	H	COM	WT
	1	2	3	4	5	6	7	8	9					
	93TB0H-42	236	318	337	418	503	580	665	766	904	41.75	23.25	2	11
	93TB0H-48	263	327	342	430	515	591	682	784	943	47.75	23.25	2	12
	93TB0H-60	298	399	418	521	626	742	858	975	1159	59.5	23.25	2	14
	93TB0H-66	327	445	476	581	696	827	941	1075	1280	65.75	23.25	2	15
	93TB0H-72	359	550	574	761	935	947	1087	1240	1446	71.5	23.25	2	17

ORDERING NOTES

Krug panel fabrics are available at grade 1 pricing. See page 6 for information.
Only Krug panel fabric tackboards are available on *KrugExpress*.

DIMENSION KEY

W — width
D — depth
H — height of worksurface

Dimensions are in inches and approximate.
Contact Customer Service if dimensions are critical.

*Indicates model illustrated by line drawing.

CODE DESCRIPTION

G — wood framed frosted glass doors
TB — tackboard

LOCKS

Locks are optional on all wood doors at an upcharge of \$100 list per set of (2) doors. Locks are not available on wood framed frosted glass doors.

OVERHEADS

All overheads include factory installed tasklights and mounting hardware.

EFFECTIVE MARCH 1, 2008 A PRICE INCREASE OF 5% WILL APPLY TO ALL PRODUCTS IN THIS PRICE LIST

HUTCHES

EFFECTIVE MARCH 1, 2008 A PRICE INCREASE OF 5% WILL APPLY TO ALL PRODUCTS IN THIS PRICE LIST

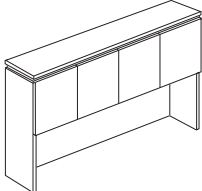
Description	Model	Maple	W	D	H	CH	Shipping Weight	Cubic Feet
		Cherry						
	93HT-6615-40	2794	65.75	14.75	39.25	23.25	197	25.5
	93HT-7215-40*	3284	71.75	14.75	39.25	23.25	210	28
	93HT-8415-40	3674	83.75	14.75	39.25	23.25	235	32.5
	93HT-9615-40	5330	95.5	14.75	39.25	23.25	286	38

ORDERING NOTES

Voice/Power/Data modules can be specified by placing a 'W' at the end of the hutch model number and applying a \$120 list upcharge. Hutches come standard with Krug panel grade 1 fabric. See page 6 for information.

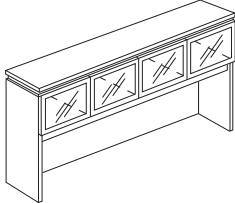
	93HT-6615-40-G	3130	65.75	14.75	39.25	23.25	207	25.5
	93HT-7215-40-G*	3678	71.75	14.75	39.25	23.25	220	28
	93HT-8415-40-G	4115	83.75	14.75	39.25	23.25	245	32.5
	93HT-9615-40-G	5970	95.5	14.75	39.25	23.25	297	38

ORDERING NOTES

Voice/Power/Data modules can be specified by placing a 'W' at the end of the hutch model number and applying a \$120 list upcharge. Hutches come standard with Krug panel grade 1 fabric. See page 6 for information.

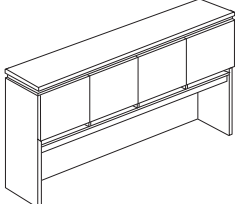
	93HTPM-6615-40	2990	65.75	14.75	39.25	20	233	25.5
	93HTPM-7215-40*	3513	71.75	14.75	39.25	20	251	28
	93HTPM-7815-40	3721	77.75	14.75	39.25	20	269	30
	93HTPM-8415-40	3930	83.75	14.75	39.25	20	287	32.5
	93HTPM-9615-40	5699	95.5	14.75	39.25	20	348	38

ORDERING NOTES

Voice/Power/Data modules can be specified by placing a 'W' at the end of the hutch model number and applying a \$120 list upcharge. Hutches come standard with Krug panel grade 1 fabric. See page 6 for information. 18" Paper Managers can only be used with this Paper Manager Hutch.

ORDERING PROCEDURE

To order, please specify the following:

- 1) Krug product model number
- 2) Wood species and finish, see page 4
- 3) Edge Profile, see page 13

*Indicates model illustrated by line drawing.

CODE DESCRIPTION

- G — wood framed frosted glass doors
- W — power/data/voice module

LOCKS

Locks are optional on all wood doors at an upcharge of \$100 list per set of (2) doors. Locks are not available on wood framed frosted glass doors.

HUTCHES

Hutches over 84" in length will be made in two pieces.

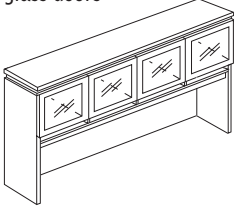
Description	Model	Maple Cherry	W	D	H	CH	Shipping Weight	Cubic Feet
	93HTPM-6615-40G	3349	65.75	14.75	39.25	20	233	25.5
	93HTPM-7215-40G*	3936	71.75	14.75	39.25	20	251	28
	93HTPM-7815-40G	4168	77.75	14.75	39.25	20	269	30
	93HTPM-8415-40G	4402	83.75	14.75	39.25	20	287	32.5
	93HTPM-9615-40G	6383	95.5	14.75	39.25	20	348	38

ORDERING NOTES

Voice/Power/Data modules can be specified by placing a 'W' at the end of the hutch model number and applying a \$120 list upcharge. Hutches come standard with Krug panel grade 1 fabric. See page 6 for information. 18" Paper Managers can only be used with this Paper Manager Hutch.

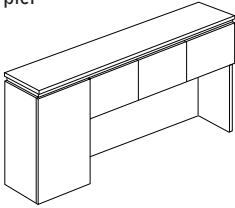
Description	Model	Maple Cherry	W	D	H	CH	Shipping Weight	Cubic Feet
	93HTPR-6615-40-L110HR0 L00HR11	3464	65.75	14.75	39.25	23.25	239	25.5
	93HTPR-7215-40-L110HR0* L00HR11	3940	71.75	14.75	39.25	23.25	255	28
	93HTPR-7815-40-L110HR0 L00HR11	4169	77.75	14.75	39.25	23.25	272	30
	93HTPR-8415-40-L110HR0 L00HR11	4408	83.75	14.75	39.25	23.25	289	32.5
	93HTPR-9615-40-L110HR0 L00HR11	6392	95.5	14.75	39.25	23.25	352	38

ORDERING NOTES

Voice/Power/Data modules can be specified by placing a 'W' at the end of the hutch model number and applying a \$120 list upcharge. Hutches come standard with Krug panel grade 1 fabric. See page 6 for information.

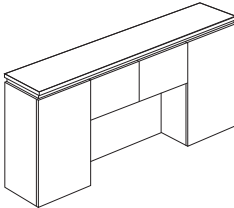
Description	Model	Maple Cherry	W	D	H	CH	Shipping Weight	Cubic Feet
	93HTPR-6615-40-L110HR11	3775	65.75	14.75	39.25	23.25	249	25.5
	93HTPR-7215-40-L110HR11*	4251	71.75	14.75	39.25	23.25	266	28
	93HTPR-7815-40-L110HR11	4502	77.75	14.75	39.25	23.25	282	30
	93HTPR-8415-40-L110HR11	4767	83.75	14.75	39.25	23.25	299	32.5
	93HTPR-9615-40-L110HR11	6912	95.5	14.75	39.25	23.25	352	38

ORDERING NOTES

Voice/Power/Data modules can be specified by placing a 'W' at the end of the hutch model number and applying a \$120 list upcharge. Hutches come standard with Krug panel grade 1 fabric. See page 6 for information.

DIMENSION KEY

- W — width
- D — depth
- H — height of unit
- CH — clearance height from worksurface

Dimensions are in inches and approximate. Contact Customer Service if dimensions are critical.

*Indicates model illustrated by line drawing.

CODE DESCRIPTION

- 11 — closed wood pier door
- G — wood framed frosted glass doors
- W — power/data/voice module

STANDARD FINISHES

For a complete list of standard wood finishes please see page 4.

KRUG EXPRESS

Only Krug panel fabrics are available on *KrugExpress*.

EFFECTIVE MARCH 1, 2008 A PRICE INCREASE OF 5% WILL APPLY TO ALL PRODUCTS IN THIS PRICE LIST

HUTCHES

EFFECTIVE MARCH 1, 2008 A PRICE INCREASE OF 5% WILL APPLY TO ALL PRODUCTS IN THIS PRICE LIST

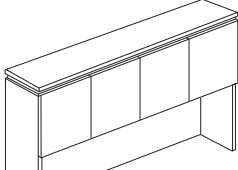
Description	Model	Maple	W	D	H	CH	Shipping Weight	Cubic Feet
		Cherry						
	93HT-4815-53	2428	47.75	14.75	52.5	23.25	220	26
	93HT-6015-53	2882	59.75	14.75	52.5	23.25	263	31
	93HT-6615-53	3494	65.75	14.75	52.5	23.25	285	34
	93HT-7215-53*	4105	71.75	14.75	52.5	23.25	307	37
	93HT-7815-53	4349	77.75	14.75	52.5	23.25	328	40
	93HT-8415-53	4593	83.75	14.75	52.5	23.25	350	43
	93HT-9615-53	6660	95.5	14.75	52.5	23.25	419	50.5

ORDERING NOTES

Voice/Power/Data modules can be specified by placing a 'W' at the end of the hutch model number and applying a \$120 list upcharge. Hutches come standard with Krug panel grade 1 fabric. See page 6 for information.

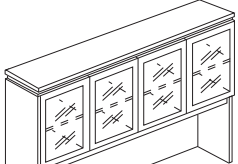
Description	Model	Maple	W	D	H	CH	Shipping Weight	Cubic Feet
		Cherry						
	93HT-4815-53G	2719	47.75	14.75	52.5	23.25	220	26
	93HT-6015-53G	3228	59.75	14.75	52.5	23.25	263	31
	93HT-6615-53G	3913	65.75	14.75	52.5	23.25	285	34
	93HT-7215-53G*	4597	71.75	14.75	52.5	23.25	307	37
	93HT-7815-53G	4871	77.75	14.75	52.5	23.25	328	40
	93HT-8415-53G	5145	83.75	14.75	52.5	23.25	350	43
	93HT-9615-53G	7460	95.5	14.75	52.5	23.25	419	50.5

ORDERING NOTES

Voice/Power/Data modules can be specified by placing a 'W' at the end of the hutch model number and applying a \$120 list upcharge. Hutches come standard with Krug panel grade 1 fabric. See page 6 for information.

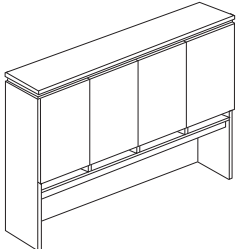
Description	Model	Maple	W	D	H	CH	Shipping Weight	Cubic Feet
		Cherry						
	93HTPM-6615-53	3738	65.75	14.75	52.5	20	301	34
	93HTPM-7215-53*	4392	71.75	14.75	52.5	20	325	37
	93HTPM-7815-53	4654	77.75	14.75	52.5	20	348	40
	93HTPM-8415-53	4914	83.75	14.75	52.5	20	371	43
	93HTPM-9615-53	7126	95.5	14.75	52.5	20	442	50.5

ORDERING NOTES

Voice/Power/Data modules can be specified by placing a 'W' at the end of the hutch model number and applying a \$120 list upcharge. Hutches come standard with Krug panel grade 1 fabric. See page 6 for information. 18" Paper Managers can only be used with this Paper Manager Hutch.

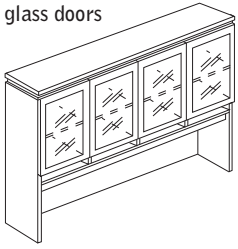
Description	Model	Maple	W	D	H	CH	Shipping Weight	Cubic Feet
		Cherry						
	93HTPM-6615-53G	4187	65.75	14.75	52.5	20	285	34
	93HTPM-7215-53G*	4918	71.75	14.75	52.5	20	307	37
	93HTPM-7815-53G	5212	77.75	14.75	52.5	20	328	40
	93HTPM-8415-53G	5503	83.75	14.75	52.5	20	350	43
	93HTPM-9615-53G	7980	95.5	14.75	52.5	20	419	50.5

ORDERING NOTES

Voice/Power/Data modules can be specified by placing a 'W' at the end of the hutch model number and applying a \$120 list upcharge. Hutches come standard with Krug panel grade 1 fabric. See page 6 for information. 18" Paper Managers can only be used with this Paper Manager Hutch.

ORDERING PROCEDURE

To order, please specify the following:

- 1) Krug product model number
- 2) Wood species and finish, see page 4
- 3) Edge Profile, see page 13

*Indicates model illustrated by line drawing.

CODE DESCRIPTION

- G — wood framed frosted glass doors
- W — power/data/voice module

LOCKS

Locks are optional on all wood doors at an upcharge of \$100 list per set of (2) doors. Locks are not available on wood framed frosted glass doors.

HUTCHES

Hutches over 84" in length will be made in two pieces.

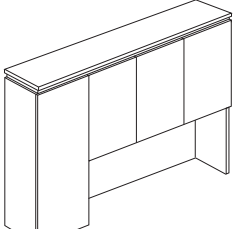
Description	Model	Maple Cherry	W	D	H	CH	Shipping Weight	Cubic Feet
 6-hi hutch single wood door pier	93HTPR-6615-53-L110HR0 L00HR11	4192	65.75	14.75	52.5	23.25	327	34
	93HTPR-7215-53-L110HR0* L00HR11	4925	71.75	14.75	52.5	23.25	350	37
	93HTPR-7815-53-L110HR0 L00HR11	5218	77.75	14.75	52.5	23.25	272	30
	93HTPR-8415-53-L110HR0 L00HR11	5512	83.75	14.75	52.5	23.25	397	43
	93HTPR-9615-53-L110HR0 L00HR11	7992	95.5	14.75	52.5	23.25	468	50.5

ORDERING NOTES

Voice/Power/Data modules can be specified by placing a 'W' at the end of the hutch model number and applying a \$120 list upcharge. Hutches come standard with Krug panel grade 1 fabric. See page 6 for information.

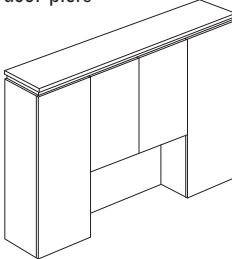
Description	Model	Maple Cherry	W	D	H	CH	Shipping Weight	Cubic Feet
 6-hi hutch left and right wood door piers	93HTPR-6615-53-L110HR11	4527	65.75	14.75	52.5	23.25	341	34
	93HTPR-7215-53-L110HR11*	5319	71.75	14.75	52.5	23.25	364	37
	93HTPR-7815-53-L110HR11	5636	77.75	14.75	52.5	23.25	399	40
	93HTPR-8415-53-L110HR11	5952	83.75	14.75	52.5	23.25	411	43
	93HTPR-9615-53-L110HR11	8631	95.5	14.75	52.5	23.25	482	50.5

ORDERING NOTES

Voice/Power/Data modules can be specified by placing a 'W' at the end of the hutch model number and applying a \$120 list upcharge. Hutches come standard with Krug panel grade 1 fabric. See page 6 for information.

DIMENSION KEY

- W — width
- D — depth
- H — height of worksurface
- CH — clearance height from worksurface

Dimensions are in inches and approximate. Contact Customer Service if dimensions are critical.

*Indicates model illustrated by line drawing.

CODE DESCRIPTION

- 11 — closed wood pier door
- W — power/data/voice module

STANDARD FINISHES

For a complete list of standard wood finishes please see page 4.

KRUG EXPRESS

Only Krug panel fabrics are available on *KrugExpress*.

EFFECTIVE MARCH 1, 2008 A PRICE INCREASE OF 5% WILL APPLY TO ALL PRODUCTS IN THIS PRICE LIST

TACKBOARD FOR HUTCHES

Tackboard upcharges for hutches

Use this chart to find the upcharge for tackboard fabrics graded 2–9 and add it to the cost of the hutch.

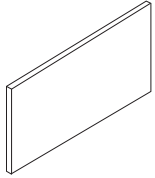

		FABRIC GRADES								
		2	3	4	5	6	7	8	9	com
66"	hutch tackboard	115	250	367	490	609	725	842	1045	2.25
72"	hutch tackboard	139	298	437	587	728	868	1008	1213	2.25
78"	hutch tackboard	164	350	516	737	848	1014	1180	1407	2.5
84"	hutch tackboard	195	406	603	797	993	1187	1381	1634	2.75
96"	hutch tackboard	241	501	419	983	1225	1467	1705	1978	3
66"	single pier door hutch tackboard	104	221	324	432	537	639	743	903	2
72"	single pier door hutch tackboard	104	221	324	432	537	639	743	903	2
78"	single pier door hutch tackboard	104	221	324	432	537	639	743	903	2.25
84"	single pier door hutch tackboard	115	250	367	490	609	725	842	1045	2.75
96"	single pier door hutch tackboard	195	406	603	797	993	1187	1381	1634	2.75
66"	double pier door hutch tackboard	104	221	324	432	537	639	743	903	1.25
72"	double pier door hutch tackboard	104	221	324	432	537	639	743	903	1.5
78"	double pier door hutch tackboard	104	221	324	432	537	639	743	903	1.75
84"	double pier door hutch tackboard	104	221	324	432	537	639	743	903	2
96"	double pier door hutch tackboard	115	250	367	490	609	725	842	1045	2.25

ORDERING NOTES

All hutches come standard with a Krug panel grade 1 fabric.

Only Krug panel fabrics are available on *KrugExpress*.

ORDERING PROCEDURE

To order, please specify the following:

- 1) Krug product model number
- 2) Wood species and finish, see page 4
- 3) Edge Profile, see page 13

*Indicates model illustrated by line drawing.

TACKBOARD YARDAGE

See page 19 for the COM yardage calculation chart for tackboards.

Description	Model	Maple Cherry	W	D	H	Shipping Weight	Cubic Feet
Paper manager with drawers 	93PM-171318-01	917	17	12.5	18	48	3
	93PM-171320-01*	954	17	12.5	19.75	50	3

ORDERING NOTES

20" Paper Manager cannot be used for Paper Manager Hutches. 18" Paper Managers are only used with Paper Manager Hutches. 18" Paper Managers only have 2 shelves.

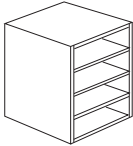
Paper manager horizontal 	93PM-171220-03	891	17	12	19.95	50	3
---	----------------	-----	----	----	-------	----	---

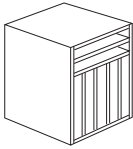
Paper manager vertical 	93PM-171220-02	891	17	12	19.75	50	3
--	----------------	-----	----	----	-------	----	---

DIMENSION KEY

W — width
D — depth
H — height of worksurface

Dimensions are in inches and approximate.
Contact Customer Service if dimensions are critical.

*Indicates model illustrated by line drawing.

CODE DESCRIPTION

PM — paper management



STANDARD FINISHES

For a complete list of standard wood finishes please see page 4.

EFFECTIVE MARCH 1, 2008 A PRICE INCREASE OF 5% WILL APPLY TO ALL PRODUCTS IN THIS PRICE LIST

PEDESTALS

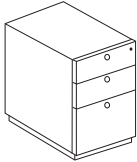
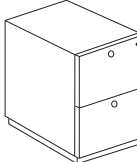
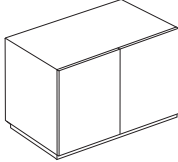
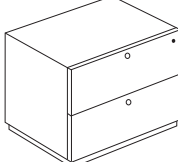
EFFECTIVE MARCH 1, 2008 A PRICE INCREASE OF 5% WILL APPLY TO ALL PRODUCTS IN THIS PRICE LIST

Description	Model	Maple Cherry	W	D	H	Shipping Weight	Cubic Feet
 2 box, 1 file pedestal	93P-1620-4F	1358	15.75	20	28	76	6.5
	93P-1624-4F*	1407	15.75	24	28	81	7.5
	93P-1630-4F	1455	15.75	30	28	100	9.5
 2 file pedestal	93P-1620-4D	1267	15.75	20	28	76	6.5
	93P-1624-4D*	1315	15.75	24	28	81	7.5
	93P-1630-4D	1364	15.75	30	28	100	9.5
 Bookcase pedestal	93PBC-3620*	1543	35.75	20	28	120	14
	93PBC-3624	1653	35.75	24	28	130	16.5
 Lateral file pedestal	93PLF-3020	1728	29.75	20	28	120	11.5
	93PLF-3620	1825	35.75	20	28	140	14
	93PLF-3024*	1854	29.75	24	28	130	14
	93PLF-3624	1958	35.75	24	28	150	16.5
 Mobile pedestal	93MP-1618284F	1443	15.5	20	27.75	75	7.5

ORDERING NOTES
Adjusted to fit under 20" Deep Cases.

ORDERING PROCEDURE

To order, please specify the following:

- 1) Krug product model number
- 2) Wood species and finish, see page 4
- 3) Edge Profile, see page 13

*Indicates model illustrated by line drawing.

CODE DESCRIPTION





- BC — bookcase
- D — 2 file drawers
- F — 2 box, 1 file drawer
- LF — lateral file
- MF — mobile pedestal

LOCKS

Locks are standard on all pedestals and lateral file drawers, with the exception of bookcase pedestals.

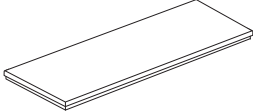
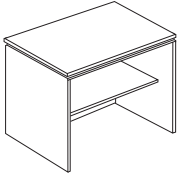
MODULAR PEDESTALS

Only 20" deep modular pedestals can be specified with return and credenza shells, please see pages 33 and 42.

Description	Model	Maple Cherry	W	D	H	Shipping Weight	Cubic Feet
Modular top 	93TP-4820	609	48	20	-	47	2.25
	93TP-4824	626	48	24	-	56	2.75
	93TP-5420	656	53.75	20	-	52	2.5
	93TP-5424	702	53.75	24	-	63	3
	93TP-6020	749	59.75	20	-	58	2.75
	93TP-6024	795	59.75	24	-	70	3.25
	93TP-6620	889	65.75	20	-	64	3
	93TP-6624	962	65.75	24	-	77	3.5
	93TP-7220	1035	71.75	20	-	67	3.25
	93TP-7224	1108	71.75	24	-	84	4
	93TP-7820	1181	77.75	20	-	76	3.5
	93TP-7824	1255	77.75	24	-	91	4.25
	93TP-8420	1328	83.75	20	-	81	3.75
	93TP-8424	1401	83.75	24	-	98	4.5
Computer stand 	93THC-362031*	1758	36	20	30.5	105	20
	93THC-362031-M	1803	36	20	30.5	105	20
	93THC-482031	1819	48	20	30.5	130	26
	93THC-482031-M	1862	48	20	30.5	130	26
Round meeting table 	9305-36	1317	36	-	1.75	50	3
	9305-42	1544	42	-	1.75	80	4
	9305-48	1679	48	-	1.75	80	5
	9305-60	1833	60	-	1.75	124	7.75
Drum base 	9310-18D29	470	48	18 dia	28.75	97	1.5
Half gable 	93HG-2029	209	19.75	-	27.25	18	1

DIMENSION KEY

W — width
D — depth
H — height of unit

Dimensions are in inches and approximate.
Contact Customer Service if dimensions are critical.

* Indicates model illustrated by line drawing.
**Indicates model illustrated by line drawing.

CODE DESCRIPTION

M — mobile

STANDARD FINISHES

For a complete list of standard wood finishes please see page 4.

OPEN SPANS

Modular units with an open span greater the 48" require the support of a half gable.

EFFECTIVE MARCH 1, 2008 A PRICE INCREASE OF 5% WILL APPLY TO ALL PRODUCTS IN THIS PRICE LIST

KEYBOARD | PENCIL DRAWERS | GROMMETS

EFFECTIVE MARCH 1, 2008 A PRICE INCREASE OF 5% WILL APPLY TO ALL PRODUCTS IN THIS PRICE LIST

Description	Model	Price	W	D	H	Shipping Weight	Cubic Feet
Keyboard tray with palm rest, mouse tray and extended articulating mechanism	93KBAMT-1912	438	27	11 to 29.5	1 to 10	20	2

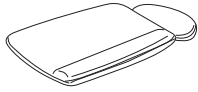

ORDERING NOTES

This unit comes with a lever-free arm keyboard support. This unit is granite in color. Order for 24" tops or deeper.

Pencil drawer	93PD-2116	386	21.5	16	1	2	1
---------------	-----------	-----	------	----	---	---	---

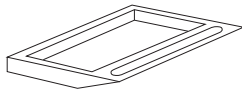

ORDERING NOTES

Pencil drawers are available in Maple or Cherry. Please specify finish on Purchase Order.

Power and telephone grommet	93PDSM	166	3	2		1	1
-----------------------------	--------	-----	---	---	--	---	---

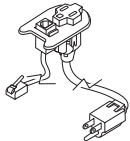

Pop-up power center	93PUPC*	220	4	2.5	8.5	1	1
	93PUPD**						

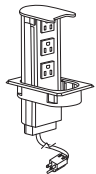

*

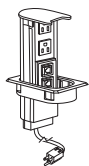

**

ORDERING NOTES

If ordering pop-up grommets for field installation, please note clearly on Purchase Order.

ORDERING PROCEDURE

To order, please specify the following:

- 1) Krug product model number
- 2) Wood species and finish, see page 4
- 3) Edge Profile, see page 13



*Indicates model illustrated by line drawing.

CODE DESCRIPTION

KBAMT — keyboard drawer with mouse tray
 PD — pencil drawer
 PDSM — power and telephone grommet
 PUPC — pop-up power center
 PUPD — pop-up power/data center

WIRING GROMMETS

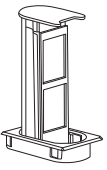
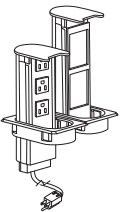
One rectangular grommet in a standard position is optional at no charge. Additional rectangular grommets are available at an upcharge of \$100 list. See pages 15 and 16 for more wiring grommet information.

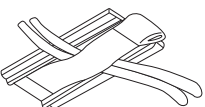
Description	Model	Price	W	D	H	Shipping Weight	Cubic Feet
Pop-up communication housing	93PUCH	109	4	2.5	8.5	1	1
	ORDERING NOTES If ordering pop-up grommets for field installation, please note clearly on Purchase Order.						
Pop-up power center and communication housing	93PUDG	294	4	5.25	8.5	1	1
	ORDERING NOTES If ordering pop-up grommets for field installation, please note clearly on Purchase Order.						
Wire management cover	93WM72	99	72	2.5	1	3	7
							
Velcro wire management	93WM4	29	3.5	1.75	-	1	1
							

DIMENSION KEY

- W — width
- D — depth
- H — height of worksurface

Dimensions are in inches and approximate.
Contact Customer Service if dimensions are critical.

*Indicates model illustrated by line drawing.

CODE DESCRIPTION

- PUCH — pop-up communication housing
- PUDG — pop-up center and communication housing
- WM — wire management



WIRING GROMMETS

One rectangular grommet in a standard position is optional at no charge. Additional rectangular grommets are available at an upcharge of \$100 list.

EFFECTIVE MARCH 1, 2008 A PRICE INCREASE OF 5% WILL APPLY TO ALL PRODUCTS IN THIS PRICE LIST

EFFECTIVE MARCH 1, 2008 A PRICE INCREASE OF 5% WILL APPLY TO ALL PRODUCTS IN THIS PRICE LIST

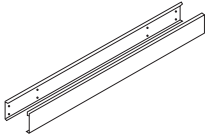
ACCESSORIES

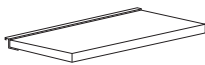
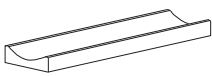
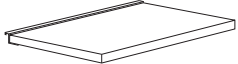
Description	Model	Maple Cherry	W	D	H	Shipping Weight	Cubic Feet
Tackboard organizer rail 	93A0B	87	-	-	2.5	-	-
ORDERING NOTES Please add suffix appropriate to unit ordered, for example: 93A0B84HT to be added to existing hutch or wall unit. Specify clearly on Purchase Order which products are to receive organizer rails and accessory options.							
Wood accessory bin 	93AWB-150504	359	1.75	7.5	0.75	1	0.25
Wood accessory shelf 	93AWS-150601	386	6	9.75	2.5	2	0.5
Wood pencil tray 	93AWPT-150501	386	12	10.75	2	2	0.5
Wood legal paper shelf 	93AWPS-151001	399	3.5	6.25	1.25	1	0.25

ORDERING PROCEDURE

To order, please specify the following:

- 1) Krug product model number
- 2) Wood species and finish, see page 4
- 3) Edge Profile, see page 13

*Indicates model illustrated by line drawing.

STANDARD FINISHES

For a complete list of standard wood finishes please see page 4.

KRUG EXPRESS

Wood accessories are not available on *KrugExpress*.

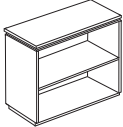
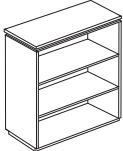
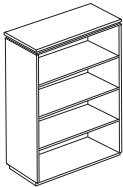
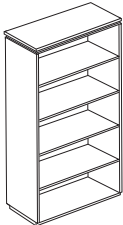
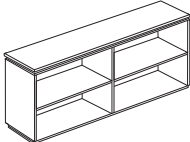
Description	Model	Maple Cherry	W	D	H	Shipping Weight	Cubic Feet
2-hi open bookcase 	93BC-3016-31	1325	30	15.75	30.5	90	10
	93BC-3616-31	1360	36	15.75	30.5	100	12
3-hi open bookcase 	93BC-3016-44	1506	30	15.75	41.5	110	14.5
	93BC-3616-44	1536	36	15.75	41.5	120	17
4-hi open bookcase 	93BC-3016-57	1689	30	15.75	55	130	19
	93BC-3616-57	1726	36	15.75	55	140	22
5-hi open bookcase 	93BC-3016-70	1831	30	15.75	69.5	150	22.5
	93BC-3616-70	1872	36	15.75	69.5	160	27
2-hi double bookcase 	93BC-7216-31	1788	71.75	15.75	29.5	180	23.5

DIMENSION KEY

W — width
D — depth
H — height of unit

Dimensions are in inches and approximate.
Contact Customer Service if dimensions are critical.

*Indicates model illustrated by line drawing.

CODE DESCRIPTION

BC — bookcase

STANDARD FINISHES

For a complete list of standard wood finishes please see page 4.

BOOKCASES

Bookcases do not have finished backs. 5-hi bookcases require fastening to a wall for safety.

EFFECTIVE MARCH 1, 2008 A PRICE INCREASE OF 5% WILL APPLY TO ALL PRODUCTS IN THIS PRICE LIST

BOOKCASES | STORAGE

EFFECTIVE MARCH 1, 2008 A PRICE INCREASE OF 5% WILL APPLY TO ALL PRODUCTS IN THIS PRICE LIST

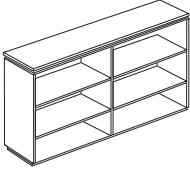
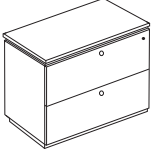
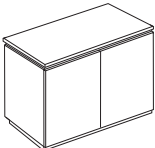
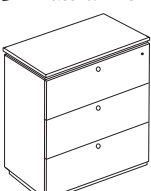
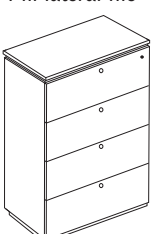
Description	Model	Maple Cherry	W	D	H	Shipping Weight	Cubic Feet
3-hi double bookcase 	93BC-7216-44	1937	71.75	15.75	41.5	225	33
2-hi lateral file 	93ST-302031-01	2374	30	20	30.5	160	12
	93ST-302431-01*	2405	30	24	30.5	170	14.5
	93ST-362031-01	2462	36	20	30.5	170	14.5
	93ST-362431-01	2497	36	24	30.5	180	17
2-hi closed bookcase 	93ST-362031-11	1875	36	20	30.5	140	14.5
	93ST-362431-11*	1907	36	24	30.5	150	17
3-hi lateral file 	93ST-362044-01	3101	36	20	41.5	204	20
	93ST-362444-01*	3165	36	24	41.5	226	24
4-hi lateral file 	93ST-362057-01	3600	30	20	55	250	26
	93ST-362457-01*	3677	36	24	55	275	31

ORDERING PROCEDURE

To order, please specify the following:

- 1) Krug product model number
- 2) Wood species and finish, see page 4
- 3) Edge Profile, see page 13

*Indicates model illustrated by line drawing.

CODE DESCRIPTION

BC — bookcase
ST — storage unit

LOCKS

Locks are standard on all pedestals and lateral file drawers, with the exception of bookcase pedestals.

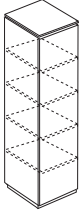
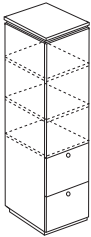
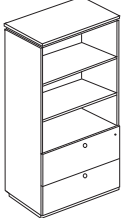
Description	Model	Maple Cherry	W	D	H	Shipping Weight	Cubic Feet
5-hi closed shelves 	93ST-192070-11L	2322	18.75	20	69.5	140	15
	93ST-192470-11L* R	2370	18.75	24	69.5	160	18
5-hi storage 2 file, 3 closed 	93ST-192070-91L	2634	18.75	20	69.5	196	17.5
	93ST-192470-91L* R	2894	18.75	24	69.5	221	21
5-hi 2 lateral file, 3 open shelves 	93ST-362070-03	3688	36	20	69.5	250	32
	93ST-362470-03*	3737	35.75	23.75	69.5	260	38

DIMENSION KEY

W — width
D — depth
H — height of unit

Dimensions are in inches and approximate.
Contact Customer Service if dimensions are critical.

*Indicates model illustrated by line drawing.

CODE DESCRIPTION

ST — storage unit
L — door hinged left
R — door hinged right



STANDARD FINISHES

For a complete list of standard wood finishes please see page 4.

EFFECTIVE MARCH 1, 2008 A PRICE INCREASE OF 5% WILL APPLY TO ALL PRODUCTS IN THIS PRICE LIST

STORAGE

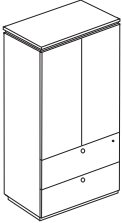
EFFECTIVE MARCH 1, 2008 A PRICE INCREASE OF 5% WILL APPLY TO ALL PRODUCTS IN THIS PRICE LIST

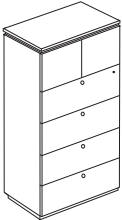
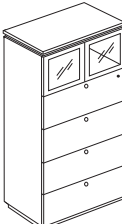
Description	Model	Maple Cherry	W	D	H	Shipping Weight	Cubic Feet
5-hi 2 lateral file, 3 closed wood doors	93ST-362070-04	4119	36	20	69.5	305	32
	93ST-362470-04*	4168	36	24	69.5	397	38
							
5-hi 2 lateral file, 3 closed glass doors	93ST-362070-04G	4426	36	20	69.5	305	32
	93ST-362470-04G*	4475	36	20	69.5	397	38
							
5-hi 4 lateral file, hinged wood door	93ST-362070-07	4313	36	20	69.5	335	32
	93ST-362470-07*	4448	36	24	69.5	427	38
							
5-hi 4 lateral file, hinged glass door	93ST-362070-07G	4571	36	20	69.5	335	32
	93ST-362470-07G*	4714	36	24	69.5	427	38
							
<p>ORDERING NOTES This item is <u>not</u> available on <i>KrugExpress</i>.</p>							

ORDERING PROCEDURE

To order, please specify the following:

- 1) Krug product model number
- 2) Wood species and finish, see page 4
- 3) Edge Profile, see page 13

*Indicates model illustrated by line drawing.

CODE DESCRIPTION

- ST — storage unit
- G — wood framed frosted glass doors

LOCKS

Locks are optional on all wood doors at an upcharge of \$100 list per set of (2) doors. Locks are not available on wood framed frosted glass doors.

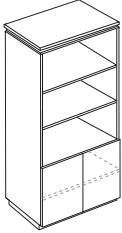
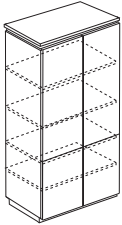
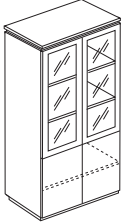
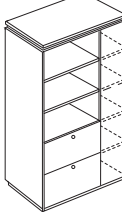
Description	Model	Maple Cherry	W	D	H	Shipping Weight	Cubic Feet
5-hi 2 closed, 3 open shelves 	93ST-362070-13	3123	36	20	69.5	250	32
	93ST-362470-13*	3169	36	24	69.5	270	38
5-hi 2 closed, 3 closed wood doors 	93ST-362070-14	3408	36	20	69.5	275	32
	93ST-362470-14*	3452	36	24	69.5	275	38
5-hi 2 closed, 3 closed glass doors 	93ST-362070-14G	3647	36	20	68.5	275	32
	93ST-362470-14G*	3700	36	24	69.5	286	38
5-hi storage, 5 closed 2 files, 3 open shelves 	93ST-302070-123	3737	29.75	20	69.5	265	26.5
	93ST-302470-123* 124	3784	29.75	24	69.5	305	32

ORDERING NOTES

(123) Indicates open left shelves, closed right, 2 file drawers.
 (124) Indicates open right shelves, closed left, 2 file drawers.

DIMENSION KEY

W — width
 D — depth
 H — height of unit

Dimensions are in inches and approximate.
 Contact Customer Service if dimensions are critical.

*Indicates model illustrated by line drawing.

CODE DESCRIPTION

ST — storage unit
 G — wood framed frosted glass doors

STANDARD FINISHES

For a complete list of standard wood finishes please see page 4.

LOCKS

Locks are optional on all wood doors at an upcharge of \$100 list per set of (2) doors. Locks are not available on wood framed frosted glass doors.

EFFECTIVE MARCH 1, 2008 A PRICE INCREASE OF 5% WILL APPLY TO ALL PRODUCTS IN THIS PRICE LIST

STORAGE

EFFECTIVE MARCH 1, 2008 A PRICE INCREASE OF 5% WILL APPLY TO ALL PRODUCTS IN THIS PRICE LIST

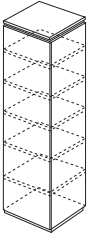
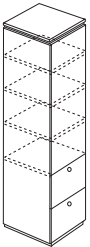
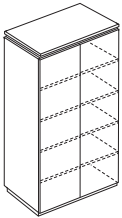
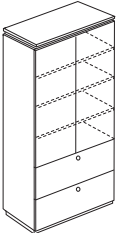
Description	Model	Maple Cherry	W	D	H	Shipping Weight	Cubic Feet
6-hi storage 	93ST-192083-11L R	2645	18.75	20	83	192	20.5
	93ST-192483-11L* R	2755	18.75	24	83	221	24
6-hi storage 2 files, 4 closed 	93ST-192083-91L R	2861	18.75	20	83	209	20.5
	93ST-192483-91L* R	2940	18.75	24	83	237	24
6-hi storage closed 	93ST-302083-11	3975	29.75	20	83	273	31.5
	93ST-302483-11*	4031	29.75	24	83	312	37.5
	93ST-362083-11	4128	35.75	20	83	317	37.5
	93ST-362483-11	4204	35.75	24	83	362	45
6-hi storage, 2 lateral, 4 closed 	93ST-302083-04	4266	29.75	20	83	302	31.5
	93ST-302483-04*	4325	29.75	24	83	339	37.5
	93ST-362083-04	4349	35.75	20	83	344	37.5
	93ST-362483-04	4373	35.75	24	83	386	45

ORDERING PROCEDURE

To order, please specify the following:

- 1) Krug product model number
- 2) Wood species and finish, see page 4
- 3) Edge Profile, see page 13

*Indicates model illustrated by line drawing.

CODE DESCRIPTION

- ST — storage unit
- L — door hinged left
- R — door hinged right

STANDARD FINISHES

For a complete list of standard wood finishes please see page 4.

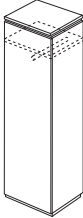
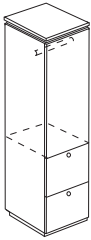
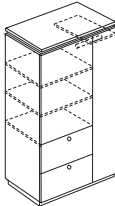
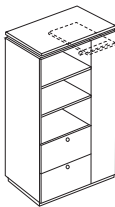
Description	Model	Maple Cherry	W	D	H	Shipping Weight	Cubic Feet
5-hi wardrobe 	93WR-192470-02L* R	2041	18.75	24	69.5	171	21
5-hi wardrobe, 2 file 	93WR-192470-22L* R	2862	18.75	24	69.5	201	21
5-hi wardrobe 2 file, 3 closed 	93WR-302470-14* 15	3741	29.75	24	69.5	295	32
ORDERING NOTES (14) Indicates closed left shelves, closed right wardrobe, 2 file drawers. (15) Indicates closed right shelves, closed left wardrobe, 2 file drawers. Closed shelves are center hinged.							
5-hi wardrobe with 2 file, 3 open 	93WR-302470-27* 28	3668	29.75	24	69.5	305	32
ORDERING NOTES (27) Indicates open left shelves, closed right wardrobe, 2 file drawers. (28) Indicates open right shelves, closed left wardrobe, 2 file drawers.							

DIMENSION KEY

- W — width
- D — depth
- H — height of worksurface
- KW — kneehole width

Dimensions are in inches and approximate.
Contact Customer Service if dimensions are critical.

*Indicates model illustrated by line drawing.

CODE DESCRIPTION

- WR — wardrobe
- L — door hinged left
- R — door hinged right

LOCKS

Locks are optional on all wood doors at an upcharge of \$100 list per set of (2) doors.

WARDROBES

EFFECTIVE MARCH 1, 2008 A PRICE INCREASE OF 5% WILL APPLY TO ALL PRODUCTS IN THIS PRICE LIST

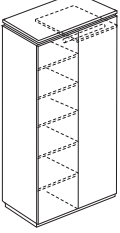
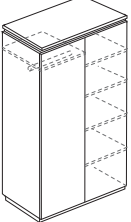
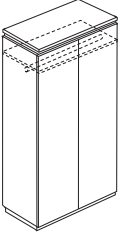
Description	Model	Maple Cherry	W	D	H	Shipping Weight	Cubic Feet
5-hi wardrobe 5 closed shelves	93WR-302470-18* 19	3089	29.75	20	69.5	298	32
	ORDERING NOTES (18) Indicates left shelves and right wardrobe. (19) Indicates right shelves and left wardrobe. Closed shelves are center hinged.						
5-hi wardrobe 5 closed	93WR-302470-01 03	3089	29.75	24	69.5	282	31.5
	93WR-362470-01 03*	3249	35.75	24	69.5	327	40
ORDERING NOTES (01) Indicates left shelves and right wardrobe. (03) Indicates right shelves and left wardrobe.							
5-hi full width wardrobe	93WR-362470-02	2452	36	24	69.5	272	38
							

ORDERING PROCEDURE

To order, please specify the following:

- 1) Krug product model number
- 2) Wood species and finish, see page 4
- 3) Edge Profile, see page 13

*Indicates model illustrated by line drawing.

CODE DESCRIPTION

WR — wardrobe

STANDARD FINISHES

For a complete list of standard wood finishes please see page 4.

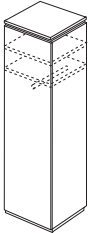
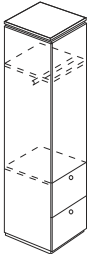
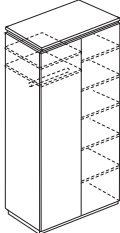
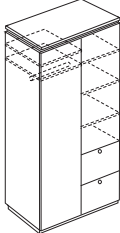
Description	Model	Maple Cherry	W	D	H	Shipping Weight	Cubic Feet
6-hi wardrobe, 2 shelves 	93WR-192483-02L R	3052	18.75	24	83	198	24
6-hi wardrobe, 2 files, 4 closed 	93WR-192483-22L* R	3280	18.75	24	83	222	24
6-hi wardrobe, 6 closed 	93WR-302483-01 03*	3322	29.75	24	83	319	37.5
	93WR-362483-01 03	3481	35.75	24	83	364	45
ORDERING NOTES (01) Indicates left shelves and right wardrobe. (03) Indicates right shelves and left wardrobe.							
6-hi wardrobe 2 files, 4 closed shelves 	93WR-302483-14 15*	4302	29.75	24	83	345	37.5
ORDERING NOTES (14) Indicates closed left shelves, closed right wardrobe, 2 file drawers. (15) Indicates closed right shelves, closed left wardrobe, 2 file drawers. Closed shelves are center hinged.							

DIMENSION KEY

W — width
D — depth
H — height of unit

Dimensions are in inches and approximate.
Contact Customer Service if dimensions are critical.

*Indicates model illustrated by line drawing.

CODE DESCRIPTION

WR — wardrobe
L — door hinged left
R — door hinged right

LOCKS

Locks are optional on all wood doors at an upcharge of \$100 list per set of (2) doors.

WARDROBES | AV CABINETS

EFFECTIVE MARCH 1, 2008 A PRICE INCREASE OF 5% WILL APPLY TO ALL PRODUCTS IN THIS PRICE LIST

Description	Model	Maple Cherry	W	D	H	Shipping Weight	Cubic Feet
6-hi wardrobe 6 closed shelves	93WR-302483-18 19*	3322	29.75	24	83	322	37.5

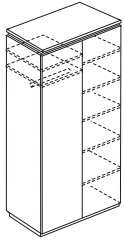

ORDERING NOTES

(18) Indicates closed left shelves, closed right wardrobe.
 (19) Indicates closed right shelves, closed left wardrobe.
 Closed shelves are center hinged.

AV cabinet	93AV-362470-02	4393	36	24	69.5	395	38
------------	----------------	------	----	----	------	-----	----

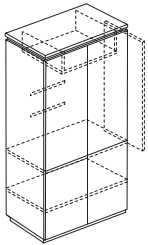

ORDERING NOTES

This item is not available on *KrugExpress*.

ORDERING PROCEDURE

To order, please specify the following:

- 1) Krug product model number
- 2) Wood species and finish, see page 4
- 3) Edge Profile, see page 13

*Indicates model illustrated by line drawing.

CODE DESCRIPTION

WR — wardrobe
 AV — audio visual cabinet

STANDARD FINISHES

For a complete list of standard wood finishes please see page 4.

CONTOUR

Product Specification Guide

72	General Product Specifications
73	Edge Detail Profiles
74	Bookcases, Grain Direction, Pulls & Locks
75	Grommets
77	Laminate Worksurfaces
78	Credenzas, Linking Units & Corner Units
79	Hutches, Overheads, Tackboards & Tasklights
80	Filing Instructions
81	Installation
83	Suggested Configurations

Product List

85	Desks
88	Curvilinear Desks
92	Returns
98	Curvilinear Returns
101	Linking Units
102	Corner Units
103	Credenzas
111	Overheads
112	Hutches
115	Paper Managers
115	Modular Pedestals
117	Keyboards, Pencil Drawers & Wiring Grommets
119	Bookcases, Storage & Wardrobes
125	Modular Components

EFFECTIVE MARCH 1, 2008 A PRICE INCREASE OF 5% WILL APPLY TO ALL PRODUCTS IN THIS PRICE LIST

GENERAL PRODUCT SPECIFICATIONS

Worksurfaces

Tops are 1 5/16" thick veneered particle board core. Desks have profiled edges front and back and flat side panels. Credenzas, returns, and link units have profiled front edges only, side and back edges are flat.

Modesty Panels

Modesty panels are standard on all desks, and optional on returns, link units, credenzas, as well as on curvilinear tops with wood post legs. Modesty panels are not available in conjunction with curvilinear tops that have metal post legs. Desks, credenzas, and curvilinear top modesty panels are 3/4" thick, and link unit modesty panels are 1 1/8" thick. Optional wire management cut-outs are available on credenzas, returns, and link units.

Veneer

External face veneers are Rift Oak, Cherry or Maple bookmatched veneer.

Finish

A five step catalyzed varnish finish that when dry has a sheen value of 32°, is applied to all finished cases.

Locks

Locks are standard on all pedestals and storage unit lateral file drawers. Locks are optional on door fronts and must be specified at time of order.

Drawers

Drawer slides have ball bearing movement with positive outstep and hold in catch. File drawers and box drawers have a load bearing capacity of 90 lbs. Drawer interiors have Birch veneer sides with matching bottoms. File drawers are available 15" for letter filing and 18" for legal filing. All box/box/file pedestals in desks, corner credenzas and modular pedestals are supplied with matching pencil tray.

Glides

Adjustable glides are 1 1/4" long and allow for a range of adjustment of 3/4". Glide inserts are installed at factory, glides need to be field installed.

Hinges

Hinges on all hutch, overhead and bookcase doors are European style with a 95° opening. All hinges are fully adjustable.

Pulls

Two types of pulls are available; Elliptical Pull with Matte Black finish and the Sweep Pull with Satin Nickel, Polished Chrome and Matte Black finish. Also available is a brushed brass traditional Westminster Pull with the traditional profile. Pulls are supplied on all drawers.

Testing Information

Contour meets or exceeds the testing requirements of ANSI / BIFMA X5.5-1998.



EDGE DETAIL PROFILES



Profiles do not appear on all edges of all products, please refer to this summary for locations.

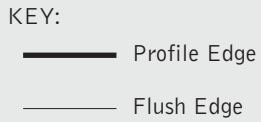

Desks

Desks have profiles on front and back edges, ends are flat.
Plan view of a desk shown left.



Credenzas

Credenzas have profile on the user's side, ends and back are flat.
Plan view of a credenza shown left.



Curvilinear Desks

Curvilinear desks have profile around the curved section, and a flat end above the end panel.
Plan view of bullet top and P top shown left.



Returns, and Link Units

Returns and link units have profile on the front edge and are flat on the back edge.
Profiles have coved edges on connecting ends of returns and link units, except "Berkshire" profile.
Plan view of a return and link unit shown left.



Plan view of a corner credenza shown left.

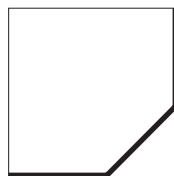

Corner Units

Corner units have profile on three sides, all other sides are flat.
Plan view of a corner unit shown left.

EFFECTIVE MARCH 1, 2008 A PRICE INCREASE OF 5% WILL APPLY TO ALL PRODUCTS IN THIS PRICE LIST

BOOKCASE | GRAIN DIRECTION | PULLS | LOCKS



Bookcase and Storage Units

Bookcase and storage units have profile on the front edge only.

Drawing of 29" high bookcase shown left.

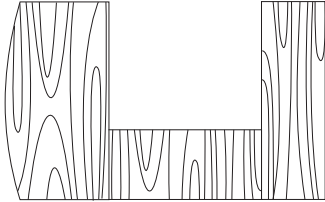

Grain Direction

Contour products are designed such that the grain direction is as shown in the diagram to the left.



Pulls

Pulls are located on all drawer fronts, wood storage doors, and wood bookcase doors.

The Elliptical pull is available in Matte Black only.



The Sweep pull is available in Matte Black, Satin Nickel, and Polished Chrome.

Pull color must be mentioned clearly in the purchase order.

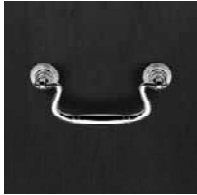

A Westminster pull in an antiqued brass finish is standard on all products specified with the Westminster edge detail.

Locks

Locks are provided as standard features on all pedestals, except bookcase pedestals, including those in desks, credenzas and lateral file storage units. Lock plugs on desks are located in the kneespace on the pedestal side panel.

Locks are available on the bookcase doors at an upcharge of \$100 list per set of (2) doors, please specify at time of order.

Lock plugs for bookcase doors are generally located on the top inside corner of door front.

Lock plugs for hutch and overhead doors are generally located on the lower inside corners.

Suites can be keyed alike at no upcharge, please specify on your purchase order.

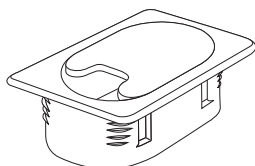

Grommets

All cases may be specified with one grommet in a standard position at no upcharge. A \$100 list upcharge will apply to additional grommets in standard positions and for grommets requested in non-standard positions a \$250 list upcharge will apply.

The grommet position must be indicated for each case on the order.

Standard Grommet

Black, rectangular, 4 1/8" x 2 11/16".

Grommets can also be field installed with a power drill, a 2 1/4" hole saw and a rasp or saber saw. Template for drilling is available.

Please keep in mind the location of grommets when specifying paper managers for use with worksurfaces. For example, a paper manager on the left hand side may be used with a "C", "BR" or "AR" grommet.

Standard Grommet Positions

Desks

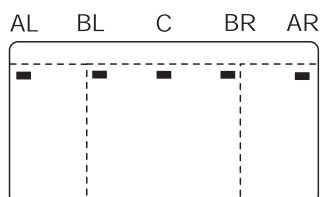

36" deep Desks:

Position Code:

- AL – left corner
- BL – left end beside pedestal gable
- C – center
- BR – right end beside pedestal gable
- AR – right corner



Curvilinear Tops

Position Code:

- C – center

This key applies to all bullet and P-shaped tops

The support panel is notched out to accommodate wire management.



GROMMETS

EFFECTIVE MARCH 1, 2008 A PRICE INCREASE OF 5% WILL APPLY TO ALL PRODUCTS IN THIS PRICE LIST

Grommets

Power and Communication Grommets

As companions to the standard grommets, the Contour product line incorporates various power and communication options. These items provide easy worksurface access for power, phone or data connections. Wire management raceways are also available for below surface mounting. All components must be specified for quantity and location. Refer to page 117 for pricing information.

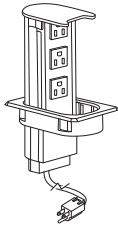

Pop-Up Power Center (97PUPC)

Power Center Details:	Dimensions:
three Simplex outlets	4 1/8" x 2 11/16"
10 ft. 15 Amp power cord	5 1/8" above worksurface
10 Amp circuit breaker	8 1/2" overall depth

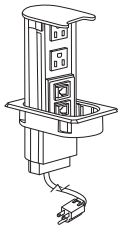

Pop-Up Power Center (97PUPD)

Power Center Details:	Communication Details:	Dimensions:
two Simplex outlets	one RJ11 phone coupler	4 1/8" x 2 11/16"
10 ft. 15 Amp power cord	one RJ45 data coupler	5 1/8" above worksurface
10 Amp circuit breaker		8 1/2" overall depth

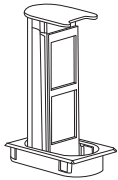

Pop-Up Communication Housing (97PUCH)

Supplied with adapters for RJ11 or RJ45 couplers.

Dimensions:
4 1/8" x 2 11/16"
7 1/2" above worksurface
8 1/2" overall depth

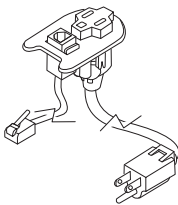

Power and Telephone Grommet (97PDSM)

Black, rectangular surface mount power and communication grommet.

Power details:	Communication Details:	Dimensions:
one Simplex outlet	one RJ11 phone line coupler	4 1/8" x 2 11/16"
15 Amp, 6 ft. cord	6 ft. cord	



Power / Data / Voice Module (supplied with wired hutches)

Black, rectangular with flip down cover. Includes two power outlets, one voice port, and one data port.

Power Details:	Communication Details:
two Simplex outlets	one 6-pin and one 8-pin connector
15 Amp, 10 ft. cord	

LAMINATE WORKSURFACES

EFFECTIVE MARCH 1, 2008 A PRICE INCREASE OF 5% WILL APPLY TO ALL PRODUCTS IN THIS PRICE LIST

Laminate Worksurfaces

Laminate worksurfaces are available for the Contour product line at no upcharge. Please see page 5 for complete laminate information. An upcharge may apply to specially priced plastic laminates.

Where there are wood profile edges on worksurface tops, they will remain as wood profiles on laminate tops. Where there are flush edges, as in the backs of link units, there will be laminate self edges. Please reference the illustration at the bottom of this page.

Krug will order and procure laminates. Purchase orders with a plastic laminate option must include:

- Manufacturer's Name
- Laminate Name
- Laminate Number

When specifying laminate worksurfaces, the grain direction is such that the grain pattern runs the length of each surface, as shown in the diagram below.

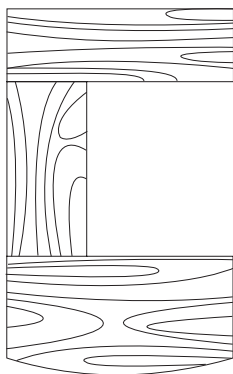

The grain direction exhibited above is different than the direction of the grain on veneered worksurfaces. Please contact Krug Customer Service for questions pertaining to laminate grain direction.

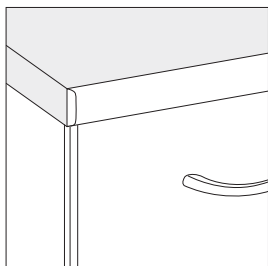

The diagram above illustrates the placement of laminate on Krug worksurfaces. The shaded areas represent laminate, while the non-shaded area indicates the profiled wood edge.

CREDENZAS

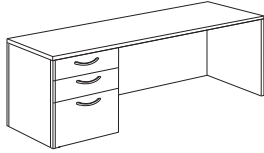

Credenzas

Contour offers a wide variety of credenzas for use as stand alone storage pieces, part of a connected worksurface configuration, or behind a desk. Choose from single or double pedestal options, with or without fixed or hinged modesty panels.

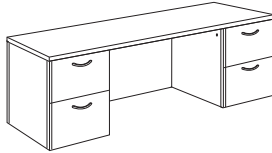

Modesty Panels

Credenzas without modesty panels provide easy access to wall mounted electrical sources without wiring difficulties, and are also a satisfying solution for the cost-minded customer.

Credenzas with modesty panels have an added finished look, and all cases are available with a wiring grommet in a standard position for added cable management, please specify on your order. Wiring grommets cannot be specified above the pedestal location.

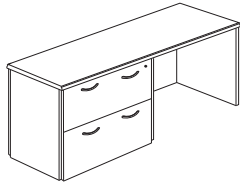

Pedestals

Contour credenzas are available with single, lateral file or bookcase pedestals.

LINKING UNITS & CORNER UNITS

Contour linking units and corner units are available in a range of sizes for ease of use in configuring a connected worksurface.

Linking units have coved ends, with grain direction running front to back.

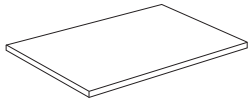

Linking Units

Linking units are for use between desks and credenzas in creating a U-shaped configuration, and must be supported at both ends. They are available with or without modesty panels.

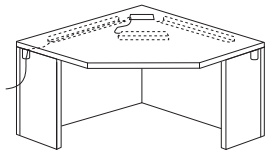

Corner Units

A corner unit can also be used on a U-shaped configuration, or it can be an integral part of a L-shaped work area with returns linked to either side.

Corner units have a standard grommet included in the back corner for ease of cable management, and have additional wire management access grommets in the half gables so that cable can be run to other areas of the connected worksurface. This can be assisted by a cut length of wire management cover.

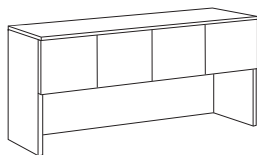

Hutches & Overheads

Contour offers hutch and overhead options for use in a work area configuration.

All hutches and overheads include tasklights that are factory installed and require no field adjustment. Tasklights are mounted beneath the cabinet and hidden from view.

Selected hutches and overheads are available with wood framed frosted glass doors.

Doors

Doors are equipped with fully adjustable European style hinges.

Locks are optional and can be specified at time of order for an upcharge of \$100 per set of (2) doors. If an uneven amount of doors require locks, the lock on the single door is also \$100. Locks are not available on glass doors.

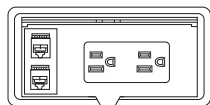

Hutch Power / Data / Voice Module

Access to power and data is made simple by using a hutch with a power/data/voice module built right into the tackboard. The module is fully installed at the factory but can be removed to connect data links on site. It features a flip door that retracts into the case of the unit when open.

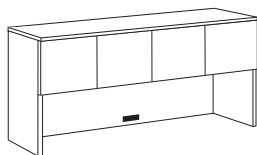

Tackboards

A tackboard in Krug panel grade 1 fabric is included with every hutch. Upcharges for higher graded fabrics are listed on page 114. Please note, not all fabrics are suitable for tackboard application. Tackboard fabric selections should be supplied with the order information. Fabric options are listed on page 6 of this price guide.

Tackboards are not included with overheads and must be ordered separately, see page 111 for pricing. Overhead tackboards include wall mounting hardware and instructions. Tackboards for hutches are installed at the factory and require no additional set up on site.

Only hutches and overhead tackboards in Krug panel fabrics are available on *KrugExpress*.

TASKLIGHTS & INSTALLATION

Tasklights

Tasklights are included with hutches and overheads and are installed before shipment. On hutches, the tasklight cord is threaded behind the hutch through a standard access grommet on the upper right hand side of the back panel.

Tasklights are installed on the underside of overhead units. Cords run down the right hand side of the tasklight to the worksurface where they can be routed behind the worksurface top. The use of a wall mounted Overhead tackboard conceals the cord from view.

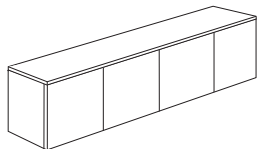

Installation

Hutch and overhead installation instructions are included with every case or can be found in this guide on pages 81-82. All mounting hardware required is included with the product.

FILING INSTRUCTIONS

Drawers will be offered for letter and legal size filing.
All units are equipped with file bars that are fixed in place for shipping.

Desk Pedestal File Drawers

Filing Capacity:

15" drawers
21" of letter filing front to back, or
12" of legal filing side to side
15" pedestal drawer depths allow only one row of side to side files.

18" drawers
21" of legal filing front to back
15" of legal filing side to side, one row and 15" of letter filing from side to side,
one row and 9" of legal filing front to back.

Weight capacity of pedestal file drawers is 90 lbs.

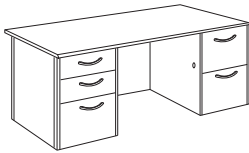

Credenza and Return Pedestal File Drawers

Filing Capacity:

15" drawers
15" of letter filing front to back, or
12" of legal filing side to side
15" pedestal drawer depths allow only one row of side to side files.

18" drawers
15" of legal filing front to back
15" of legal filing side to side
15" of letter size filing side to side, one row and 3" of legal filing front to back

Weight capacity of pedestal file drawers is 90 lbs.

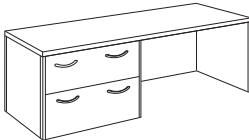
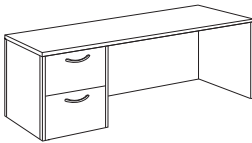

Credenza, Return or Storage Lateral File Drawers

Filing Capacity:

30" wide drawers:
30" letter filing front to back, or
25" legal filing side to side, or
15" of legal filing front to back.

When filing front to back, 30" lateral file drawer widths allow two rows of letter filing, but only one row of legal file width.

Filing Capacity:

36" wide drawers:
30" letter filing front to back, or
36" legal filing side to side, or
30" legal filing front to back.

Weight capacity of lateral file drawers is 135 lbs.

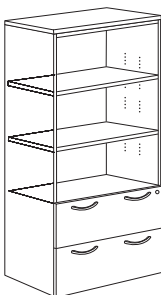
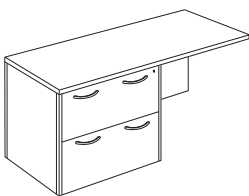

Linking Units, Tops and Returns

It is important that the main units (desk, credenza) to which the linking unit or return is being attached be in their final position and leveled.

Units are connected with mending plates under worksurface and wood screws on modesty and end panels. Locate connections and attach the mending plate under the worksurface. Level pieces if necessary by adjusting the glides to achieve flush and firm joints before completing installation of hardware.

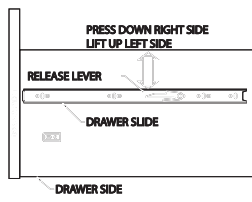

Drawer Removal

Pull drawer and slide out to the full extension position. With index finger, lift up the release lever on left side and press down the release lever on right side of the drawer (as shown). Make sure that you do this to each side at the same time.

Pull out the drawer with the attached drawer channel from the cabinet member.

To re-assemble, insert the drawer through the guide of the stop bumper.

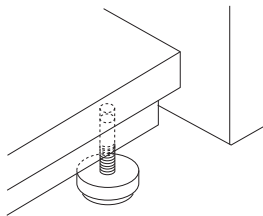

Glide Adjustment

Raise one corner of the unit at a time and adjust the glide to the desired height by turning the glide in the hole. Make sure unit is level after adjusting the glides.

Please note that the maximum adjustment range of the glides is 3/4".

When moving units after glides have been inserted, dial the glides to the lowest position to prevent damage.

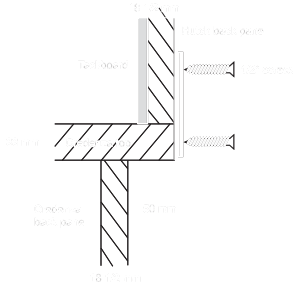

Hutch Installation

Before installing the hutch, insure that the worksurface has been placed in the final position and leveled. The worksurface should then be moved out a sufficient distance to allow access to the back. It is recommended that the minimum amount of movement be used with the leveling glides extended to prevent damage to the glides.

The hutch comes with self-adhesive foam strips that must be applied to the bottom edge prior to placing the hutch on the credenza. The foam is best applied with the hutch lying on its back. Do not leave any gaps in the foam strip, in order to prevent scratches to the credenza top while placing the hutch.

Place the hutch securely on the worksurface. Try to minimize any movement of the hutch to prevent scratching. Use of a blanket on the front portion of the credenza is recommended.

INSTALLATION

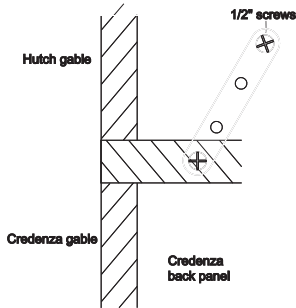

Hutch Installation (continued)

Using the supplied hardware, screw the flat bracket to the credenza back panel at each end, using the 3/4" screws provided. Swing the bracket up to approximately 60° and screw through the bracket into the hutch back with the 1/2" screws. Tighten all screws. Move combined hutch and credenza back to final location. Check for level again and adjust as required.

Please note that hutches are shipped with tackboards and task lights already installed.

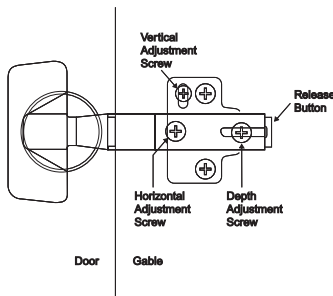

Door Adjustments

Hinges on all bookcase, overhead and hutch doors are designed to be adjusted for depth, horizontal and vertical alignment. This is easily done by adjusting the appropriate screw. See drawing.

To remove a door, push the release button and pull out the door, disconnecting the hinges.

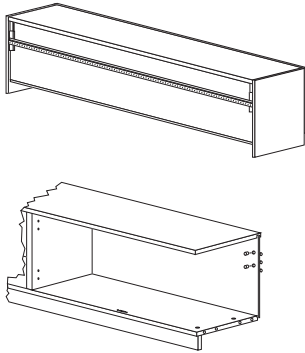

Overhead Units

The wall mount overhead storage units must be installed on wall studs. The first step for installation is to locate the studs in the wall where the overhead is to be mounted.

Position the overhead hanger rail on the wall to insure studs line up with pre-drilled holes in the hanger rail and mark the location on the wall.

Drill holes at the marked hole locations. Fasteners are to be provided by the installer, so hole size will be determined by size of fastener chosen. If studs cannot be accessed, then appropriate drywall plugs or butterfly bolts should be used. If the end of the wall rail is further than 3" from a stud, toggle bolts must be fastened through holes 1 and 3. Fasten the mounting rail to the wall insuring that it is level.

Remove the black plugs located on the inside face of the back panel to gain access to the adjusting screws on the hanging brackets. Hang the overhead on the mounting rail. The hanging brackets provide vertical and plumb adjusting screws. Level the cabinet by using these screws. All brackets must be adjusted so that they all support the cabinet.

When leveling of the overhead is complete, insert the black plugs in the holes to cover the adjusting screws.

SUGGESTED CONFIGURATIONS

EFFECTIVE MARCH 1, 2008 A PRICE INCREASE OF 5% WILL APPLY TO ALL PRODUCTS IN THIS PRICE LIST

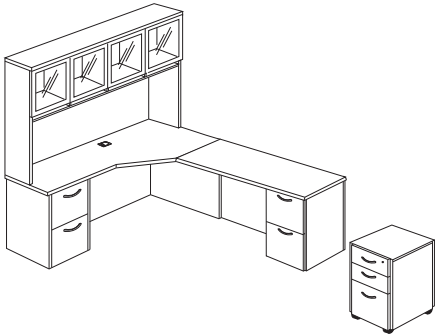

Model	Rift Oak	Cherry Maple
97CC-8424-XL4D	2029	2136
97RH-6024-XR4D	1887	1986
97MP-162028-4F	1139	1199
97HTPM-8415-40G	3147	3312
Total List	8202	8633

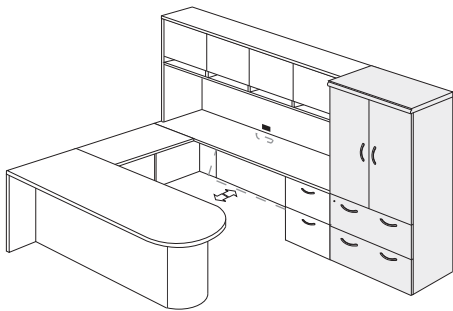
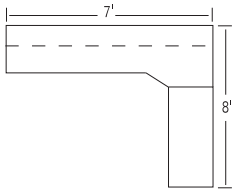

Model	Rift Oak	Cherry Maple
97BD-8436L-DBM	2293	2413
97LU-4224-HX	883	929
97TP-8424	1050	1105
97MPY-68-X41	443	467
97LB-2429	460	485
97P-1624-4D	1022	1075
97HTPM-8415-40W	2929	3077
Total List	9080	9551
97ST-362469-04	2940	3094
Total List with Storage	12020	12645

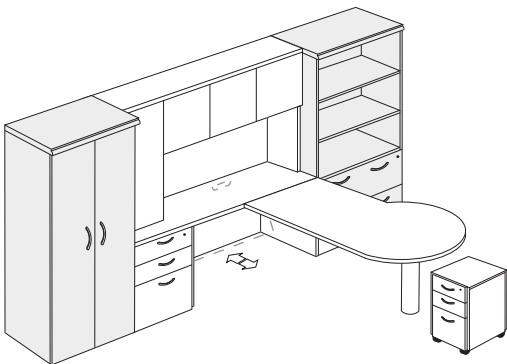
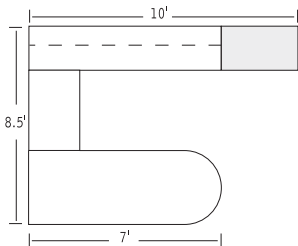

Model	Rift Oak	Cherry Maple
97PR-7230R	1796	1891
97TP-8424	1050	1105
97LB-2429	460	485
97P-1624-4D	1022	1075
97HTPR-8415-40-L110HR0	3063	3225
97MP-162028-4F	1139	1199
Total List	8530	8980
97WR-362469-03	2178	2293
97ST-362469-03	2635	2774
Total List with Storage	13343	14047

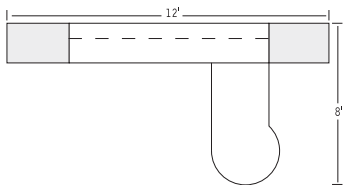

EFFECTIVE MARCH 1, 2008 A PRICE INCREASE OF 5% WILL APPLY TO ALL PRODUCTS IN THIS PRICE LIST

SUGGESTED CONFIGURATIONS

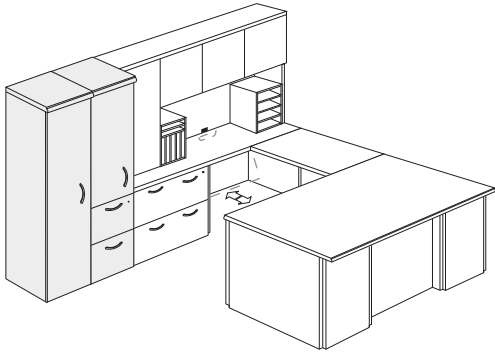

Model	Rift Oak	Cherry Maple
97D-7236-4-LORF	2339	2462
97LU-4224-HX	883	929
97CY-7224-XLFR0	2680	2821
97HTPR-7215-40-L110HR0W	2772	2911
97PM-171220-02	740	779
97PM-171220-03	740	779
Total List	10154	10681
97WR-192469-22L	1729	1820
97ST-192469-11L	1671	1758
Total List with Storage	13554	14259

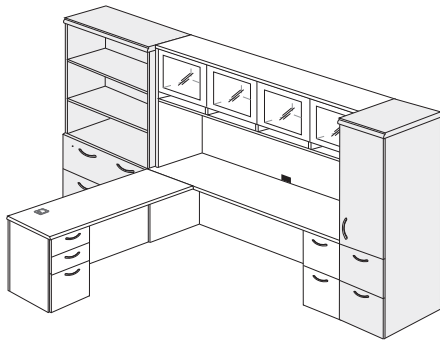
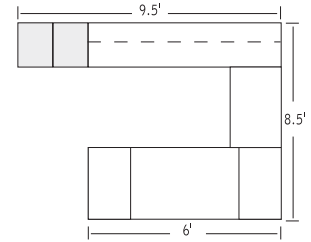

Model	Rift Oak	Cherry Maple
97CY-8424-4-XLORD	2553	2687
97RH-7224-XL4F	2070	2179
97HTPM-8415-40GW	3267	3432
9705-42	1071	1128
9710-18D29	497	523
Total List	9458	9949
97ST-192469-91R	2437	2565
97ST-362469-03	2635	2774
Total List with Storage	14530	15288

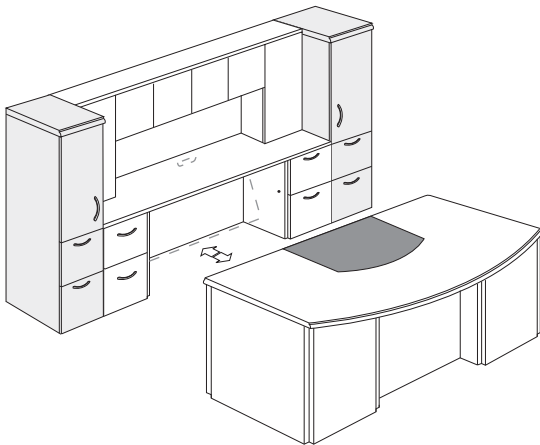
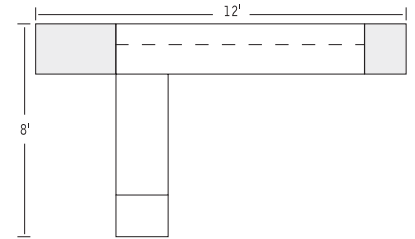

Model	Rift Oak	Cherry Maple
97D-8430-4-LFRD-BT	3325	3500
Leather Inlay	1000	1000
97TP-8424	1050	1105
97MPY-56-X41	426	449
97P-1624-4D	1022	1075
97P-1624-4D	1022	1075
97HTPR-8415-40-L110HR11	3370	3547
Total List	11215	11751
97ST-192469-91R	2437	2565
97WR-192469-22L	1729	1820
Total List with Storage	15381	16136

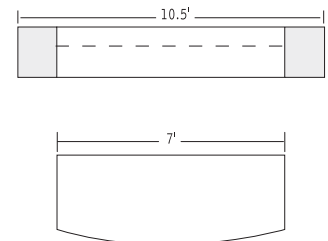

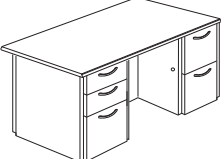
Description	Model	Rift Oak	Cherry Maple	W	D	H	KW	Shipping Weight	Cubic Feet
	97D-6030-4-LDRD	2872	3023	59.75	30.25	29.5	28.25	218	39.5
	LDRF								
	LFRD								
	LFRF								
	97D-6630-4-LDRD	2891	3044	65.75	30.25	29.5	34.25	224	43.5
	LDRF								
	LFRD								
	LFRF								
	97D-6636-4-LDRD	2906	3058	65.75	36.25	29.5	34.25	236	51
	LDRF								
	LFRD*								
	LFRF								
	97D-7230-4-LDRD	2909	3062	71.75	30.25	29.5	40.25	236	47
	LDRF								
	LFRD								
	LFRF								
	97D-7236-4-LDRD	2946	3101	71.75	36.25	29.5	40.25	248	55.5
	LDRF								
	LFRD								
	LFRF								
97D-7830-4-LDRD	2965	3121	77.75	30.25	29.5	46.25	248	51	
LDRF									
LFRD									
LFRF									
97D-7836-4-LDRD	2984	3140	77.75	36.25	29.5	46.25	260	59.5	
LDRF									
LFRD									
LFRF									
97D-8430-4-LDRD	2991	3149	83.75	30.25	29.5	52.25	266	54.5	
LDRF									
LFRD									
LFRF									
97D-8436-4-LDRD	2995	3153	83.75	26.25	29.5	52.25	272	64	
LDRF									
LFRD									
LFRF									

ORDERING NOTES

For legal sized file drawers, please add LG - before '97' in model number and add \$50 list per pedestal.
Widths above reflect letter size file drawers.

DIMENSION KEY

- W — width
- D — depth
- H — height of worksurface
- KW — kneehole width

Dimensions are in inches and approximate.
Contact Customer Service if dimensions are critical.

*Indicates model illustrated by line drawing.

CODE DESCRIPTION

- 4 — full height pedestal
- D — 2 file drawers
- F — 2 box, 1 file drawer
- L — left-hand pedestal position
- R — right-hand pedestal position

STANDARD FINISHES

For a complete list of standard wood finishes please see page 4.

BOW FRONT DESKS

The bow front adds 6" to the depth of the top at its widest point. For bow top option, please refer to page 87.

LEGAL FILE PEDESTALS

Legal file pedestals on desks are 18.75" wide.

DESKS

EFFECTIVE MARCH 1, 2008 A PRICE INCREASE OF 5% WILL APPLY TO ALL PRODUCTS IN THIS PRICE LIST

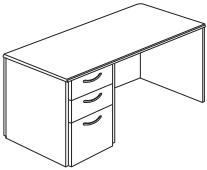
Description	Model	Rift Oak	Cherry Maple	W	D	H	KW	Shipping Weight	Cubic Feet
	97D-6030-4-LDRO	2261	2379	59.75	30.25	29.5	42.75	206	39.5
	LORD								
	LFRO								
	LORF								
	97D-6630-4-LDRO	2280	2401	65.75	30.25	29.5	48.75	212	43.5
	LORD								
	LFRO*								
	LORF								
	97D-6636-4-LDRO	2300	2421	65.75	36.25	29.5	48.75	224	51
	LORD								
	LFRO								
	LORF								
	97D-7230-4-LDRO	2302	2424	71.75	30.25	29.5	54.75	224	47
	LORD								
	LFRO								
	LORF								
	97D-7236-4-LDRO	2339	2462	71.75	36.25	29.5	54.75	236	55.5
	LORD								
LFRO									
LORF									
97D-7830-4-LDRO	2367	2492	77.75	30.25	29.5	60.75	236	51	
LORD									
LFRO									
LORF									
97D-7836-4-LDRO	2379	2505	77.75	36.25	29.5	60.75	248	59.5	
LORD									
LFRO									
LORF									
97D-8430-4-LDRO	2393	2518	83.75	30.25	29.5	65.75	250	54.5	
LORD									
LFRO									
LORF									
97D-8436-4-LDRO	2408	2535	83.75	36.25	29.5	65.75	260	64	
LORD									
LFRO									
LORF									

ORDERING NOTES

For legal sized file drawers, please add LG - before '97' in model number and add \$50 list per pedestal. Widths above reflect letter size file drawers.

ORDERING PROCEDURE

To order, please specify the following:

- 1) Krug product model number
- 2) Wood species and finish, see page 4
- 3) Pull style and finish, see page 74
- 4) Edge profile, see page 73

*Indicates model illustrated by line drawing.

CODE DESCRIPTION

- 0 — no pedestal
- 4 — full height pedestal
- D — 2 file drawers
- F — 2 box, 1 file drawer
- L — left-hand pedestal position
- R — right-hand pedestal position

STANDARD FINISHES

For a complete list of standard wood finishes please see page 4.

LEATHER INSERTS

Leather insert are available on all desks at an upcharge of \$1000 list.

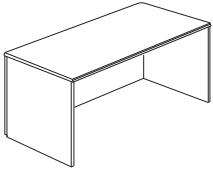
Description	Model	Rift Oak	Cherry Maple	W	D	H	KW	Shipping Weight	Cubic Feet
	97D-6030-4-LORO	1601	1685	59.75	30.25	29.5	57.25	187	34
	97D-6630-4-LORO	1620	1706	65.75	30.25	29.5	63.25	198	37
	97D-6636-4-LORO	1639	1725	65.75	36.25	29.5	63.25	215	44
	97D-7230-4-LORO	1658	1746	71.75	30.25	29.5	69.25	210	40
	97D-7236-4-LORO	1677	1765	71.75	36.25	29.5	69.25	228	48
	97D-7830-4-LORO	1705	1794	77.75	30.25	29.5	75.25	222	44
	97D-7836-4-LORO	1717	1808	77.75	36.25	29.5	75.25	241	52
	97D-8430-4-LORO	1728	1819	83.75	30.25	29.5	81.25	233	47
	97D-8436-4-LORO	1744	1835	83.75	36.25	29.5	81.25	254	56

ORDERING NOTES

Please specify a 24" deep pedestal for 30" shells and a 30" deep pedestal for 36" shells.

Bow top option	Model	Rift Oak	Cherry Maple	W	D	H	KW	Shipping Weight	Cubic Feet
	BT-97D-6030	272	286	59.75	30.25/ 36.25	-	-	-	-
	BT-97D-6630	285	301	65.75	30.25/ 36.25	-	-	-	-
	BT-97D-6636	299	314	65.75	36.25/ 41.75	-	-	-	-
	BT-97D-7230	310	327	71.75	30.25/ 36.25	-	-	-	-
	BT-97D-7236	320	337	71.75	36.25/ 41.75	-	-	-	-
	BT-97D-7830	328	345	77.75	30.25/ 36.25	-	-	-	-
	BT-97D-7836	332	349	77.75	36.25/ 41.75	-	-	-	-
	BT-97D-8430	334	351	83.75	30.25/ 36.25	-	-	-	-
	BT-97D-8436	337	354	83.75	36.25/ 41.75	-	-	-	-

ORDERING NOTES

Add BT at the end of any standard desk model number and apply the size appropriate upcharge.
Add 15 lbs. to standard desk weight for bow top option.

DIMENSION KEY

- W — width
- D — depth
- H — height of worksurface
- KW — kneehole width

Dimensions are in inches and approximate.
Contact Customer Service if dimensions are critical.

*Indicates model illustrated by line drawing.

CODE DESCRIPTION

- 0 — no pedestal
- 4 — full height modesty panel
- BT — bow top option
- L — left-hand pedestal position
- R — right-hand pedestal position

BOW FRONT DESKS

The bow front adds 6" to the depth of the top at its widest point.

WIRING GROMMETS

One rectangular grommet in a standard position is optional at no charge. Additional rectangular grommets are available at an upcharge of \$100 list.

EFFECTIVE MARCH 1, 2008 A PRICE INCREASE OF 5% WILL APPLY TO ALL PRODUCTS IN THIS PRICE LIST

CURVILINEAR DESKS

EFFECTIVE MARCH 1, 2008 A PRICE INCREASE OF 5% WILL APPLY TO ALL PRODUCTS IN THIS PRICE LIST

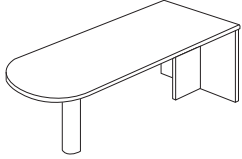
Description	Model	Rift Oak	Cherry Maple	W	D	H	KW	Shipping Weight	Cubic Feet
	97BD-6630	1716	1807	65.75	30.25	29.5	46	115	43.5
	97BD-6636*	1732	1823	65.75	36.25	29.5	43	128	51
	97BD-7230	1748	1840	71.75	30.25	29.5	52	128	47
	97BD-7236	1785	1879	71.75	36.25	29.5	49	136	55.5

ORDERING NOTES

For optional metal leg please add ML - at the end of model number and note on purchase order.

ORDERING PROCEDURE

To order, please specify the following:

- 1) Krug product model number
- 2) Wood species and finish, see page 4
- 3) Pull style and finish, see page 74
- 4) Edge profile, see page 73

*Indicates model illustrated by line drawing.

CODE DESCRIPTION

ML — optional metal leg

STANDARD FINISHES

For a complete list of standard wood finishes please see page 4.

COLUMN LEGS

All curvilinear desk column legs are 6" in diameter.

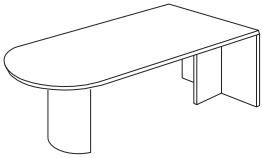
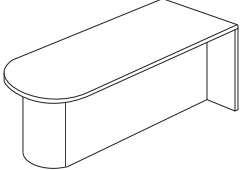
Description	Model	Rift Oak	Cherry Maple	W	D	H	KW	Shipping Weight	Cubic Feet
	Bullet desk half drum base								
	97BD-6630-DB	1928	2029	65.5	30.25	29.5	49.25	151	43.5
	97BD-6636-DB*	1944	2046	65.5	36.25	29.5	46.5	161	51
	97BD-7230-DB	1956	2059	71.5	30.25	29.5	55.25	156	47
	97BD-7236-DB	1998	2103	71.5	36.25	29.5	52.5	172	55.5
	97BD-7830-DB	2012	2118	77.5	30.25	29.5	61.25	161	51
	97BD-7836-DB	2053	2161	77.5	36.25	29.5	58.5	178	59.5
	97BD-8430-DB	2079	2188	83.5	30.25	29.5	67.25	166	54.5
97BD-8436-DB	2104	2215	83.5	36.25	29.5	64.5	183	64	
	Bullet desk full modesty panel half drum base								
	97BD-6630L-DBM	2175	2290	65.5	30.25	29.5	49.25	200	43.5
	R-DBM								
	97BD-6636L-DBM	2187	2302	65.5	36.25	29.5	46.5	215	51
	R-DBM*								
	97BD-7230L-DBM	2203	2320	71.5	30.25	29.5	55.25	211	47
	R-DBM								
	97BD-7236L-DBM	2219	2335	71.5	36.25	29.5	52.5	227	55.5
	R-DBM								
	97BD-7830L-DBM	2239	2357	77.5	30.25	29.5	61.25	216	51
	R-DBM								
	97BD-7836L-DBM	2256	2374	77.5	36.25	29.5	58.5	238	59.5
R-DBM									
97BD-8430L-DBM	2276	2396	83.5	30.25	29.5	67.25	226	54.5	
R-DBM									
97BD-8436L-DBM	2293	2413	83.5	36.25	29.5	64.5	250	64	
R-DBM									

DIMENSION KEY

- W — width
- D — depth
- H — height of worksurface
- KW — kneehole width

Dimensions are in inches and approximate.
Contact Customer Service if dimensions are critical.

*Indicates model illustrated by line drawing.

CODE DESCRIPTION

- DB — drum base
- DBM — drum base with full height modesty panel
- L — left-hand support position
- R — right-hand support position

WIRING GROMMETS

One rectangular grommet in a standard position is optional at no charge. Additional rectangular grommets are available at an upcharge of \$100 list.

EFFECTIVE MARCH 1, 2008 A PRICE INCREASE OF 5% WILL APPLY TO ALL PRODUCTS IN THIS PRICE LIST

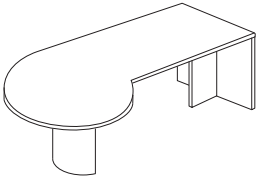
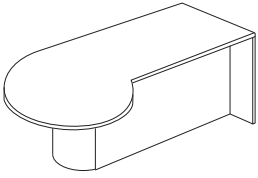
Description	Model	Rift Oak	Cherry Maple	W	D	H	KW	Shipping Weight	Cubic Feet
	97PD-6630L-4-DB	2447	2576	65.75	30.25/ 36.25	29.5	46.5	148	51
	R-4-DB								
	97PD-6636L-4-DB	2475	2605	65.75	36.25/ 41.75	29.5	43.75	163	58
	R-4-DB								
	97PD-7230L-4-DB	2500	2632	71.75	30.25/ 36.25	29.5	52.5	152	55.5
	R-4-DB								
	97PD-7236L-4-DB	2515	2648	71.75	36.25/ 41.75	29.5	49.5	168	63
	R-4-DB*								
	97PD-7830L-4-DB	2533	2666	77.5	30.25/ 36.25	29.5	58.5	156	59.5
	R-4-DB								
97PD-7836L-4-DB	2556	2691	77.5	36.25/ 41.75	29.5	55.75	173	68	
R-4-DB									
97PD-8430L-4-DB	2574	2709	83.5	30.25/ 36.25	29.5	64.5	160	64	
R-4-DB									
97PD-8436L-4-DB	2603	2740	83.5	36.25/ 41.75	29.5	61.5	178	73	
R-4-DB									
	97PD-6630L-4-DBM	2647	2786	65.75	30.25/ 36.25	29.5	46.5	196	51
	R-4-DBM								
	97PD-6636L-4-DBM	2674	2815	65.75	36.25/ 41.75	29.5	43.75	216	58
	R-4-DBM								
	97PD-7230L-4-DBM	2698	2840	71.75	30.25/ 36.25	29.5	52.5	206	55.5
	R-4-DBM								
	97PD-7236L-4-DBM	2717	2860	71.75	36.25/ 41.75	29.5	49.5	228	63
	R-4-DBM*								
	97PD-7830L-4-DBM	2741	2885	77.5	30.25/ 36.25	29.5	58.5	216	59.5
	R-4-DBM								
97PD-7836L-4-DBM	2760	2906	77.5	36.25/ 41.75	29.5	55.75	239	68	
R-4-DBM									
97PD-8430L-4-DBM	2785	2931	83.5	30.25/ 36.25	29.5	64.5	226	64	
R-4-DBM									
97PD-8436L-4-DBM	2809	2956	83.5	36.25/ 41.75	29.5	61.5	251	73	
R-4-DBM									

DIMENSION KEY

- W — width
- D — depth
- H — height of worksurface
- KW — kneehole width

Dimensions are in inches and approximate.
Contact Customer Service if dimensions are critical.

*Indicates model illustrated by line drawing.

CODE DESCRIPTION

- 4 — full height modesty panel
- L — left-hand support position
- R — right-hand support position
- DB — drum base
- DBM — drum base with full height modesty panel
- ML — optional metal leg

WIRING GROMMETS

One rectangular grommet in a standard position is optional at no charge. Additional rectangular grommets are available at an upcharge of \$100 list.

EFFECTIVE MARCH 1, 2008 A PRICE INCREASE OF 5% WILL APPLY TO ALL PRODUCTS IN THIS PRICE LIST

RETURNS

EFFECTIVE MARCH 1, 2008 A PRICE INCREASE OF 5% WILL APPLY TO ALL PRODUCTS IN THIS PRICE LIST

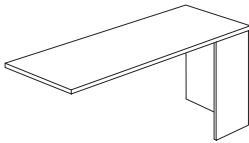
Description	Model	Rift Oak	Cherry Maple	W	D	H	KW	Shipping Weight	Cubic Feet
	97RH-4220-L R	891	938	42	20	29.5	40.75	72	20
	97RH-4224-L R	915	963	42	24	29.5	40.75	80	23.5
	97RH-4820-L R	941	991	48	20	29.5	46.75	80	22.5
	97RH-4824-L R	965	1016	48	24	29.5	46.75	88	26.5
	97RH-5420-L R	979	1030	53.75	20	29.5	52.5	88	25
	97RH-5424-L R	995	1048	53.75	24	29.5	52.5	96	29.5
	97RH-6020-L R	1010	1064	59.75	20	29.5	58.5	96	28
	97RH-6024-L R	1028	1083	59.75	24	29.5	58.5	94	32.5
	97RH-6620-L R	1045	1100	65.75	20	29.5	64.5	96	30.5
	97RH-6624-L* R	1059	1114	65.75	24	29.5	64.5	94	35.5
	97RH-7220-L R	1077	1134	71.75	20	29.5	70.5	112	33
	97RH-7224-L R	1088	1145	71.75	24	29.5	70.5	112	38.5

ORDERING NOTES

A support panel is required for unsupported spans greater than 60".
Free standing pedestals cannot be specified in 20" deep open returns.

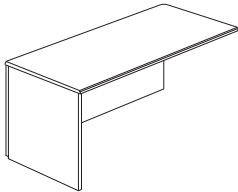
	97RH-4224-XL XR	1026	1079	42	24	29.5	40.75	98	23.5
	97RH-4824-XL* XR	1090	1147	48	24	29.5	46.75	108	26.5
	97RH-5424-XL XR	1137	1197	53.75	24	29.5	52.5	118	29.5
	97RH-6024-XL XR	1185	1247	59.75	24	29.5	58.5	120	32.5

ORDERING PROCEDURE

To order, please specify the following:

- 1) Krug product model number
- 2) Wood species and finish, see page 4
- 3) Pull style and finish, see page 74
- 4) Edge profile, see page 73

*Indicates model illustrated by line drawing.

CODE DESCRIPTION

- L — left-hand position
- R — right-hand position
- X — includes modesty panel

MODESTY PANELS

Open returns are available with half modesty panels at no upcharge. State clearly on Purchase Order.

WIRE MANAGEMENT CUT-OUTS

A wire management cut-out is available on full modesty panels. Note clearly on Purchase Order and add \$150 list upcharge.

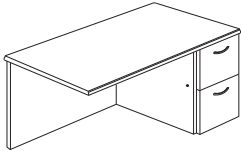
Description	Model	Rift Oak	Cherry Maple	W	D	H	KW	Shipping Weight	Cubic Feet
Single pedestal return full modesty panel 	97RH-4220-XL4D	1732	1823	42	20	29.5	26.25	100	20
	XR4D								
	XL4F								
	XR4F								
	97RH-4224-XL4D	1757	1850	42	24	29.5	26.25	104	23.5
	XR4D								
	XL4F								
	XR4F								
	97RH-4820-XL4D	1771	1863	48	20	29.5	32.25	104	22.5
	XR4D								
	XL4F								
	XR4F								
	97RH-4824-XL4D	1778	1872	48	24	29.5	32.25	108	26.5
	XR4D								
	XL4F								
	XR4F								
	97RH-5420-XL4D	1793	1888	53.75	20	29.5	38	108	25
	XR4D								
XL4F									
XR4F									
97RH-5424-XL4D	1815	1911	53.75	24	29.5	38	120	29.5	
XR4D									
XL4F									
XR4F									
97RH-6020-XL4D	1853	1951	59.75	20	29.5	44	120	28	
XR4D*									
XL4F									
XR4F									
97RH-6024-XL4D	1887	1986	59.75	24	29.5	44	128	32.5	
XR4D									
XL4F									
XR4F									

ORDERING NOTES

For legal sized file drawers, please add LG - before '97' in model number and add \$50 list per pedestal.
Widths above reflect letter size file drawers.

DIMENSION KEY

- W — width
- D — depth
- H — height of worksurface
- KW — kneehole width

Dimensions are in inches and approximate.
Contact Customer Service if dimensions are critical.

*Indicates model illustrated by line drawing.

CODE DESCRIPTION

- D — 2 file drawers
- F — 2 box, 1 file drawer
- L — left-hand pedestal position
- R — right-hand pedestal position
- X — includes a modesty panel

STANDARD FINISHES

For a complete list of standard wood finishes please see page 4.

WIRING GROMMETS

One rectangular grommet in a standard position is optional at no charge. Additional rectangular grommets are available at an upcharge of \$100 list.

LOCKS

Locks are standard on all pedestals and lateral file drawers.

EFFECTIVE MARCH 1, 2008 A PRICE INCREASE OF 5% WILL APPLY TO ALL PRODUCTS IN THIS PRICE LIST

RETURNS

EFFECTIVE MARCH 1, 2008 A PRICE INCREASE OF 5% WILL APPLY TO ALL PRODUCTS IN THIS PRICE LIST

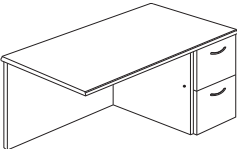
Description	Model	Rift Oak	Cherry Maple	W	D	H	KW	Shipping Weight	Cubic Feet
Single pedestal return full modesty panel c o n t i n u e d 	97RH-6620-XL4D	1982	2086	65.75	20	29.5	50	128	30.5
	XR4D								
	XL4F								
	XR4F								
	97RH-6624-XL4D	2004	2109	65.75	24	29.5	50	136	35.5
	XR4D*								
	XL4F								
	XR4F								
	97RH-7220-XL4D	2046	2154	71.75	20	29.5	56	136	33
	XR4D								
	XL4F								
	XR4F								
97RH-7224-XL4D	2070	2179	71.75	24	29.5	56	144	38.5	
XR4D									
XL4F									
XR4F									
97RH-8420-XL4D	2113	2224	83.5	19.75	29.5	68	165	38	
XR4F									
XL4F									
XR4F									
97RH-8424-XL4D	2137	2250	83.5	24	29.5	68	183	44.5	
XR4D									
XL4F									
XR4F									

ORDERING NOTES

For legal sized file drawers, please add LG - before '97' in model number and add \$50 list per pedestal.
Widths above reflect letter size file drawers.

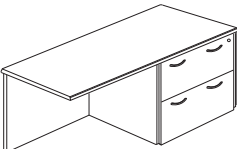
Return with lateral file full modesty panel 	97RH-6020-XLLF36	2278	2398	59.75	20	29.5	24	160	28
	XRLF36								
	97RH-6024-XLLF36	2294	2414	59.75	24	29.5	24	168	32.5
	XRLF36								
	97RH-6620-XLLF36	2323	2445	65.75	20	29.5	30	172	30.5
XRLF36									
97RH-6624-XLLF36	2339	2462	65.75	24	29.5	30	176	35.5	
XRLF36*									

ORDERING PROCEDURE

To order, please specify the following:

- 1) Krug product model number
- 2) Wood species and finish, see page 4
- 3) Pull style and finish, see page 74
- 4) Edge profile, see page 73

*Indicates model illustrated by line drawing.

CODE DESCRIPTION

- D — 2 file drawers
- F — 2 box, 1 file drawer
- L — left-hand pedestal position
- R — right-hand pedestal position
- LF — lateral file pedestal
- X — includes a modesty panel

STANDARD FINISHES

For a complete list of standard wood finishes please see page 4.

MODESTY PANELS

Open returns are available with half modesty panels at no upcharge. Please specify at time of order.

LOCKS

Locks are standard on all pedestals and lateral file drawers.

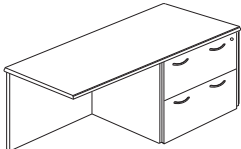
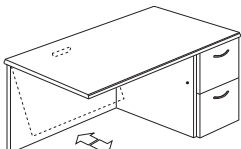
Description	Model	Rift	Cherry	W	D	H	KW	Shipping Weight	Cubic Feet
		Oak	Maple						
Return with lateral file full modesty panel <i>continued</i> 	97RH-7220-XLLF36 XRLF36	2368	2493	71.75	20	29.5	36	184	33
	97RH-7224-XLLF36 XRLF36	2383	2509	71.75	24	29.5	36	188	38.5
	97RH-7820-XLLF36 XRLF36	2413	2540	77.75	20	29.5	42	192	35.5
	97RH-7824-XLLF36 XRLF36	2429	2556	77.75	24	29.5	42	196	41.5
	97RH-8420-XLLF36 XRLF36	2458	2587	83.75	20	29.5	48	200	38
	97RH-8424-XLLF36 XRLF36	2475	2605	83.75	24	29.5	48	204	44.5
	Single pedestal return hinged modesty panel 	97RHY-4220-L4D R4D L4F R4F	1907	2006	42	20	29.5	26.25	100
	97RHY-4224-L4D R4D L4F R4F	1932	2034	42	24	29.5	26.25	104	23.5
	97RHY-4820-L4D R4D L4F R4F	1948	2050	48	20	29.5	32.25	104	22.5
	97RHY-4824-L4D R4D L4F R4F	1960	2063	48	24	29.5	32.25	108	26.5
	97RHY-5420-L4D R4D L4F R4F	1973	2078	53.75	20	29.5	38	108	25

ORDERING NOTES

For legal sized file drawers, please add LG - before '97' in model number and add \$50 list per pedestal.
 Widths above reflect letter size file drawers.
 A wire management cut-out is standard on hinged modesty panels.

DIMENSION KEY

- W — width
- D — depth
- H — height of worksurface
- KW — kneehole width

Dimensions are in inches and approximate.
 Contact Customer Service if dimensions are critical.

*Indicates model illustrated by line drawing.

CODE DESCRIPTION

- D — 2 file drawers
- F — 2 box, 1 file drawer
- L — left-hand pedestal position
- R — right-hand pedestal position
- LF — lateral file pedestal
- X — includes a modesty panel
- Y — hinged modesty panel

WIRING GROMMETS

One rectangular grommet in a standard position is optional at no charge. Additional rectangular grommets are available at an upcharge of \$100 list.

EFFECTIVE MARCH 1, 2008 A PRICE INCREASE OF 5% WILL APPLY TO ALL PRODUCTS IN THIS PRICE LIST

RETURNS

EFFECTIVE MARCH 1, 2008 A PRICE INCREASE OF 5% WILL APPLY TO ALL PRODUCTS IN THIS PRICE LIST

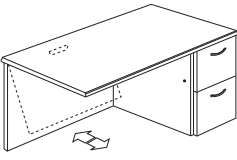
Description	Model	Rift Oak	Cherry Maple	W	D	H	KW	Shipping Weight	Cubic Feet
Single pedestal return hinged modesty panel c o n t i n u e d 	97RHY-5424-L4D	1997	2102	53.75	24	29.5	38	120	29.5
	R4D								
	L4F								
	R4F								
	97RHY-6020-L4D	2038	2145	59.75	20	29.5	44	120	28
	R4D								
	L4F								
	R4F								
	97RHY-6024-L4D	2075	2185	59.75	24	29.5	44	128	32.5
	R4D*								
	L4F								
	R4F								
97RHY-6620-L4D	2181	2295	65.75	20	29.5	50	128	30.5	
R4D									
L4F									
R4F									
97RHY-6624-L4D	2203	2320	65.75	24	29.5	50	136	35.5	
R4D									
L4F									
R4F									
97RHY-7220-L4D	2251	2369	71.75	20	29.5	56	136	33	
R4D									
L4F									
R4F									
97RHY-7224-L4D	2278	2398	71.75	24	29.5	56	144	38.5	
R4D									
L4F									
R4F									
97RHY-8420-L4D	2326	2448	83.5	19.75	29.5	68	165	38	
R4F									
L4F									
R4F									
97RHY-8424-L4D	2355	2478	83.5	24	29.5	68	183	44.5	
R4D									
L4F									
R4F									

ORDERING NOTES

A wire management cut-out is standard on hinged modesty panels.

ORDERING PROCEDURE

To order, please specify the following:

- 1) Krug product model number
- 2) Wood species and finish, see page 4
- 3) Pull style and finish, see page 74
- 4) Edge profile, see page 73

*Indicates model illustrated by line drawing.

CODE DESCRIPTION

- 4 — full height pedestal
- D — 2 file drawers
- F — 2 box, 1 file drawer
- L — left-hand pedestal position
- R — right-hand pedestal position

STANDARD FINISHES

For a complete list of standard wood finishes please see page 4.

MODESTY PANELS

Open returns are available with half modesty panels at no upcharge. Please specify at time of order.

LOCKS

Locks are standard on all pedestals and lateral file drawers.

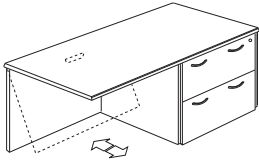
Description	Model	Rift Oak	Cherry Maple	W	D	H	KW	Shipping Weight	Cubic Feet
 <p>Return with lateral file hinged modesty panel</p>	97RHY-6020-LLF36 RLF36	2506	2638	59.75	20	29.5	24	160	28
	97RHY-6024-LLF36 RLF36	2522	2655	59.75	24	29.5	24	168	32.5
	97RHY-6620-LLF36 RLF36	2554	2689	65.75	20	29.5	30	172	30.5
	97RHY-6624-LLF36 RLF36*	2573	2708	65.75	24	29.5	30	176	35.5
	97RHY-7220-LLF36 RLF36	2605	2742	71.75	20	29.5	36	184	33
	97RHY-7224-LLF36 RLF36	2622	2760	71.75	24	29.5	36	188	38.5
	97RHY-7820-LLF36 RLF36	2654	2794	77.75	20	29.5	42	192	35.5
	97RHY-7824-LLF36 RLF36	2672	2812	77.75	24	29.5	42	196	41.5
	97RHY-8420-LLF36 RLF36	2704	2846	83.75	20	29.5	48	200	38
	97RHY-8424-LLF36 RLF36	2722	2865	83.75	24	29.5	48	204	44.5

ORDERING NOTES

A wire management cut-out is standard on hinged modesty panels.

DIMENSION KEY

- W — width
- D — depth
- H — height of worksurface
- KW — kneehole width

Dimensions are in inches and approximate.
Contact Customer Service if dimensions are critical.

*Indicates model illustrated by line drawing.

CODE DESCRIPTION

- L — left-hand pedestal position
- R — right-hand pedestal position
- LF — lateral file pedestal
- Y — hinged modesty panel

WIRING GROMMETS

One rectangular grommet in a standard position is optional at no charge. Additional rectangular grommets are available at an upcharge of \$100 list.

EFFECTIVE MARCH 1, 2008 A PRICE INCREASE OF 5% WILL APPLY TO ALL PRODUCTS IN THIS PRICE LIST

CURVILINEAR RETURNS

EFFECTIVE MARCH 1, 2008 A PRICE INCREASE OF 5% WILL APPLY TO ALL PRODUCTS IN THIS PRICE LIST

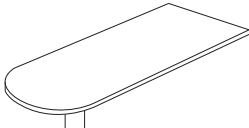
Description	Model	Rift Oak	Cherry Maple	W	D	H	KW	Shipping Weight	Cubic Feet
	97BR-6030	1111	1170	59.75	29.75	29.5	42	67	5.75
	97BR-6630	1128	1188	65.75	29.75	29.5	48	71	6
	97BR-6636	1141	1201	65.75	35.75	29.5	45	128	7
	97BR-7230	1171	1233	71.75	29.75	29.5	54	90	6.75
	97BR-7236*	1199	1262	71.75	35.75	29.5	51	76	7.5
	97BR-8436	1259	1325	83.75	35.75	29.5	63	99	8.75

ORDERING NOTES

For optional metal leg please add ML - at the end of model number and note on purchase order.

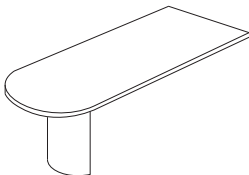
	Bullet return half drum base	97BR-6030-DB	1288	1355	59.75	29.75	29.5	43.5	117	10.25
		97BR-6036-DB	1297	1365	59.75	35.75	29.5	40.5	126	11
		97BR-6630-DB	1306	1375	65.75	29.75	29.5	49.5	121	10.75
		97BR-6636-DB	1316	1385	65.75	35.75	29.5	46.5	132	11.5
		97BR-7230-DB	1347	1418	71.75	29.75	29.5	55.5	126	11.25
		97BR-7236-DB*	1375	1447	71.75	35.75	29.5	52.5	138	12
		97BR-7830-DB	1402	1476	77.25	29.75	29.5	61.5	131	11.5
		97BR-7836-DB	1431	1506	77.25	35.75	29.5	58.5	144	12.75
		97BR-8430-DB	1458	1535	83.75	29.75	29.5	67.5	136	12
		97BR-8436-DB	1485	1564	83.75	35.75	29.5	64.5	149	13.25

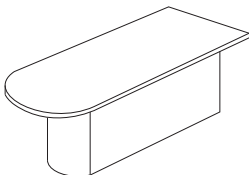
	Bullet return half drum base full modesty panel	97BR-6030L-DBM	1488	1567	59.75	29.75	29.5	44.5	166	39.5
		R-DBM								
		97BR-6036L-DBM	1498	1577	59.75	35.75	29.5	41.5	176	46.5
		R-DBM								
		97BR-6630L-DBM	1507	1586	65.75	29.75	29.5	50.5	177	43.5
		R-DBM								
		97BR-6636L-DBM	1517	1598	65.75	35.75	29.5	47.5	189	51
		R-DBM								
		97BR-7230L-DBM	1579	1662	71.75	29.75	29.5	56.5	188	49.5
		R-DBM								
		97BR-7236L-DBM	1607	1691	71.75	35.75	29.5	53.5	200	55.5
		R-DBM*								
		97BR-7830L-DBM	1635	1721	77.25	29.75	29.5	62.5	193	51
		R-DBM								
		97BR-7836L-DBM	1662	1750	77.25	35.75	29.5	59.5	211	59.5
		R-DBM								
	97BR-8430L-DBM	1711	1800	83.75	29.75	29.5	68.5	203	54.5	
	R-DBM									
	97BR-8436L-DBM	1739	1830	83.75	35.75	29.5	65.5	223	64	
	R-DBM									

ORDERING PROCEDURE

To order, please specify the following:

- 1) Krug product model number
- 2) Wood species and finish, see page 4
- 3) Pull style and finish, see page 74
- 4) Edge profile, see page 73

*Indicates model illustrated by line drawing.

CODE DESCRIPTION

- L — left-hand support position
- R — right-hand support position
- DB — drum base
- DBM — drum base with full height modesty panel
- ML — optional metal leg

STANDARD FINISHES

For a complete list of standard wood finishes please see page 4.

CURVILINEAR RETURNS

Curvilinear returns without a modesty panel are shipped knocked down and in 2 cartons.

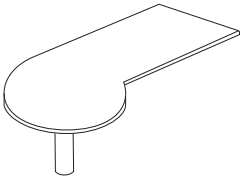
Description	Model	Rift Oak	Cherry Maple	W	D	H	KW	Shipping Weight	Cubic Feet
	97PR-6636L R	1766	1859	65.75	35.75/ 41.75	29.5	42	128	8
	97PR-7230L R	1796	1891	71.75	29.75/ 35/75	29.5	52	120	7.5
	97PR-7236L R*	1825	1921	71.75	35.75/ 41.75	29.5	48	136	8.5
	97PR-8436L R	1883	1982	83.75	35.75/ 41.75	29.5	60	144	9.75

ORDERING NOTES

For optional metal leg please add ML - at the end of model number and note on purchase order.

DIMENSION KEY

- W — width
- D — depth
- H — height of worksurface
- KW — kneehole width

Dimensions are in inches and approximate.
Contact Customer Service if dimensions are critical.

*Indicates model illustrated by line drawing.

CODE DESCRIPTION

- L — left-hand support position
- R — right-hand support position
- ML — optional metal leg

COLUMN LEGS

All curvilinear desk column legs are 6" in diameter.

WIRING GROMMETS

One wiring grommet in standard position is optional at no charge. Additional wiring grommets are available at an upcharge of \$100 list. See pages 75 and 76 for more wiring grommet information.

CURVILINEAR RETURNS

EFFECTIVE MARCH 1, 2008 A PRICE INCREASE OF 5% WILL APPLY TO ALL PRODUCTS IN THIS PRICE LIST

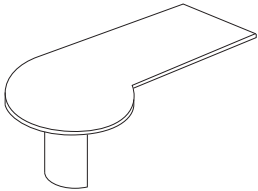
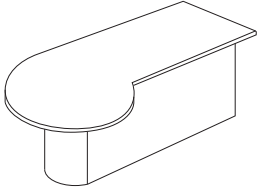
Description	Model	Rift Oak	Cherry Maple	W	D	H	KW	Shipping Weight	Cubic Feet	
	P return half drum base	1887	1986	59.75	29.25/ 35.75	29.5	40.75	114	11	
	97PR-6030L-DB R-DB	1902	2002	59.75	35.75/ 41.75	29.5	37.75	123	11.75	
	97PR-6630L-DB R-DB	1914	2015	65.75	29.25/ 35.75	29.5	46.75	118	11.5	
	97PR-6636L-DB R-DB	1943	2045	65.75	35.75/ 41.75	29.5	43.75	129	12.5	
	97PR-7230L-DB R-DB	1993	2098	71.75	29.25/ 35.75	29.5	52.75	122	12	
	97PR-7236L-DB R-DB*	2021	2127	71.75	35.75/ 41.75	29.5	49.75	134	13	
	97PR-7830L-DB R-DB	2049	2157	77.25	29.25/ 35.75	29.5	58.75	126	12.75	
	97PR-7836L-DB R-DB	2076	2186	77.25	35.75/ 41.75	29.5	55.75	137	13.75	
	97PR-8430L-DB R-DB	2104	2215	83.75	29.25/ 35.75	29.5	64.75	130	13.25	
	97PR-8436L-DB R-DB	2145	2259	83.75	35.75/ 41.75	29.5	61.75	139.5	14.25	
		P return half drum base full modesty	2083	2192	59.75	29.75/ 35.75	29.5	40.5	164	46.5
		97PR-6036L-4-DBM R-4-DBM	2098	2208	59.75	35.75/ 41.75	29.5	37.75	178	53
97PR-6630L-4-DBM R-4-DBM		2110	2222	65.75	29.75/ 35.75	29.5	46.5	174	51	
97PR-6636L-4-DBM R-4-DBM		2138	2251	65.75	35.75/ 41.75	29.5	43.75	189	58	
97PR-7230L-4-DBM R-4-DBM		2236	2354	71.75	29.75/ 35.75	29.5	52	184	55.5	
97PR-7236L-4-DBM R-4-DBM*		2258	2376	71.75	35.75/ 41.75	29.5	49.25	201	63	
97PR-7830L-4-DBM R-4-DBM		2292	2412	77.25	29.75/ 35.75	29.5	58	194	59.5	
97PR-7836L-4-DBM R-4-DBM		2329	2451	77.25	35.75/ 41.75	29.5	55.25	212	68	
97PR-8430L-4-DBM R-4-DBM		2367	2492	83.75	29.75/ 35.75	29.5	69	204	64	
97PR-8436L-4-DBM R-4-DBM		2416	2543	83.75	35.75/ 41.75	29.5	61.25	224	73	

ORDERING PROCEDURE

To order, please specify the following:

- 1) Krug product model number
- 2) Wood species and finish, see page 4
- 3) Pull style and finish, see page 74
- 4) Edge profile, see page 73

*Indicates model illustrated by line drawing.

CODE DESCRIPTION

- L — left-hand support position
- R — right-hand support position
- DB — drum base
- DBM — drum base with full height modesty panel

STANDARD FINISHES

For a complete list of standard wood finishes please see page 4.

CURVILINEAR RETURNS

Curvilinear returns without a modesty panel are shipped knocked down and in 2 cartons.

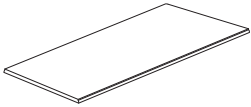
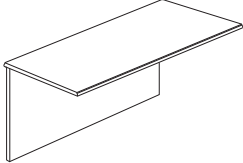
Description	Model	Rift Oak	Cherry Maple	W	D	H	Shipping Weight	Cubic Feet	
	97LU-3620-H	402	422	36	20	29.5	24	2.25	
	97LU-3624-H	409	431	36	24	29.5	28	2.5	
	97LU-4220-H	422	445	42	20	29.5	28	2.5	
	97LU-4224-H	433	455	42	24	29.5	33	2.75	
	97LU-4820-H	440	462	48	20	29.5	31	2.75	
	97LU-4824-H	452	476	48	24	29.5	37	3.25	
	97LU-5420-H	462	487	53.75	20	29.5	35	3	
	97LU-5424-H	474	499	53.75	24	29.5	42	3.5	
	97LU-6020-H*	486	512	59.75	20	29.5	39	3.25	
	97LU-6024-H	497	523	59.75	24	29.5	46	4	
	97LU-6620-H	510	537	65.75	20	29.5	43	3.75	
	97LU-6624-H	519	546	65.75	24	29.5	51	4.25	
	97LU-7220-H	531	559	71.75	20	29.5	46	4	
	97LU-7224-H	540	569	71.75	24	29.5	55	4.5	
	97LU-7820-H	553	582	77.75	20	29.5	50	4.25	
	97LU-7824-H	561	591	77.75	24	29.5	60	5	
	97LU-8420-H	575	605	83.75	20	29.5	53	4.5	
	97LU-8424-H	583	614	83.75	24	29.5	64	5.25	
		97LU-3620-HX	804	847	36	20	29.5	54	3.5
		97LU-3624-HX	842	886	36	24	29.5	59	3.5
97LU-4220-HX		868	914	42	20	29.5	62	4	
97LU-4224-HX		883	929	42	24	29.5	68	4	
97LU-4820-HX		906	954	48	20	29.5	71	4.5	
97LU-4824-HX		918	966	48	24	29.5	77	4.5	
97LU-5420-HX		946	995	53.75	20	29.5	79	5	
97LU-5424-HX		956	1006	53.75	24	29.5	85	5	
97LU-6020-HX*		988	1039	59.75	20	29.5	87	5.5	
97LU-6024-HX		994	1046	59.75	24	29.5	94	5.5	
97LU-6620-HX		1031	1086	65.75	20	29.5	95	6	
97LU-6624-HX		1068	1125	65.75	24	29.5	103	6	
97LU-7220-HX		1106	1164	71.75	20	29.5	103	6.5	
97LU-7224-HX		1143	1203	71.75	24	29.5	112	6.5	
97LU-7820-HX		1179	1241	77.75	20	29.5	111	7	
97LU-7824-HX		1216	1280	77.75	24	29.5	121	7	
97LU-8420-HX		1254	1319	83.75	20	29.5	120	7.5	
97LU-8424-HX		1291	1359	83.75	24	29.5	130	7.5	

ORDERING NOTES

A half gable support is required on any open spans greater than 60" that doesn't have a modesty panel.

DIMENSION KEY

- W — width
- D — depth
- H — height of worksurface

Dimensions are in inches and approximate.
Contact Customer Service if dimensions are critical.

*Indicates model illustrated by line drawing.

CODE DESCRIPTION

- H — desk height
- X — includes modesty panel

WIRING GROMMETS

One wiring grommet in standard position is optional at no charge. Additional wiring grommets are available at an upcharge of \$100 list. See pages 75 and 76 for more wiring grommet information.

EFFECTIVE MARCH 1, 2008 A PRICE INCREASE OF 5% WILL APPLY TO ALL PRODUCTS IN THIS PRICE LIST

LINKING UNITS | CORNER UNITS

EFFECTIVE MARCH 1, 2008 A PRICE INCREASE OF 5% WILL APPLY TO ALL PRODUCTS IN THIS PRICE LIST

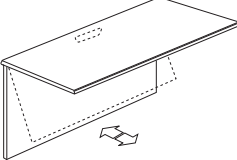
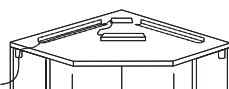
Description	Model	Wood Species		W	D	H	Y	KW	Shipping Weight	Cubic Feet
		Rift Oak	Cherry Maple							
Linking unit hinged modesty panel 	97LUY-3620-H	885	931	36	20	29.5	-	-	54	3.5
	97LUY-3624-H	926	974	36	24	29.5	-	-	59	3.5
	97LUY-4220-H	956	1006	42	20	29.5	-	-	62	4
	97LUY-4224-H	970	1022	42	24	29.5	-	-	68	4
	97LUY-4820-H	997	1050	48	20	29.5	-	-	71	4.5
	97LUY-4824-H	1008	1062	48	24	29.5	-	-	77	4.5
	97LUY-5420-H	1040	1095	53.75	20	29.5	-	-	79	5
	97LUY-5424-H	1051	1106	53.75	24	29.5	-	-	85	5
	97LUY-6020-H*	1087	1143	59.75	20	29.5	-	-	87	5.5
	97LUY-6024-H	1094	1152	59.75	24	29.5	-	-	94	5.5
	97LUY-6620-H	1131	1191	65.75	20	29.5	-	-	95	6
	97LUY-6624-H	1168	1230	65.75	24	29.5	-	-	103	6
	97LUY-7220-H	1205	1269	71.75	20	29.5	-	-	103	6.5
	97LUY-7224-H	1242	1307	71.75	24	29.5	-	-	112	6.5
	97LUY-7820-H	1279	1346	77.75	20	29.5	-	-	111	7
	97LUY-7824-H	1316	1385	77.75	24	29.5	-	-	121	7
	97LUY-8420-H	1353	1424	83.75	20	29.5	-	-	120	7.5
97LUY-8424-H	1391	1464	83.75	24	29.5	-	-	130	7.5	
Corner unit 	97CU-3636-20	1598	1682	36	36	29.5	16.75	22.5	106	27
	97CU-3636-24*	1598	1682	36	36	29.5	16.75	16.75	131	36
	97CU-4242-20	1757	1850	42	42	29.5	16.75	31	131	36
	97CU-4242-24	1757	1850	42	42	29.5	16.75	25.25	131	36

ORDERING NOTES

One rectangular grommet comes standard at the back corner in "C" position. Additional grommets are not available.

ORDERING PROCEDURE

To order, please specify the following:

- 1) Krug product model number
- 2) Wood species and finish, see page 4
- 3) Pull style and finish, see page 74
- 4) Edge profile, see page 73

*Indicates model illustrated by line drawing.

CODE DESCRIPTION

- H — desk height modesty panel
- Y — hinged modesty panel

STANDARD FINISHES

For a complete list of standard wood finishes please see page 4.

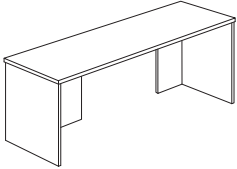
Description	Model	Rift		W	D	H	KW	Shipping Weight	Cubic Feet
		Oak	Cherry Maple						
 <p>Credenza shell with L-supports</p>	97C-6020-4-LORO	1069	1126	59.75	20	29.5	57.5	88	25
	97C-6024-4-LORO	1126	1186	59.75	24	29.5	57.5	96	30
	97C-6620-4-LORO	1177	1239	65.75	20	29.5	63.5	96	28
	97C-6624-4-LORO	1238	1303	65.75	24	29.5	63.5	104	33
	97C-7220-4-LORO*	1255	1320	71.75	20	29.5	69.5	104	33
	97C-7224-4-LORO	1315	1384	71.75	24	29.5	69.5	112	38.5
	97C-7820-4-LORO	1330	1400	77.75	20	29.5	75.5	112	35.5
	97C-7824-4-LORO	1383	1456	77.75	24	29.5	75.5	120	41.5
	97C-8420-4-LORO	1406	1480	83.75	20	29.5	81.5	120	38
	97C-8424-4-LORO	1461	1538	83.75	24	29.5	81.5	128	44.5

ORDERING NOTES

20" Shells cannot be specific with free standing pedestals.

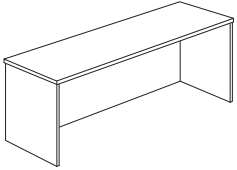
Description	Model	Rift		W	D	H	KW	Shipping Weight	Cubic Feet
		Oak	Cherry Maple						
 <p>Credenza shell full modesty panel</p>	97C-6020-4-XLORO	1268	1335	59.75	20	29.5	57.5	88	28
	97C-6024-4-XLORO	1280	1347	59.75	24	29.5	57.5	96	32.5
	97C-6620-4-XLORO	1394	1467	65.75	20	29.5	63.5	96	30.5
	97C-6624-4-XLORO	1406	1480	65.75	24	29.5	63.5	104	35.5
	97C-7220-4-XLORO*	1486	1565	71.75	20	29.5	69.5	104	33
	97C-7224-4-XLORO	1502	1581	71.75	24	29.5	69.5	112	38.5
	97C-7820-4-XLORO	1570	1652	77.75	20	29.5	75.5	112	35.5
	97C-7824-4-XLORO	1586	1670	77.75	24	29.5	75.5	120	41.5
	97C-8420-4-XLORO	1661	1749	83.75	20	29.5	81.5	120	38
	97C-8424-4-XLORO	1679	1767	83.75	24	29.5	81.5	128	44.5

ORDERING NOTES

20" Shells cannot be specific with free standing pedestals.

DIMENSION KEY

- W — width
- D — depth
- H — height of worksurface
- KW — kneehole width

Dimensions are in inches and approximate.
Contact Customer Service if dimensions are critical.

*Indicates model illustrated by line drawing.

CODE DESCRIPTION

- O — no pedestal
- 4 — full height pedestal
- L — left-hand position
- R — right-hand position
- X — includes a modesty panel

MODULAR PEDESTALS

Please see page 115 for modular pedestals to be used in conjunction with shells.

WIRING GROMMETS

One rectangular grommet in a standard position is optional at no charge. Additional rectangular grommets are available at an upcharge of \$100 list.

EFFECTIVE MARCH 1, 2008 A PRICE INCREASE OF 5% WILL APPLY TO ALL PRODUCTS IN THIS PRICE LIST

CREDENZAS

EFFECTIVE MARCH 1, 2008 A PRICE INCREASE OF 5% WILL APPLY TO ALL PRODUCTS IN THIS PRICE LIST

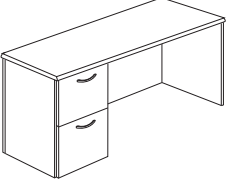
Description	Model	Rift Oak	Cherry Maple	W	D	H	KW	Shipping Weight	Cubic Feet
Single pedestal credenza full modesty panel 	97C-6020-4-XLDRO	2225	2342	59.75	20	29.5	43	120	28
	XLORD								
	XLFRO								
	XLORF								
	97C-6024-4-XLDRO	2241	2360	59.75	24	29.5	43	128	32.5
	XLORD								
	XLFRO								
	XLORF								
	97C-6620-4-XLDRO*	2261	2379	65.75	20	29.5	49	136	30.5
	XLORD								
	XLFRO								
	XLORF								
	97C-6624-4-XLDRO	2271	2391	65.75	24	29.5	49	144	35.5
	XLORD								
	XLFRO								
	XLORF								
	97C-7220-4-XLDRO	2280	2401	71.75	20	29.5	55	152	33
	XLORD								
XLFRO									
XLORF									
97C-7224-4-XLDRO	2300	2421	71.75	24	29.5	55	160	38.5	
XLORD									
XLFRO									
XLORF									

ORDERING NOTES

For legal sized file drawers, please add LG - before '97' in model number and add \$50 list per pedestal. Widths above reflect letter size file drawers.

ORDERING PROCEDURE

To order, please specify the following:

- 1) Krug product model number
- 2) Wood species and finish, see page 4
- 3) Pull style and finish, see page 74
- 4) Edge profile, see page 73

*Indicates model illustrated by line drawing.

CODE DESCRIPTION

- 0 — no pedestal
- 4 — full height pedestal
- D — 2 file drawers
- F — 2 box, 1 file drawer
- L — left-hand pedestal position
- R — right-hand pedestal position
- X — includes a modesty panel

WIRING GROMMETS

One rectangular grommet in a standard position is optional at no charge. Additional rectangular grommets are available at an upcharge of \$100 list.

LOCKS

Locks are standard on all pedestals and lateral file drawers.

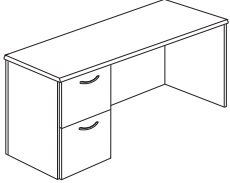
Description	Model	Rift Oak	Cherry Maple	W	D	H	KW	Shipping Weight	Cubic Feet
Single pedestal credenza full modesty panel continued 	97C-7820-4-XLDRO	2302	2424	77.75	20	29.5	61	168	35.5
	XLORD								
	XLFR0								
	XLORF								
	97C-7824-4-XLDRO	2309	2431	77.75	24	29.5	61	176	41.5
	XLORD								
	XLFR0								
	XLORF								
	97C-8420-4-XLDRO	2314	2436	83.75	20	29.5	67	184	38
	XLORD								
	XLFR0								
	XLORF								
97C-8424-4-XLDRO	2321	2443	83.75	24	29.5	67	192	44.5	
XLORD									
XLFR0									
XLORF									

ORDERING NOTES

For legal sized file drawers, please add LG - before '97' in model number and add \$50 list per pedestal. Widths above reflect letter size file drawers.

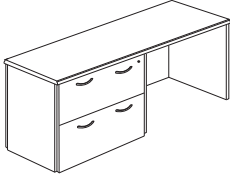
Single pedestal credenza lateral file or bookcase full modesty panel 	97C-7220-XLBRO	2121	2232	71.75	20	29.5	36	128	33
	XLORB	2121	2232					128	
	XLFR0*	2398	2525					168	
	XLORF	2398	2525					168	
	97C-7224-XLBRO	2200	2315	71.75	24	29.5	36	136	38.5
	XLORB	2200	2315					136	
	XLFR0	2437	2566					176	
	XLORF	2437	2566					176	
	97C-8420-XLBRO	2184	2307	83.75	20	29.5	48	181	38
	XLORB	2184	2307					181	
	XLFR0	2554	2699					221	
	XLORF	2554	2699					221	
	97C-8424-XLBRO	2235	2379	83.75	24	29.5	48	212	44.5
	XLORB	2235	2379					212	
	XLFR0	2616	2771					252	
	XLORF	2616	2771					252	

DIMENSION KEY

W — width
 D — depth
 H — height of worksurface
 KW — kneehole width

Dimensions are in inches and approximate.
 Contact Customer Service if dimensions are critical.

*Indicates model illustrated by line drawing.

CODE DESCRIPTION

0 — no pedestal
 4 — full height pedestal
 B — bookcase
 D — 2 file drawers
 F — when preceded in the model number by -4:
 2 box, 1 file drawer — when it directly follows the size classifier:
 2 lateral file drawers
 L — left-hand pedestal position
 R — right-hand pedestal position
 X — includes a modesty panel

STANDARD FINISHES

For a complete list of standard wood finishes please see page 4.

WIRE MANAGEMENT CUT-OUTS

A wire management cut-out is available on full modesty panels. Note clearly on Purchase Order and add \$150 list upcharge.

EFFECTIVE MARCH 1, 2008 A PRICE INCREASE OF 5% WILL APPLY TO ALL PRODUCTS IN THIS PRICE LIST

CREDENZAS

EFFECTIVE MARCH 1, 2008 A PRICE INCREASE OF 5% WILL APPLY TO ALL PRODUCTS IN THIS PRICE LIST

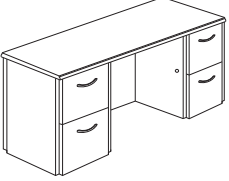
Description	Model	Rift Oak	Cherry Maple	W	D	H	KW	Shipping Weight	Cubic Feet
Double pedestal kneehole credenza full modesty panel 	97C-6020-4-XLDRD	2393	2518	59.75	20	29.5	28.25	200	28
	XLDRF								
	XLFRD								
	XLFRF								
	97C-6024-4-XLDRD	2411	2538	59.75	24	29.5	28.25	208	32.5
	XLDRF								
	XLFRD								
	XLFRF								
	97C-6620-4-XLDRD	2429	2556	65.75	20	29.5	34.25	216	30.5
	XLDRF								
	XLFRD								
	XLFRF								
	97C-6624-4-XLDRD	2434	2562	65.75	24	29.5	34.25	224	35.5
	XLDRF								
	XLFRD								
	XLFRF								
97C-7220-4-XLDRD	2452	2581	71.75	20	29.5	40.25	232	33	
XLDRF									
XLFRD									
XLFRF									
97C-7224-4-XLDRD*	2473	2603	71.75	24	29.5	40.25	240	38.5	
XLDRF									
XLFRD									
XLFRF									
97C-7820-4-XLDRD	2475	2605	77.75	20	29.5	46.25	248	35.5	
XLDRF									
XLFRD									
XLFRF									
97C-7824-4-XLDRD	2478	2609	77.75	24	29.5	46.25	256	41.5	
XLDRF									
XLFRD									
XLFRF									
97C-8420-4-XLDRD	2481	2612	83.75	20	29.5	52.25	264	38	
XLDRF									
XLFRD									
XLFRF									
97C-8424-4-XLDRD	2492	2622	83.75	24	29.5	52.25	272	44.5	
XLDRF									
XLFRD									
XLFRF									

ORDERING PROCEDURE

To order, please specify the following:

- 1) Krug product model number
- 2) Wood species and finish, see page 4
- 3) Pull style and finish, see page 74
- 4) Edge profile, see page 73

*Indicates model illustrated by line drawing.

CODE DESCRIPTION

- 4 — full height pedestal
- D — 2 file drawers
- F — 2 box, 1 file drawer
- L — left-hand pedestal position
- R — right-hand pedestal position
- X — includes a modesty panel

WIRING GROMMETS

One rectangular grommet in a standard position is optional at no charge. Additional rectangular grommets are available at an upcharge of \$100 list.

LOCKS

Locks are standard on all pedestals and lateral file drawers.

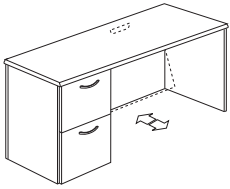
Description	Model	Rift Oak	Cherry Maple	W	D	H	KW	Shipping Weight	Cubic Feet
 <p>Single pedestal credenza hinged modesty panel</p>	97CY-6020-4-LDRO	2448	2577	59.75	20	29.5	43	120	28
	LORD								
	LFRO								
	LORF								
	97CY-6024-4-LDRO	2466	2596	59.75	24	29.5	43	128	32.5
	LORD								
	LFRO								
	LORF								
	97CY-6620-4-LDRO*	2486	2617	65.75	20	29.5	49	136	30.5
	LORD								
	LFRO								
	LORF								
	97CY-6624-4-LDRO	2498	2630	65.75	24	29.5	49	144	35.5
	LORD								
	LFRO								
	LORF								
	97CY-7220-4-LDRO	2509	2641	71.75	20	29.5	55	152	33
	LORD								
	LFRO								
	LORF								
	97CY-7224-4-LDRO	2530	2663	71.75	24	29.5	55	160	38.5
	LORD								
	LFRO								
	LORF								
97CY-7820-4-LDRO	2533	2666	77.75	20	29.5	61	168	35.5	
LORD									
LFRO									
LORF									
97CY-7824-4-LDRO	2541	2675	77.75	24	29.5	61	176	41.5	
LORD									
LFRO									
LORF									
97CY-8420-4-LDRO	2545	2679	83.75	20	29.5	67	184	38	
LORD									
LFRO									
LORF									
97CY-8424-4-LDRO	2553	2687	83.75	24	29.5	67	192	44.5	
LORD									
LFRO									
LORF									

DIMENSION KEY

- W — width
- D — depth
- H — height of worksurface
- KW — kneehole width

Dimensions are in inches and approximate.
Contact Customer Service if dimensions are critical.

*Indicates model illustrated by line drawing.

CODE DESCRIPTION

- 0 — no pedestal
- 4 — full height pedestal
- D — 2 file drawers
- F — 2 box, 1 file drawer
- L — left-hand pedestal position
- R — right-hand pedestal position
- Y — hinged modesty panel

STANDARD FINISHES

For a complete list of standard wood finishes please see page 4.

HINGED MODESTY PANELS

Hinged modesty panels come standard with a wire management cut-out.

EFFECTIVE MARCH 1, 2008 A PRICE INCREASE OF 5% WILL APPLY TO ALL PRODUCTS IN THIS PRICE LIST

CREDENZAS

EFFECTIVE MARCH 1, 2008 A PRICE INCREASE OF 5% WILL APPLY TO ALL PRODUCTS IN THIS PRICE LIST

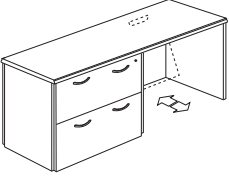
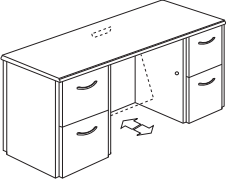
Description	Model	Rift Oak	Cherry Maple	W	D	H	KW	Shipping Weight	Cubic Feet
Single pedestal credenza lateral file or bookcase hinged modesty panel 	97CY-7220-LBRO	2333	2456	71.75	20	29.5	36	128	33
	LORB	2333	2456					128	
	LFRO*	2637	2776					168	
	LORF	2637	2776					168	
	97CY-7224-LBRO	2419	2547	71.75	24	29.5	36	136	38.5
	LORB	2419	2547					136	
	LFRO	2680	2821					176	
	LORF	2680	2821					176	
Double pedestal kneehole credenza hinged modesty panel 	97CY-6020-4-LDRD	2633	2771	59.75	20	29.5	28.75	200	28
	LDRF								
	LFRD								
	LFRF								
	97CY-6024-4-LDRD	2652	2792	59.75	24	29.5	28.25	208	32.5
	LDRF								
	LFRD								
	LFRF								
	97CY-6620-4-LDRD	2672	2812	65.75	20	29.5	34.25	216	30.5
	LDRF								
	LFRD								
	LFRF								
	97CY-6624-4-LDRD	2677	2818	65.75	24	29.5	34.25	224	35.5
	LDRF								
	LFRD								
	LFRF								
	97CY-7220-4-LDRD	2698	2840	71.75	20	29.5	40.25	232	33
	LDRF								
	LFRD								
	LFRF								
97CY-7224-4-LDRD*	2720	2863	71.75	24	29.5	40.25	240	38.5	
LDRF									
LFRD									
LFRF									
97CY-7820-4-LDRD	2723	2866	77.75	20	29.5	46.25	248	35.5	
LDRF									
LFRD									
LFRF									

ORDERING PROCEDURE

To order, please specify the following:

- 1) Krug product model number
- 2) Wood species and finish, see page 4
- 3) Pull style and finish, see page 74
- 4) Edge profile, see page 73

*Indicates model illustrated by line drawing.

CODE DESCRIPTION

- 4 — full height pedestal
- D — 2 file drawers
- F — when preceded in the model number by -4:
2 box, 1 file drawer
- when it directly follows the size classifier:
2 lateral file drawers
- L — left-hand pedestal position
- R — right-hand pedestal position
- Y — hinged modesty panel

WIRING GROMMETS

One rectangular grommet in a standard position is optional at no charge. Additional rectangular grommets are available at an upcharge of \$100 list.

LOCKS

Locks are standard on all pedestals and lateral file drawers.

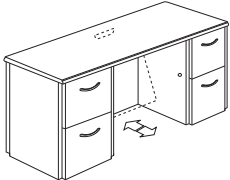
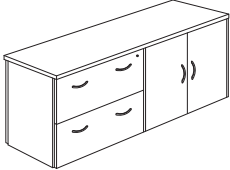
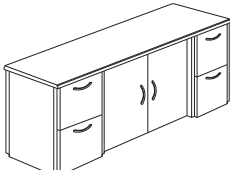
Description	Model	Finish		W	D	H	KW	Shipping Weight	Cubic Feet
		Rift Oak	Cherry Maple						
Double pedestal kneehole credenza hinged modesty panel continued 	97CY-7824-4-LDRD	2726	2870	77.75	24	29.5	46.25	256	41.5
	LDRF								
	LFRD								
	LFRF								
	97CY-8420-4-LDRD	2731	2874	83.75	20	29.5	52.25	264	38
	LDRF								
	LFRD								
	LFRF								
	97CY-8424-4-LDRD	2739	2883	83.75	24	29.5	52.25	272	44.5
LDRF									
LFRD									
LFRF									
Lateral file/bookcase full face credenza 	97C-7220-LBRB	2583	2719	71.75	20	29.5	-	208	33
	LBRF	3034	3194					228	
	LFRB*	3034	3194					228	
	LFRF	3325	3500					248	
	97C-7224-LBRB	2617	2755	71.75	24	29.5	-	224	38.5
	LBRF	3090	3253					236	
	LFRB	3090	3253					236	
	LFRF	3368	3545					256	
Full face storage credenza 	97C-6624-DBCD	3025	3185	65.75	24	29.5	-	242	35.5
	97C-7224-DBCD*	3169	3336	71.75	24	29.5	-	256	38.5
	97C-8424-DBCD	3298	3472	77.75	24	29.5	-	271	44.5

ORDERING NOTES

For legal sized file drawers, please add LG - before '97' in model number and add \$50 list per pedestal.
Widths above reflect letter size file drawers.

DIMENSION KEY

- W — width
- D — depth
- H — height of worksurface

Dimensions are in inches and approximate.
Contact Customer Service if dimensions are critical.

*Indicates model illustrated by line drawing.

CODE DESCRIPTION

- 4 — full height pedestal
- BC — bookcase
- D — 2 file drawers
- F — 2 box, 1 file drawer
- L — left-hand pedestal position
- R — right-hand pedestal position
- Y — hinged modesty panel

STANDARD FINISHES

For a complete list of standard wood finishes please see page 4.

HINGED MODESTY PANELS

Hinged modesty panels come standard with a wire management cut-out.

EFFECTIVE MARCH 1, 2008 A PRICE INCREASE OF 5% WILL APPLY TO ALL PRODUCTS IN THIS PRICE LIST

CREDENZAS

EFFECTIVE MARCH 1, 2008 A PRICE INCREASE OF 5% WILL APPLY TO ALL PRODUCTS IN THIS PRICE LIST

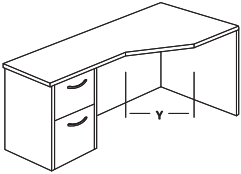
Description	Model	Rift Oak	Cherry Maple	W	D	H	KW	Y	Shipping Weight	Cubic Feet
Corner credenza single pedestal 	97CC-7220-XL4D*	1948	2050	71.75	20/32	29.5	32	21	184	49.5
	XL4F									
	XR4D									
	XR4F									
	97CC-7224-XL4D	1987	2091	71.75	24/36	29.5	32	21	192	55.5
	XL4F									
	XR4D									
	XR4F									
	97CC-8420-XL4D	2010	2116	83.75	20/30	29.5	44	21	200	57
	XL4F									
	XR4D									
	XR4F									
97CC-8424-XL4D	2029	2136	83.75	24/36	29.5	44	21	208	64	
XL4F										
XR4D										
XR4F										

ORDERING NOTES

Corner Credenzas accept 24" deep run-off units.

For legal sized file drawers, please add LG - before '97' in model number and add \$50 list per pedestal.

Widths above reflect letter size file drawers.

ORDERING PROCEDURE

To order, please specify the following:

- 1) Krug product model number
- 2) Wood species and finish, see page 4
- 3) Pull style and finish, see page 74
- 4) Edge profile, see page 73

*Indicates model illustrated by line drawing.

CODE DESCRIPTION

- 4 — full height pedestal
- B — bookcase
- D — 2 file drawers
- F — when preceded in the model number by -4:
2 box, 1 file drawer
- when it directly follows the size classifier:
2 lateral file drawers
- L — left-hand pedestal position
- R — right-hand pedestal position
- X — includes a modesty panel

STANDARD FINISHES

For a complete list of standard wood finishes please see page 4.

CORNER CREDENZAS AND KEYBOARDS

When ordering a keyboard for use with corner credenza, please specify, see page 117.

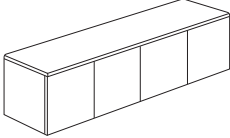
Description	Model	Rift		W	D	H	Door	Shipping Weight	Cubic Feet
		Oak	Cherry Maple						
 Overhead wood doors	970H-3615	965	1016	36	14.75	16	2	53	8
	970H-4215	1024	1077	42	14.75	16	2	57	9
	970H-4815	1063	1119	48	14.75	16	3	77	10
	970H-6015	1249	1315	59.75	14.75	16	4	88	12.5
	970H-6615	1317	1386	65.75	14.75	16	4	94	13.5
	970H-7215*	1385	1458	71.75	14.75	16	4	99	15

Tackboards for use with overheads

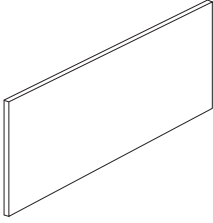
		FABRIC GRADES									W	H	COM	WT
		1	2	3	4	5	6	7	8	9				
	97TB0H-36	212	236	260	297	387	474	560	651	765	35.75	23.25	1	10
	97TB0H-42	236	318	337	418	503	580	665	766	904	41.75	23.25	2	11
	97TB0H-48	263	327	342	430	515	591	682	784	943	47.75	23.25	2	12
	97TB0H-60	298	399	418	521	626	742	858	975	1159	59.5	23.25	2	14
	97TB0H-66	327	445	476	581	696	827	941	1075	1280	65.75	23.25	2	15
	97TB0H-72	359	550	574	761	935	947	1087	1240	1446	71.5	23.25	2	17

ORDERING NOTES

Krug panel fabrics are recommended at grade 1 pricing. See page 6 for information.
Only Krug panel fabric tackboards are available on *KrugExpress*.

DIMENSION KEY

W — width
 D — depth
 H — height of unit

Dimensions are in inches and approximate.
 Contact Customer Service if dimensions are critical.

*Indicates model illustrated by line drawing.

CODE DESCRIPTION

TB — tackboard

TACKBOARDS

See page 6 for fabric options for tackboards.

OVERHEADS

All overheads include installed tasklights and mounting hardware.

HUTCHES

EFFECTIVE MARCH 1, 2008 A PRICE INCREASE OF 5% WILL APPLY TO ALL PRODUCTS IN THIS PRICE LIST

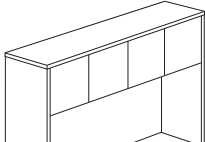
Description	Model	Rift Oak	Cherry Maple	W	D	H	CH	Shipping Weight	Cubic Feet
	97HT-6015-40	1740	1831	59.75	14.75	39.25	23.25	117	23.5
	97HT-6615-40	1933	2035	65.75	14.75	39.25	23.25	126	25.5
	97HT-7215-40*	2210	2327	71.75	14.75	39.25	23.25	135	28
	97HT-7815-40	2381	2507	77.75	14.75	39.25	23.25	146	30
	97HT-8415-40	2553	2687	83.75	14.75	39.25	23.25	154	32.5
	97HT-9615-40	3702	3896	95.5	14.75	39.25	23.25	211	38.5

ORDERING NOTES

Hutches come standard with Krug panel grade 1 fabric. See page 6 for color options.

Voice/Power/Data modules can be specified by placing a 'W' at the end of the hutch model number and applying a \$120 list upcharge.

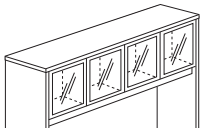
Description	Model	Rift Oak	Cherry Maple	W	D	H	CH	Shipping Weight	Cubic Feet
	97HT-6015-40G	1948	2051	59.75	14.75	39.25	23.25	117	23.5
	97HT-6615-40G	2165	2279	65.75	14.75	39.25	23.25	126	25.5
	97HT-7215-40G*	2475	2605	71.75	14.75	39.25	23.25	135	28
	97HT-7815-40G	2668	2808	77.75	14.75	39.25	23.25	146	30
	97HT-8415-40G	2859	3010	83.75	14.75	39.25	23.25	154	32.5
	97HT-9615-40G	4146	4364	95.5	14.75	39.25	23.25	222	38.5

ORDERING NOTES

Hutches come standard with a Krug panel grade 1 fabric. See page 6 for color options.

Voice/Power/Data modules can be specified by placing a 'W' at the end of the hutch model number and applying a \$120 list upcharge.

ORDERING PROCEDURE

To order, please specify the following:

- 1) Krug product model number
- 2) Wood species and finish, see page 4
- 3) Pull style and finish, see page 74
- 4) Edge profile, see page 73

*Indicates model illustrated by line drawing.

CODE DESCRIPTION

- G — wood framed frosted glass doors
- W — power/data/voice module

LOCKS

Locks are optional on all wood doors at an upcharge of \$100 list per set of (2) doors. Locks are not available on wood framed frosted glass doors.

HUTCHES

Hutches over 84" in length will be made in two pieces.

Description	Model	Rift		W	D	H	CH	Shipping Weight	Cubic Feet
		Oak	Cherry Maple						
5-hi hutch paper manager 	97HTPM-6615-40	2382	2508	65.75	14.75	39.25	20.25	181	25.5
	97HTPM-7215-40*	2723	2866	71.75	14.75	39.25	20.25	194	28
	97HTPM-7815-40	2767	2912	77.75	14.75	39.25	20.25	207	30
	97HTPM-8415-40	2809	2957	83.75	14.75	39.25	20.25	220	32.5
	97HTPM-9615-40	4074	4288	95.5	14.75	39.25	20.25	260	38.5

ORDERING NOTES

Hutches come standard with a Krug panel grade 1 fabric. See page 6 for information.

Voice/Power/Data modules can be specified by placing a 'W' at the end of the hutch model number and applying a \$120 list upcharge.

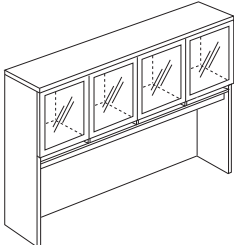
5-hi hutch paper manager glass doors 	97HTPM-6615-40G	2669	2809	65.75	14.75	39.25	20.25	186	25.5
	97HTPM-7215-40G*	3050	3211	71.75	14.75	39.25	20.25	199	28
	97HTPM-7815-40G	3098	3261	77.25	14.75	39.25	20.25	212	30
	97HTPM-8415-40G	3147	3312	83	14.75	39.25	20.25	225	23.5
	97HTPM-9615-40G	4563	4803	95.5	14.75	39.25	20.25	265	38.5

ORDERING NOTES

Hutches come standard with a Krug panel grade 1 fabric. See page 6 for information.

Voice/Power/Data modules can be specified by placing a 'W' at the end of the hutch model number and applying a \$120 list upcharge.

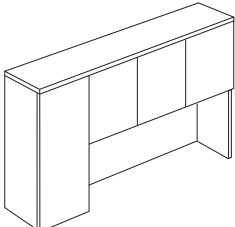
5-hi hutch single wood door pier 	97HTPR-6615-40-L110HR0 L00HR11	2320	2442	65.75	14.75	39.25	23.25	183	25.5
	97HTPR-7215-40-L110HR0* L00HR11	2652	2791	71.75	14.75	39.25	23.25	196	28
	97HTPR-7815-40-L110HR0 L00HR11	2858	3009	77.75	14.75	39.25	23.25	215	30
	97HTPR-8415-40-L110HR0 L00HR11	3063	3225	83.75	14.75	39.25	23.25	221	32.5
	97HTPR-9615-40-L110HR0 L00HR11	4442	4676	95.5	14.75	39.25	23.25	245	50.5

ORDERING NOTES

Hutches come standard with a Krug panel grade 1 fabric. See page 6 for information.

Voice/Power/Data modules can be specified by placing a 'W' at the end of the hutch model number and applying a \$120 list upcharge.

DIMENSION KEY

- W — width
- D — depth
- H — height of unit
- CH — clearance height from worksurfaces

Dimensions are in inches and approximate.
Contact Customer Service if dimensions are critical.

*Indicates model illustrated by line drawing.

CODE DESCRIPTION

- G — wood framed frosted glass doors
- 11 — wood door pier
- W — power/data/voice module

STANDARD FINISHES

For a complete list of standard wood finishes please see page 4.

KRUG EXPRESS

Only Krug panel fabrics are available on *KrugExpress*.

HUTCHES

EFFECTIVE MARCH 1, 2008 A PRICE INCREASE OF 5% WILL APPLY TO ALL PRODUCTS IN THIS PRICE LIST

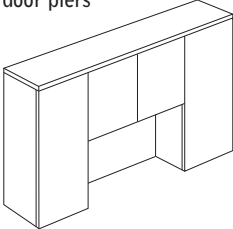
Description	Model	Rift Oak	Cherry Maple	W	D	H	CH	Shipping Weight	Cubic Feet
5-hi hutch left and right wood door piers 	97HTPR-6615-40-L110HR11	2551	2685	65.75	14.75	39.25	23.25	197	25.5
	97HTPR-7215-40-L110HR11*	2917	3070	71.75	14.75	39.25	23.25	210	28
	97HTPR-7815-40-L110HR11	3144	3309	77.75	14.75	39.25	23.25	223	30
	97HTPR-8415-40-L110HR11	3370	3547	83.75	14.75	39.25	23.25	236	32.5
	97HTPR-9615-40-L110HR11	4887	5145	95.5	14.75	39.25	23.25	261	50.5

ORDERING NOTES

Hutches come standard with a Krug panel grade 1 fabric. See page 6 for information.

Voice/Power/Data modules can be specified by placing a 'W' at the end of the hutch model number and applying a \$120 list upcharge.

Tackboard upcharges for standard hutches

All hutches include a tackboard in Krug panel grade 1 fabric. Use this chart to find the upcharge for tackboard fabrics graded 2-9 and add it to the cost of the hutch. Grading information can be found on page 6 of the price guide.

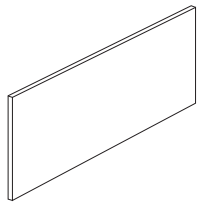

		FABRIC GRADES									
		2	3	4	5	6	7	8	9	COM	
60"	hutch tackboard*	104	221	324	432	537	639	743	926	1	
66"	hutch tackboard	115	250	367	490	609	725	842	1045	2.25	
72"	hutch tackboard	139	298	437	587	728	868	1008	1213	2.25	
78"	hutch tackboard	164	350	516	684	848	1014	1179	1407	2.5	
84"	hutch tackboard	195	406	603	797	993	1187	1381	1632	2.75	
96"	hutch tackboard	241	501	744	984	1225	1467	1705	1979	3	
66"	single pier door hutch tackboard	104	221	324	432	537	639	743	903	2	
72"	single pier door hutch tackboard	104	221	324	432	537	639	743	903	2	
78"	single pier door hutch tackboard	104	221	324	432	537	639	743	903	2.25	
84"	single pier door hutch tackboard	115	250	367	490	609	725	842	1045	2.75	
96"	single pier door hutch tackboard	195	406	603	797	993	1187	1353	1634	2.75	
66"	double pier door hutch tackboard	104	221	324	432	537	639	743	903	1.25	
72"	double pier door hutch tackboard	104	221	324	432	537	639	743	903	1.5	
78"	double pier door hutch tackboard	104	221	324	432	537	639	743	903	1.75	
84"	double pier door hutch tackboard	104	221	324	432	537	639	743	903	2	
96"	double pier door hutch tackboard	115	250	367	490	609	725	842	1045	2.25	

ORDERING NOTES

Only Krug panel fabrics are available on *KrugExpress*.

ORDERING PROCEDURE

To order, please specify the following:

- 1) Krug product model number
- 2) Wood species and finish, see page 4
- 3) Pull style and finish, see page 74
- 4) Edge profile, see page 73

*Indicates model illustrated by line drawing.

CODE DESCRIPTION

11 — wood door pier

LOCKS

Locks are optional on all wood doors at an upcharge of \$100 list per set of (2) doors. Locks are not available on wood framed frosted glass doors.

HUTCHES

Hutches over 84" in length will be made in two pieces.

TACKBOARD YARDAGE

See page 19 for the COM yardage calculation chart for tackboards.

Description	Model	Rift	Cherry	W	D	H	Shipping Weight	Cubic Feet
		Oak	Maple					
Paper manager *	97PM-171220-02*	740	779	17	12.5	19.75	50	3.5
	97PM-171220-03	740	779	17	12.5	19.75	50	3.5

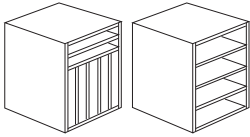

2 box, 1 file pedestal	97P-1618-4F*	1125	1183	15.75	18	28	61	6.5
	97P-1628-4F	1311	1380	15.75	27.5	28	72	10

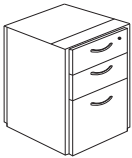

ORDERING NOTES

For legal sized file drawers, please add LG - before '97' in model number and add \$50 list per pedestal. Widths above reflect letter size file drawers.

2 file pedestal	97P-1618-4D*	990	1042	15.75	18	28	59	6.5
	97P-1628-4D	1155	1215	15.75	27.5	28	70	10

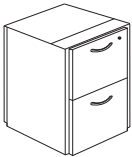

ORDERING NOTES

For legal sized file drawers, please add LG - before '97' in model number and add \$50 list per pedestal. Widths above reflect letter size file drawers.

Bookcase pedestal	97PBC-3020*	1118	1176	29.75	20	28	108	12
-------------------	-------------	------	------	-------	----	----	-----	----

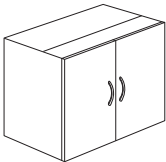

Lateral file pedestal	97PLF-3020	1319	1388	29.75	18	28	104	12
	97PLF-3620*	1385	1458	35.75	18	28	112	14

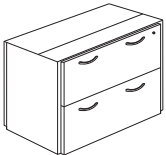

DIMENSION KEY

W — width
D — depth
H — height of unit

Dimensions are in inches and approximate.
Contact Customer Service if dimensions are critical.

*Indicates model illustrated by line drawing.

CODE DESCRIPTION

4 — full height pedestal
BC — bookcase
D — 2 file drawers
F — 2 box, 1 file drawer
LF — lateral file
PM — paper manager

STANDARD FINISHES

For a complete list of standard wood finishes please see page 4.

PEDESTALS

Pedestal tops and backs are unfinished.

LOCKS

Locks on bookcase pedestal doors are available at \$100 list. Please specify a time of order. All other pedestals include a standard lock.

PEDESTALS | MEETING TABLES

EFFECTIVE MARCH 1, 2008 A PRICE INCREASE OF 5% WILL APPLY TO ALL PRODUCTS IN THIS PRICE LIST

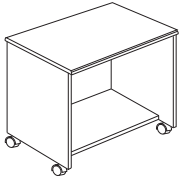
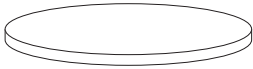
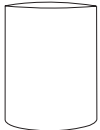
Description	Model	Rift Oak	Cherry Maple	W	D	H	Shipping Weight	Cubic Feet
 Mobile pedestal	97MP-162028-4F	1139	1199	15.75	20	27.75	110	6.5
 Mobile computer cart	97THC-362129	1950	2053	35.75	20	29	105	16.6
 Round meeting table	9705-36	921	969	36	36	1.25	50	3
	9705-42	1071	1128	42	42	1.25	62	4.1
	9705-48	1172	1234	48	48	1.25	80	5.33
 Drum base	9710-18D29	497	523	-	18 dia	28.75	97	3.5

ORDERING PROCEDURE

To order, please specify the following:

- 1) Krug product model number
- 2) Wood species and finish, see page 4
- 3) Pull style and finish, see page 74
- 4) Edge profile, see page 73

*Indicates model illustrated by line drawing.

CODE DESCRIPTION

MP — mobile pedestal

LOCKS

Locks on bookcase pedestal doors are available at \$100 list. Please specify a time of order. All other pedestals include a standard lock.

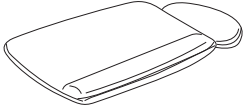
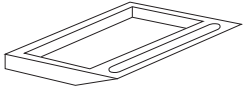
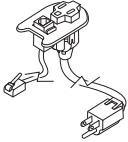
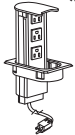
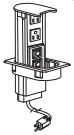
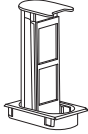
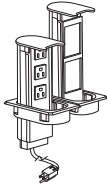
Description	Model	Price	W	D	H	Shipping Weight	Cubic Feet
Keyboard tray with palm rest, mouse tray & extended articulating mechanism 	97KBAMT	438	27	11 to 29.5	1 to 10	20	2
ORDERING NOTES This unit comes with a lever-free arm keyboard support. This unit is granite in color. Order for 24" tops or deeper.							
Pencil drawer 	97PD-2116	386	21	16	1	2	1
ORDERING NOTES Please specify wood finish.							
Power and telephone grommet 	97PDSM	166	3	2	-	1	1
ORDERING NOTES The power and telephone grommet has a RJ11 coupler for telephone use. RJ45 data couplers are available, please specify at time of order.							
Pop-up power center  	97PUPC* 97PUPD**	220	4	2.5	8.5	1	1
ORDERING NOTES If ordering pop-up grommets for field installation, please note clearly on purchase order.							
Pop-up communication housing 	97PUCH	109	4	2.5	8.5	1	1
ORDERING NOTES If ordering pop-up grommets for field installation, please note clearly on purchase order.							
Pop-up center and communication housing 	97PUDG	294	4	5.25	8.5	1	1
ORDERING NOTES If ordering pop-up grommets for field installation, please note clearly on purchase order.							

DIMENSION KEY

W — width
 D — depth
 H — height of worksurface
 KW — kneehole width

Dimensions are in inches and approximate.
 Contact Customer Service if dimensions are critical.

*Indicates model illustrated by line drawing.

CODE DESCRIPTION

KBAMT — keyboard drawer with mouse tray
 PD — pencil drawer
 PDSM — power and telephone grommet
 PUCH — pop-up communication housing
 PUDG — pop-up center and communication housing
 PUPC — pop-up power/data center
 PUPD — pop-up power/data center
 WM — wire management

STANDARD FINISHES

For a complete list of standard wood finishes please see page 4.

WIRING GROMMETS

One rectangular grommet in a standard position is optional at no charge. Additional rectangular grommets are available at an upcharge of \$100 list.

EFFECTIVE MARCH 1, 2008 A PRICE INCREASE OF 5% WILL APPLY TO ALL PRODUCTS IN THIS PRICE LIST

WIRE MANAGEMENT

EFFECTIVE MARCH 1, 2008 A PRICE INCREASE OF 5% WILL APPLY TO ALL PRODUCTS IN THIS PRICE LIST

Description	Model	Price	W	D	H	Shipping Weight	Cubic Feet
Wire management cover 	97WM72	99	72	2.5	1	3	7
Velcro wire management cover 	97WM4	29	3.5	1.75	-	1	1

ORDERING PROCEDURE

To order, please specify the following:

- 1) Krug product model number
- 2) Wood species and finish, see page 4
- 3) Pull style and finish, see page 74
- 4) Edge profile, see page 73

*Indicates model illustrated by line drawing.

CODE DESCRIPTION

WM — wire management

WIRING GROMMETS

One rectangular grommet in a standard position is optional at no charge. Additional rectangular grommets are available at an upcharge of \$100 list.

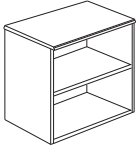
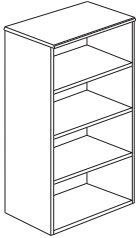
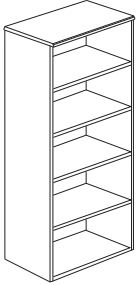
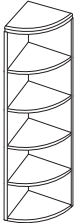
Description	Model	Rift Oak	Cherry Maple	W	D	H	Shipping Weight	Cubic Feet
2-hi open bookcase 	97BC-301629*	1033	1088	30	15.75	29.5	48	10
	97BC-361629	1061	1117	36	15.75	29.5	56	12
4-hi open bookcase 	97BC-301666*	1319	1388	30	15.75	55.5	64	18
	97BC-361666	1347	1418	36	15.75	55.5	72	21.5
5-hi open bookcase 	97BC-301669*	1429	1504	30	15.75	69.5	100	22
	97BC-361669	1458	1536	36	15.75	69.5	112	27
Open corner bookcase 	97STCE-2020-2917L R	1429	1504	20	20	29.5	56	8
	97STCE-2424-2917L R	1495	1573	24	24	29.5	65	11.5
	97STCE-2020-6917L* R	1786	1880	20	20	69.5	130	19
	97STCE-2424-6917L R	1867	1965	24	24	69.5	138	27

DIMENSION KEY

W — width
D — depth
H — height of unit

Dimensions are in inches and approximate.
Contact Customer Service if dimensions are critical.

*Indicates model illustrated by line drawing.

CODE DESCRIPTION

BC — bookcase

STANDARD FINISHES

For a complete list of standard wood finishes please see page 4.

BOOKCASES

Bookcases do not have finished backs. 5-hi bookcases require fastening to a wall for safety.

STORAGE

EFFECTIVE MARCH 1, 2008 A PRICE INCREASE OF 5% WILL APPLY TO ALL PRODUCTS IN THIS PRICE LIST

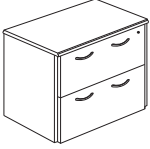
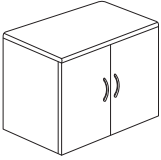
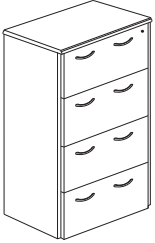
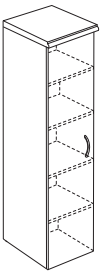
Description	Model	Rift Oak	Cherry Maple	W	D	H	Shipping Weight	Cubic Feet
2-hi lateral file 	97ST-362029-01	1739	1830	36	20	29.5	116	15
	97ST-362429-01	1762	1855	36	24	29.5	120	18
2-hi closed bookcase 	97ST-362029-11	1321	1392	36	20	29.5	104	15
	97ST-362429-11	1346	1417	36	24	29.5	108	18
4-hi lateral file 	97ST-362055-01	2387	2512	36	20	55.5	176	25.5
	97ST-362455-01	2540	2674	36	24	55.5	196	30.5
5-hi single door closed shelves 	97ST-192469-11L* R	1671	1758	18.75	24	69.5	132	21.5

ORDERING PROCEDURE

To order, please specify the following:

- 1) Krug product model number
- 2) Wood species and finish, see page 4
- 3) Pull style and finish, see page 74
- 4) Edge profile, see page 73

*Indicates model illustrated by line drawing.

CODE DESCRIPTION

- L — door hinged left
- R — door hinged right
- ST — storage unit

LOCKS

Locks are optional on all wood doors at an upcharge of \$100 list per set of (2) doors. Locks are not available on wood framed frosted glass doors.

EFFECTIVE MARCH 1, 2008 A PRICE INCREASE OF 5% WILL APPLY TO ALL PRODUCTS IN THIS PRICE LIST

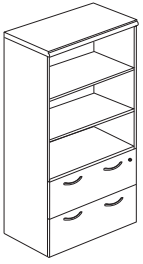
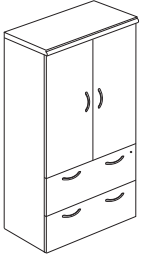
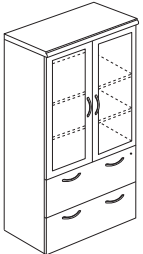
Description	Model	Rift	Cherry	W	D	H	Shipping Weight	Cubic Feet
		Oak	Maple					
5-hi 2 lateral, 3 open 	97ST-362069-03	2604	2741	36	20	69.5	180	33
	97ST-362469-03	2635	2774	36	24	69.5	188	40
5-hi 2 lateral, 3 closed 	97ST-362069-04	2907	3059	36	20	69.5	192	33
	97ST-362469-04	2940	3094	36	24	69.5	200	40
5-hi 2 lateral, 3 closed glass 	97ST-362069-04G*	3081	3242	36	20	69.5	192	33
	97ST-362469-04G	3116	3280	36	24	69.5	200	40

DIMENSION KEY

- W — width
- D — depth
- H — height of unit

Dimensions are in inches and approximate.
Contact Customer Service if dimensions are critical.

*Indicates model illustrated by line drawing.

CODE DESCRIPTION

- ST — storage unit

STANDARD FINISHES

For a complete list of standard wood finishes please see page 4.

STORAGE

EFFECTIVE MARCH 1, 2008 A PRICE INCREASE OF 5% WILL APPLY TO ALL PRODUCTS IN THIS PRICE LIST

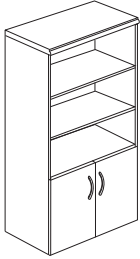
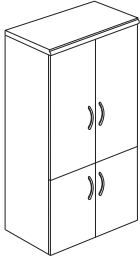
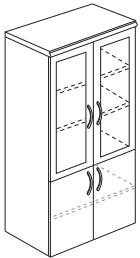
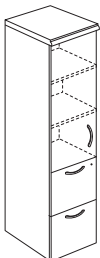
Description	Model	Rift Oak	Cherry Maple	W	D	H	Shipping Weight	Cubic Feet
5-hi 2 closed, 3 open 	97ST-362069-13*	2083	2192	36	20	69.5	104	33
	97ST-362469-13	2108	2220	36	24	69.5	116	40
5-hi 2 closed, 3 closed 	97ST-362069-14*	2403	2530	36	20	69.5	184	33
	97ST-362469-14	2437	2565	36	24	69.5	192	40
5-hi 2 closed, 3 closed glass 	97ST-362069-14G*	2691	2834	36	20	69.5	184	33
	97ST-362469-14G	2730	2873	36	24	69.5	192	40
5-hi 2 file, 3 closed 	97ST-192069-91L R	2403	2530	18.75	20	69.5	123	18
	97ST-192469-91L* R	2437	2565	18.75	24	69.5	132	21.5

ORDERING PROCEDURE

To order, please specify the following:

- 1) Krug product model number
- 2) Wood species and finish, see page 4
- 3) Pull style and finish, see page 74
- 4) Edge profile, see page 73

*Indicates model illustrated by line drawing.

CODE DESCRIPTION

- ST — storage unit
- L — door hinged left
- R — door hinged right
- G — wood framed frosted glass doors

LOCKS

Locks are optional on all wood doors at an upcharge of \$100 list per set of (2) doors. Locks are not available on wood framed frosted glass doors.

Description	Model	Rift Oak	Cherry Maple	W	D	H	Shipping Weight	Cubic Feet
5-hi wardrobe	97WR-192469-02L* R	1441	1517	18.75	24	69.5	138	21.5

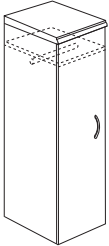

5-hi 2 file, 3 closed	97WR-192469-22L* R	1729	1820	18.75	24	69.5	138	21.5
-----------------------	-----------------------	------	------	-------	----	------	-----	------



5-hi wardrobe, 5 closed	97WR-362469-01 03*	2178	2293	36	24	69.5	164	40
-------------------------	-----------------------	------	------	----	----	------	-----	----

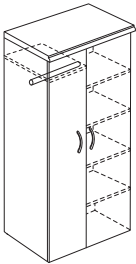

ORDERING NOTES

- (01) Indicates closed left shelves and closed right wardrobe.
- (03) Indicates closed right shelves and closed left wardrobe.

DIMENSION KEY

- W — width
- D — depth
- H — height of unit

Dimensions are in inches and approximate.
Contact Customer Service if dimensions are critical.

*Indicates model illustrated by line drawing.

CODE DESCRIPTION

- L — door hinged left
- R — door hinged right
- WR — wardrobe

STANDARD FINISHES

For a complete list of standard wood finishes please see page 4.

EFFECTIVE MARCH 1, 2008 A PRICE INCREASE OF 5% WILL APPLY TO ALL PRODUCTS IN THIS PRICE LIST

WARDROBES | AV CABINETS

EFFECTIVE MARCH 1, 2008 A PRICE INCREASE OF 5% WILL APPLY TO ALL PRODUCTS IN THIS PRICE LIST

Description	Model	Rift Oak	Cherry Maple	W	D	H	Shipping Weight	Cubic Feet
5-hi wardrobe, 5 closed	97WR-302469-18 19*	2178	2293	29.5	24	69.5	164	31.5

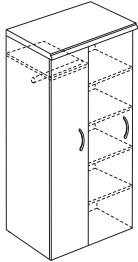

ORDERING NOTES

(18) Indicates closed left shelves, closed right wardrobe.
 (19) Indicates closed right shelves, closed left wardrobe.
 Closed shelves are center hinged.

Audio visual - upper pocket doors	97AV-362469-02	3255	3426	36	24	69.5	180	40
--------------------------------------	----------------	------	------	----	----	------	-----	----

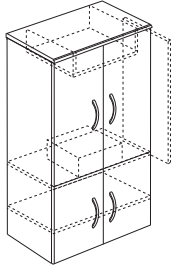

ORDERING NOTES

This item is not available on *KrugExpress*.

ORDERING PROCEDURE

To order, please specify the following:

- 1) Krug product model number
- 2) Wood species and finish, see page 4
- 3) Pull style and finish, see page 74
- 4) Edge profile, see page 73

*Indicates model illustrated by line drawing.

CODE DESCRIPTION

WR — wardrobe
 AV — audio visual cabinet

LOCKS

Locks on bookcase doors are available at \$100 list.
 Please specify at time of order.

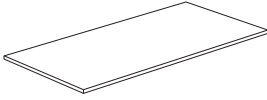
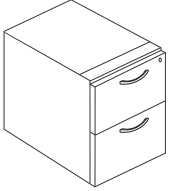
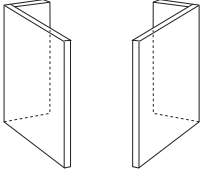
Description	Model	Rift Oak	Cherry Maple	W	D	H	Shipping Weight	Cubic Feet
Tops 	97TP-4820	443	474	47.75	20	1.25	30	2.25
	97TP-4824	470	494	47.75	24	1.25	37	2.75
	97TP-4830	484	515	47.75	30	1.25	44	3.25
	97TP-5420	489	520	53.75	20	1.25	34	2.5
	97TP-5424	501	527	53.75	24	1.25	42	3
	97TP-5430	510	541	53.75	30	1.25	52	3.75
	97TP-6020	567	597	59.75	20	1.25	39	2.75
	97TP-6024	596	627	59.75	24	1.25	46	3.25
	97TP-6030	618	649	59.75	30	1.25	56	4
	97TP-6620	721	762	65.75	20	1.25	43	3
	97TP-6624	746	785	65.75	24	1.25	50	3.5
	97TP-6630	773	809	65.75	30	1.25	64	4.5
	97TP-7220	824	876	71.75	20	1.25	44	3.25
	97TP-7224*	852	896	71.75	24	1.25	55	4
	97TP-7230	876	922	71.75	30	1.25	65	4.75
	97TP-7820	927	968	77.25	20	1.25	49	3.5
	97TP-7824	947	996	77.25	24	1.25	59	4.25
	97TP-7830	979	1020	77.25	30	1.25	73	5.25
	97TP-8420	1025	1082	83.75	20	1.25	52	3.75
	97TP-8424	1050	1105	83.75	24	1.25	63	4.5
97TP-8430	1082	1128	83.75	30	1.25	77	5.5	
Pedestals 	97P-1620-4F	1082	1143	15.75	20	29.5	55	6.25
	97P-1620-4D	953	1015	15.75	20	29.5	55	6.25
	97P-1624-4F	1160	1221	15.75	24	29.5	66	7.5
	97P-1624-4D*	1022	1075	15.75	24	29.5	66	7.5
	97P-1630-4F	1231	1298	15.75	30	29.5	101	11.5
	97P-1630-4D	1092	1154	15.75	30	29.5	101	11.5
L support 	97LB-2029L	433	464	16	20	29.5	55	2.25
	97LB-2029R	433	464	16	20	29.5	55	2.25
	97LB-2429L	460	485	16	24	29.5	60	3
	97LB-2429R	460	485	16	24	29.5	60	3
	97LB-3029L	489	510	16	30	29.5	70	3.5
	97LB-3029R	489	510	16	30	29.5	70	3.5

DIMENSION KEY

W — width
D — depth
H — height of unit

Dimensions are in inches and approximate.
Contact Customer Service if dimensions are critical.

*Indicates model illustrated by line drawing.

CODE DESCRIPTION

4 — full height pedestal
D — 2 file drawers
F — 2 box, 1 file drawers
L — left L support
R — right L support

STANDARD FINISHES

For a complete list of standard wood finishes please see page 4.

OPEN SPANS

Modular units with an open span greater than 48" require the support of a half gable.

EFFECTIVE MARCH 1, 2008 A PRICE INCREASE OF 5% WILL APPLY TO ALL PRODUCTS IN THIS PRICE LIST

MODULAR TOPS | PEDESTALS | BASES

EFFECTIVE MARCH 1, 2008 A PRICE INCREASE OF 5% WILL APPLY TO ALL PRODUCTS IN THIS PRICE LIST

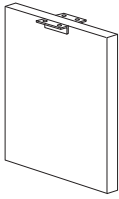
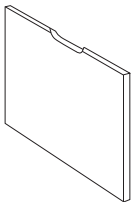
Description	Model	Rift Oak	Cherry Maple	W	D	H	Shipping Weight	Cubic Feet
Half gable	97HG-2029	251	265	19.75	-	27.25	18	1
								
Hinged modesty panel	97MPY-32-X41	383	404	32	24	29.5	19	2.25
	97MPY-38-X41	391	412	38	24	29.5	22	3.25
	97MPY-44-X41	400	420	44	24	29.5	26	3.75
	97MPY-50-X41	408	430	50	24	29.5	29	4
	97MPY-56-X41	426	449	56	24	29.5	32	4.5
	97MPY-62-X41	435	457	62	24	29.5	35	5
	97MPY-68-X41	443	467	68	24	29.5	38	5.5
								

ORDERING PROCEDURE

To order, please specify the following:

- 1) Krug product model number
- 2) Wood species and finish, see page 4
- 3) Pull style and finish, see page 74
- 4) Edge profile, see page 73

*Indicates model illustrated by line drawing.

CODE DESCRIPTION

- X41 — full height modesty panel
- Y — hinged modesty panel

STANDARD FINISHES

For a complete list of standard wood finishes please see page 4.

OPEN SPANS

Modular units with an open span greater the 48" require the support of a half gable.

I N D E X

2	General Information
4	Wood Finishes
5	Laminates
6	Fabrics & Leather
7	Customer's Own Material
8	Krug Express
9	Guidelines & Pricing Methods

YORKVILLE

Product Specification Guide

12	General Product Specifications
13	Edge Detail Profiles
14	Grain Direction, Pulls & Locks
15	Grommets
17	Desks & Credenzas
18	Linking Units, Corner Units, Hutches, Overheads & Tackboards
19	Tasklights & Installation
20	Filing Instructions
21	Installation
23	Suggested Configurations

Product List

25	Desks
29	Curvilinear Desks
33	Returns
38	Curvilinear Returns
40	Linking Units
41	Corner Units
42	Credenzas
49	Overheads
50	Hutches
55	Paper Managers
56	Pedestals
57	Meeting Tables
58	Keyboards, Pencil Drawers & Grommets
60	Accessories
61	Bookcases, Storage & Wardrobes
70	AV Cabinets

CONTOUR

Product Specification Guide

72	General Product Specifications
73	Edge Detail Profiles
74	Bookcases, Grain Direction, Pulls & Locks
75	Grommets
77	Laminate Worksurfaces
78	Credenzas, Linking Units & Corner Units
79	Hutches, Overheads, Tackboards & Tasklights
80	Filing Instructions
81	Installation
83	Suggested Configurations

Product List

85	Desks
88	Curvilinear Desks
92	Returns
98	Curvilinear Returns
101	Linking Units
102	Corner Units
103	Credenzas
111	Overheads
112	Hutches
115	Paper Managers & Modular Pedestals
117	Keyboards, Pencil Drawers & Wiring Grommets
119	Bookcases, Storage & Wardrobes
126	Modular Components