

**CASEGOODS**  
Price and Specification Guide  
**CANADA**



Effective March 1, 2019

**krug**

May 2019

# CASEGOODS | TABLE OF CONTENTS

2	General Information
4	Krug Textiles
5	Graded-in Upholstery Program
5	Express Program
5	Tackboard Fabric
6	Laminates
7	Adesso
108	Vestrada
236	Millennium
309	Artemis
426	Artemis Laminate
499	Latitude
555	Stratford

# GENERAL INFORMATION

## TERMS AND CONDITIONS

Net 30 days on approved credit. A late payment charge of 1% per month will be applied on overdue invoices. This charge will be pro-rated to the number of days past 30 days that the invoice is overdue. All applicable sales taxes are extra. Prices include shipping to territorial warehouse. Distribution of this price list does not in itself constitute an offer to sell. Orders can be received only from authorized Krug dealers. Acceptance of any order and terms of sale may be established at the discretion of Krug. Deposits are required on orders received from new accounts as well as on large or special orders. Krug reserves the right to discontinue designs, or to change designs, construction, prices, or materials without notice.

## CUSTOMER SERVICE HOURS

Please note customer service hours are:  
8:30 am to 5:00 pm est  
1.888.578.KRUG  
1.519.748.5177 fax

## ORDER ACKNOWLEDGEMENTS

Each order will be acknowledged via email or fax. This acknowledgement is the final agreement between Krug and the customer, superseding all previous communications regarding the purchase order. Where there is a discrepancy on a purchase order between a product code and a description, Krug will make every effort to resolve the discrepancy, but will be ruled by the product code ordered. Please check all acknowledgements for accuracy and advise Krug of any discrepancies with a purchase order.

## CANCELLATION

A cancellation can be made only by expressed agreement with Krug. A cancellation fee may be incurred for restocking.

## DIMENSIONS

Dimensions are in inches and approximate, and subject to change without notice. Contact Customer Service if dimensions are critical.

## STORAGE CHARGES

Krug reserves the right to assess a nominal storage charge if a customer does not accept shipment of an order within a week of the ship date.

## CONTACT INFORMATION

Phone: 1.888.578.KRUG  
Fax: 1.519.748.5177  
Purchase Order Fax: 1.888.236.4783 or email: orders@krug.ca  
Web: www.krug.ca  
Email: solutions@krug.ca

## INSTALLATION SUPPORT

For assistance please contact Technical Support at 1-888-578-5784 x216 or e-mail installationhelp@krug.ca and you will be directed to the appropriate installation support person.

## PRICING

Krug endeavors to ensure that all prices in this price list reflect accurately our current prices. However, errors do occur and will be rectified through notices to the field. Krug's website will always have the current list price. Krug reserves the right to acknowledge pricing that may be different from the price list.

## WARRANTY

Krug warrants its products to be free from defects in materials and workmanship for a period of 10 years from the date of purchase. This warranty is applicable to products in use by their original purchaser. This warranty does not apply to components and materials not manufactured by Krug; these are subject to the specific warranties of their manufacturers (if any). Repairs or replacement of any defect covered under this warranty by Krug will be made, at our option and method, at no charge to the original purchaser. Krug's judgement is final and binding with respect to the nature or cause of defects or damage, and the necessity or manner of repair or replacement.

## Height Adjustable Mechanism Warranty

Krug warrants to the original consumer purchaser its height adjustable mechanism that it will be free from defects in material and workmanship. This limited warranty covers material and manufacturing defects, which cause a non-conformance in the function of a table base and is limited to the following products and warranty term determined from their dates of purchase:

- a) Electronic components such as control boxes, hand switches and motors – two (2) years
- b) Mechanical components such as crank drives, spindles – five (5) years; and

- c) Structural components such as J-channels, feet and top supports – ten (10) years. The start of the warranty period is the documented date of your purchase of the product. The warranty herein is made to and for the benefit of the original consumer purchaser of the product and is non-transferable. If you discover a defect in material or workmanship during the warranty period, and Krug agrees that the defect exists, Krug will, at its option, repair or replace the Product at no charge to you, provided it is returned during the warranty period. In the unlikely event that your product should require repair or replacement during the warranty period, please contact Krug to obtain warranty service.

The warranty period on replacement Products is the remainder of the warranty on the original product or 30 days, whichever is longer. This warranty does not apply to defects or damage resulting from:

- normal wear and tear occurring with the use of the product
- negligence, misuse, excessive use, alteration, improper cleaning or repair
- substitution or use of incorrect or unauthorized components or material
- handling or installation that is incorrect, or that causes damage or defect
- damage incurred by a freight carrier other than Krug
- wearing of finishes and fabrics, and normal variations in materials (including dye lot variations)
- properties of natural materials, including wood and leather
- exposure to environments with uncontrolled temperature and humidity (products must be transported, stored and used in climate-controlled conditions)

## EXPORT PACKAGING

Krug is pleased to provide the option for export packaging on all our products, to provide additional protection from damage. Export packaging is provided at an upcharge of 5% of the net selling price per item. Export Packaging is **STRONGLY RECOMMENDED** for:

- (A) all shipments outside of the lower 48 states and Canada
- (B) all shipments that will be held in storage for an extended period prior to installation.

Important: Please note that Krug will not be responsible for damage claims on product shipped or stored in the above conditions but where export packaging has not been utilized.

Please contact Customer Service for specifications or any other assistance regarding export packaging.

## FREIGHT TERMS AND CONDITIONS

1. All product is shipped FOB the Krug factory. Freight is either pre-paid to the destination (dealer's dock or territorial warehouse, where available) or not pre-paid, depending on established customer specific freight terms.

2. Docks at the selected delivery location must be equipped to handle a 53' trailer. If dock is inadequate for delivery by Krug, Krug will re-deliver to another location and any additional costs will be charged to the customer.

3. When a Krug territorial warehouse (where available) is selected as the default delivery location, Krug pays freight cost to the territorial warehouse only, and no further. The Customer is responsible for all charges from this point.

4. For all deliveries, it is understood that Krug or its agent is making a dock delivery only (equipped to handle a 53' trailer), and any further work of truck unloading, delivery beyond the dock, installation, and removal of packaging is not authorized or paid for by Krug.

5. Drop shipments to the installation site, and timed deliveries, are available on larger shipments (full truckloads or slightly less) at no additional charge. Drop shipments or timed deliveries for smaller shipments may not be available, or if available will require a surcharge. Deliveries on an after hours basis, or on weekends, or any other special requirements, may be subject to a surcharge. Location and contact information, and the requested time of delivery, are required at least one week prior to the acknowledged shipment date. If this information is not provided one week in advance, or if the location or time of the drop shipment is changed less than one week in advance, a surcharge may be applied, and/or the drop shipment may not be scheduled. For deliveries requested Monday to Thursday after 5:00 pm, please apply a surcharge of \$250/shipment. For deliveries requested Monday to Friday before 7:00 am, please apply a surcharge of \$250/shipment. For deliveries requested Friday (after 3:00 pm) or weekends, please apply a surcharge of \$500/shipment. (local times).

6. For all deliveries - whether to the Customer location or drop shipment - any circumstances that result in the delay of our carrier (including unsuitable receiving facilities, or facilities not open or available), service charges will be applied at the rate of \$75/hour. Where re-delivery is necessary because of these circumstances, the full cost re-delivery will be charged. If Less Than Truck Load is delivering, one hour is allocated to unload. Any additional time required to unload after the first hour is \$75/hour. If a Truck Load is delivering the order, three hours is allocated to unload. Any additional time required to unload is \$75/hour. Direct deliveries to site for net orders are possible, must exceed \$60,000 net, and accommodate 48-53' trailers. Krug is responsible for delivery to the approved delivery address. If an address change is required, this must be authorized by Krug 5 business days prior to ship date. Any additional delivery costs incurred after this time will be charged to the customer.

## CUSTOMER SATISFACTION

It is the primary goal of Krug and our staff to ensure the complete satisfaction of our customers with our products and performance. If a problem arises with a Krug product after the expiration of the limited warranty period, Krug will exercise its best efforts to achieve the satisfaction of the customer in a manner that is fair to all concerned.

## DAMAGED SHIPMENTS

All Krug product is well engineered, carefully inspected, and expertly loaded onto our trucks at our Distribution Center. If you receive any damaged freight, we ask that you do not refuse the shipment. Krug is not responsible for damage to goods that occurs in transit or storage. It is the purchaser and/or receiver's responsibility to examine the goods upon receipt and to notify Krug of any damages, overages or shortages. Any discrepancies should be noted on the Bill of Lading. The delivering carrier will not accept responsibility for shortages or damages if signed "clear". Notification of concealed damage claims must be made to Krug Distribution within 5 days of delivery, along with digital pictures if available. All product and packaging must be available for inspection. Krug liability ceases after 5 business days and Krug will not be responsible for concealed damages if shipments are left unopened. Krug is not responsible for the condition of product that is stored or installed in an environment where temperature and humidity are not controlled. Products must be opened and inspected on receipt, and any products not inspected when received, or held in storage, cannot be subjected to damage claims.

## TESTING

All Krug Casegoods products meet or exceed the testing requirements of ANSI/BIFMA X5.5-2014 and/or X5.9 - 2012.



## FIELD PRODUCT REPORT AUTHORIZATION

Krug's written authorization, in the form of an FPR number, must be obtained prior to incurring charges of any kind if Krug is expected to pay these charges. This includes authorization for field repairs and replacements, installation and delivery charges. Krug reserves the right to have its representative inspect product related to any request for such authorizations, prior to that authorization being provided. Deductions from invoices paid for any charges to Krug, without prior written authorization in the form of an FPR, will not be accepted. Digital photographs may be required to complete the FPR process.

## RETURNS

No merchandise may be returned without Krug's prior written consent. In the event of an authorized return, a Field Product Report (FPR) number will be issued, and a restocking charge will apply. Return transportation charges must be prepaid. Unauthorized returns will not be accepted and will be returned freight collect. All merchandise being returned must be properly packaged in its original or comparable replacement packaging to ensure protection of the product during handling and transportation. Returns on orders duplicated by the customer must be received in their original packaging to be accepted. Product being returned where Krug has authorized its liability for replacement or repair will be thoroughly inspected on its return, and the results compared to the reason for the return stated on the FPR. Any discrepancies, such as additional damage, signs of usage, missing parts, etc., will result in an adjustment to the amount of credit issued.

## CARE AND MAINTENANCE

### WOOD FINISH

Although Krug's extensive finishing process ensures a durable finish on all our products, there are several steps that can be taken to protect and prolong the life and beauty of the finish. Protect the top by placing felt pads on the bottom of any accessories and mechanical equipment. Rubber and oil will permanently mark surfaces. Use a desk pad to prevent possible damage and imprinting caused by writing instruments and sharp objects.

Dust only with a clean, dry cloth, going with the grain. Clean any marks with a damp cloth, using a small quantity of mild soap or detergent. Do not use any wax-based polish, spray or silicone. Eventually, a film will build up and discolor the top. Do not place your furniture in a position of permanent exposure to direct sunlight.

### LAMINATES

Clean plastic laminate surfaces with mild soap and warm water. Do not use steel wool, hot water, or any abrasive cleaning product.

### PAINTED GLASS

To clean simply wipe with an ammonia based cleaner using a microfibre cloth. Do not use a coarse cloth or an abrasive cleaning products on painted surfaces to avoid scratching.

### FABRIC UPHOLSTERY

Professional upholstery cleaning is recommended.

### CUSTOM CAPABILITIES

Over 15% of our orders involve some type of custom work, and we invite our customers to make use of our extensive capabilities.

These include:

- 1) Dimensional customization of standard size products.
  - 2) Custom finishes
  - 3) For larger orders, completely custom designed products, as well as non-standard wood species can be specified.
- Custom orders will require additional production lead times. Contact Customer Service for more information.

## Krug Textiles - Fabric Program

Krug Grade 1, 2 and 3 fabrics are also available on a cut yardage basis.

### Grade 1

Perk	Vox	Fuse	Expo
Auburn	Bark	Azurean	Festive
Cabana	Black	Carmine	Fog
Cedar	Cocoa	Cress	Latte
Crimson	Downpour	Ginger	Leaf
Dijon	Eco	Iris	Lemon
Ebony	Frothe	Lunar	Oasis
Flint	Goldenrod	Malted	Raspberry
Patriot	Honest	Morel	Sky
Pewter	Hot	Pepper	Spirit
Regal	Limelight	Pimento	Sprout
Sesame	Morel	Pristine	Tuxedo
Walnut	Mystic	Saffron	Viola
	Navy	Walnut	Zest
	Oat		
	Par		
	Ruby		
	Snap		
	Turquoise		

### Grade 2

Epic	Knack	Bangle	Lineup
Azure	Berry	Baltic	Baltic
Capri	Brisk	Cork	Fern
Espresso	Carbon	Granite	Pewter
Flare	Dark Roast	Orchid	Sandstone
Granite	Filament	Sable	Shadow
Jute	Fresco	Suede	Spice
Kiwi	Glaze	Teak	Tranquil
Limestone	Reed		
Pearl	Sax		
Porcini	Teak		
Regal	Wave		
Slice	Zest		
Steel	Zing		

### Grade 3

Solace	Current	Clang	Kinney
Almond	Birch	Amber	Coffee
Azul	Cadet	Claret	Frappe
Blaze	Eclipse	Clove	Glacier
Carmine	Espresso	Cress	Mineral
Celadon	Moss	Flint	Nectar
Cinder	Pecan	Malt	Steel
Earth	Plum	Raven	Valentine
Ebony			
Fossil			
Gilded			
Indigo			
Ivory			
Mineral			
Pear			
Peony			

### Krug Textiles - Cut fabric per yard

Grade 1	\$53
Grade 2	\$63
Grade 3	\$73

**Krug Textiles - Leather Program**

**Grade 8**

Black	K13.1000	Graphite	K13.4000
Stone	K13.3000	Espresso	K13.8000
Sand	K13.5000	White	K13.9000

Please contact Customer Service for specific information on leathers, available colors and lead times.

**Krug Textiles - Faux Leather Program**

**Grade 2**

White	Taupe	Bisque	Wine	Sprig	Lagoon
Cream	Mocha	Chocolate	Garnet	Chinchilla	Pacific Blue
Parchment	Tan	Black	Rust	Steel	Navy
Sandstone	Chestnut	Earth	Citron	Grey	Plum
Vanilla		Brick			

**GRADED-IN UPHOLSTERY PROGRAMS**

Krug has partnered with several textile brands to grade in their offerings, designed to provide a wide range of upholstery selections for our seating products.

Upholstery pricing and availability is subject to change without notice. We grade this upholstery according to the pricing of the fabric suppliers - when their pricing changes, the Krug grade may change. When placing an order, a Krug customer must specify the complete upholstery number, along with the appropriate Krug model number and finish. Krug will supply the complete product at the prices listed. Orders specifying graded-in upholstery cannot be cancelled once the upholstery has been ordered.

**Upholstery Grades**

To determine the price of a product for graded-in upholstery, use the reference lists located on Krug’s website under - Products - Textiles, to view the upholstery grade (1-9). Krug is not responsible for the discontinuation of this upholstery. Please contact Customer Service for information on upholstery not listed.

When two upholstery selections are specified for use on seating, the higher grade upholstery price will apply to the order.

High Performance upholstery; Polyurethane, Vinyl or Crypton, is particularly suitable for healthcare and other intensive-use environments.

**Upholstery Samples**

If you require additional samples or memos for presentation, please contact fabric supplier directly.

**Flammability Standards**

- Tunnel Test Surface Ratings Class A rating
- Class 1 UFAC
- Passes State of California Technical Bulletin CAL 117-2013

Please contact fabric supplier directly for further flammability information pertaining to specific upholstery.

**Special Conditions**

Acknowledgements will give the estimated delivery date of the finished product. Some upholstery is imported, and availability may affect estimated delivery time. For large projects, please contact fabric supplier directly for availability of yardage.

**TACKBOARD FABRICS**

**KRUG PANEL FABRIC PROGRAM**

Tackboards can be upholstered in COM material supplied by the customer, and in a selection of stocked tackboard fabrics supplied by Momentum. The in-stock Momentum fabrics are priced at Grade 1 and are available on Krug Express. They are 100% polyester. For additional information and color selections, please refer to our Panel Fabrics card and Krug’s website. [www.krug.ca](http://www.krug.ca) If memo samples are required please call Momentum at 1-800-366-6839. The Momentum panel fabrics pass ASTM-E84-87 Fire Codes.

**PROGRAM DETAILS**

KrugExpress orders are ready to ship by the date acknowledged. Delivery and shipping schedules may result in actual shipping of orders at a later date. Statutory holidays and scheduled factory vacations may add to acknowledged lead times of KrugExpress orders. Unless otherwise specified on the order, the customer’s standard method of shipping Krug products will be utilized. Available factory capacity for KrugExpress is filled by orders received on a “first come, first serve” basis. If the normal KrugExpress lead time is not available for your order because available capacity has been filled, you will be immediately advised of the earliest available ready-to-ship date. Please consult your Customer Service representative in advance if you wish to confirm the specific lead time availability for a KrugExpress order. Orders must be received by midnight of a given day for that day to be considered the official day the order is received. Order lead times are acknowledged from the date the order is received, but not including the date the order is received. KrugExpress orders must be “clean” when received in order to be considered officially received on a given day, and lead times will be acknowledged from the date orders are determined to be “clean”. Changes to KrugExpress orders are not allowed under any

circumstances. Orders for product on KrugExpress must clearly state: “KrugExpress”. \*Some conditions apply. Please note PALETTE finishes are not available on KrugExpress.

**CASEGOODS PROGRAM**

Orders for casegood products on the KrugExpress program may be subject to quantity maximums. Please contact Krug Customer Service for more information. Quantity maximums are dependent upon available capacity, in order to insure that we ship all orders on time. Only actual casegood pieces and conference tables tops and bases are considered “units”. Items such as tasklights, tackboards, keyboard trays and drawers, electrical and wire management components, etc., are not considered under the quantity restrictions. For example, a typical office configuration that includes a desk, linking unit, credenza and hutch/overhead, equals a total of four units for the purposes of the quantity maximum. Only Krug In-stock panel fabric is available on the KrugExpress program. Only standard wood finishes are available for KrugExpress orders. Grommets can be specified in standard positions only. KrugExpress also includes all Krug seating and occasional tables as well as Krug conference products to complement this casegoods offering.

# CUSTOMER'S OWN MATERIAL - C.O.M.

## Customer's Own Material (COM)

**COM must be received three weeks prior to the acknowledged ship date. Orders with COM not received by the required deadline will be delayed.**

A description of the fabric, including supplier name, fabric name and color number must be included with the purchase order. When the COM fabric is received at Krug, it must be clearly identified with the fabric name and color, and tagged with name of the Krug customer and purchase order number. Krug will inspect all COM fabric when received to determine if it will be suitable for upholstery. Where Krug feels that the fabric or leather specified will compromise the quality or integrity of our products, customers will be contacted to direct these concerns. Further, Krug reserves the right to refuse to accept and use any COM fabrics or leathers that will compromise our products in any way that is unacceptable to Krug. Krug cannot assume responsibility for the durability or tailoring quality of customer's own material.

Yardage specified in this price guide is approximate. In the case of multiple product orders, multiply the number of items by the COM yardage specified to determine fabric required, unless otherwise indicated. Additional yardage may be needed if the material is less than 54" wide, or patterned or striped and requires matching. As fabric is applied horizontally, non-directional fabrics are recommended. COM fabrics are applied as they come off the roll unless otherwise specified. All striped fabrics will be applied vertically unless otherwise stated by the customer and after approval by Krug. It is the customer's responsibility to advise Krug if the upholstery is to be applied otherwise, and to advise Krug of any special upholstery instructions. Special instructions should be sent to Krug Customer Service, including a sample (or photocopy) of the fabric. Krug is not responsible for instructions sent with the fabric rolls, or for the method of upholstery if no instructions have been provided. COM fabrics for tackboards may be specified in either Maharam or Momentum panel fabrics. Krug is not responsible for determining if a fabric is not ideal for tackboard application.

Please contact Maharam at 1-800-645-3943 or Momentum at

## COM Shipping Procedures

**For tackboard COM fabrics, please send fabrics to:**

**Krug Inc.**

**111 Ahrens Street**

**Kitchener, Ontario**

**Canada N2H 4C2**

**Attention: RECEIVER**

All packages must be clearly marked "For Customs Clearance by Willson International Custom Brokers". According to the North American Free Trade Agreement (NAFTA), goods shipped between the United States and Canada can qualify for exemption from all duties, or for a reduction in duties, if the goods can be proven to originate in either the United States, Canada or Mexico.

Canada Customs requires that a NAFTA Certificate of Origin and Commercial Invoice be completed and sent with the fabric shipment. The Commercial Invoice must clearly state the description of the fabric, the selling price, the make-up or content, and the purchaser. The absence of these two documents will delay the shipments at the U.S./Canada border, thereby potentially delaying the customer order. If the total value of the shipment is less than \$1200 U.S., Customs will accept a Low Value Statement of Origin in place of the NAFTA Certificate of Origin. The Low Value Statement must be signed by a representative of the exporting company. This statement may either be included on the commercial invoice or attached to the invoice.

Krug is happy to answer any questions or concerns about COM shipping procedures and the required documents. Please contact our Customs Specialist at 1.888.578.5784.

# LAMINATES

## LAMINATES

Krug's in-stock Laminates are available in 17 different laminate selections. Please note that 4 of the colors (Gingerbread, Portobello, Ash and Willow) have textured finishes and may not be appropriate for use in patient areas due to infection control concerns. Minimum order quantities and extended lead times may apply for exotic laminate colors, please check with customer service. Polymer Edge will be selected to match the worksurface. Krug's previous laminate in-stock program will be phased out as in-stock supply depletes. Please contact customer service for availability.

## IN-STOCK LAMINATES

Wood Grain Laminates	High Pressure Laminate Supplier	Textured Wood Grain Laminates	High Pressure Laminate Supplier
Champagne	Tafisa T492CR	Gingerbread	Tafisa T556UR
Hardrock Maple	Formica 86992-58	Portobello	Tafisa T557UR
Dune	Tafisa T491CR	Ash	Tafisa T535AT
Copper	Tafisa T521CR	Willow	Tafisa T543AT
Shiraz Cherry	Tafisa T472CR	<b>Solid Laminates</b>	
Park Avenue Walnut	Wilsonart 7984-38	Designer White	Wilsonart D354-60
Chocolate	Tafisa T498CR	Platinum	Tafisa T202CR
Nutmeg	Tafisa T477CR	Earth	Tafisa T767CR
Dark Walnut	Tafisa T469CR	Charcoal	Tafisa T228CR

## PHASE OUT LAMINATES

Mocha Cherry - Almond - Black- Shadows - Edgewood Sycamore - Gunstock Walnut

## Non-Stocked Laminates

For specific lead time and application questions, please contact Krug Customer Service for your requirement. Upcharges will be applicable for non-stocked laminates, depending on their cost. Non-stock laminates may require a minimum order quantity, please contact customer service. Stocked polymer edges only can be specified for use with non-stocked laminates or tops will be self-edged.

# STRATFORD | TABLE OF CONTENTS

556 LEED CI Credit Summary
556 level® Certification, Air Emissions and FSC Certificati
557 General Product Specification
558 Finishes
558 Edge Detail Profile
559 Profiles & Overhang
562 Drawer Pulls & Lock
563 Grommets
564 Laminate Worksurfaces
565 Non-Standard Product Guidelines for Pricing
566 Desk Specification
566 Credenza Specification
567 Overhead & Hutch Specification
568 Installation
569 Sample Configuration
570 Desks
574 Returns
576 Linking Units
576 Corner Units
577 Credenzas
581 Overheads
581 Overhead Tackboards
582 Hutches
584 Hutch Tackboard Upcharges
585 Keyboard Tray & Cable Management
586 Modular Components
596 Bookcases
597 Storage
601 Reception



LEED CI - Credit Summary

## STRATFORD CASEGOODS



### MATERIAL CONTENT:

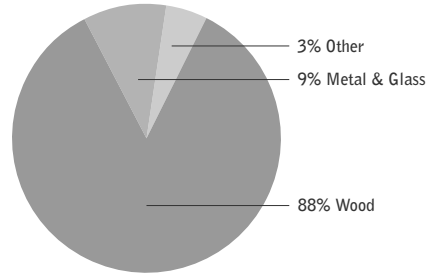

PRE-CONSUMER  
RECYCLED CONTENT = 77%

POST-CONSUMER  
RECYCLE CONTENT = 2.5%

### CONTRIBUTES TO

CREDIT 2.1 - 2.2	Construction Waste Management	1-2 point(s)
CREDIT 3.3	Resource Reuse	1 point(s)
CREDIT 4.1	Recycled Content	1 point(s)
CREDIT 4.2	Recycled Content	1 point(s)
CREDIT 4.4	Low Emitting Materials, (PLEASE ENQUIRE) Composite Wood & Laminate Adhesives	1 point(s)
CREDIT 5.1	Regional Materials*	1 point(s)
CREDIT 7	Certified Wood (PLEASE ENQUIRE)	1 point(s)

\* This credit is only applicable if in total 20% of the combined value of the procurement of construction materials and in the furniture are manufactured within a radius of 500 miles. This credit will apply if the installation of the finished product occurs within 500 miles of Toronto, Ontario.

## level® CERTIFICATION, AIR EMISSIONS AND FSC® CERTIFICATION



### level® Certification

BIFMA's e3 Furniture Sustainability Standard is a voluntary, multi-attribute standard that measures the degree of sustainability of furniture. This standard evaluates product and company environmental attributes and compliance systems in a wide range of elements which include Materials, Energy & Atmosphere, Human & Ecosystem Health and Social Responsibility. Stratford products have earned level®, BIFMA's sustainability certification program for furniture, certification through third-party verification against the e3 standard.



The mark of responsible forestry

### Air Emissions

All Stratford products can be supplied with air emissions-certification. Contact customer service for information and upcharges.

### FSC®

In 2005, Krug received Forest Stewardship Council® (FSC®) Chain-of-Custody certification for our manufacturing facilities. The FSC® Chain-of-Custody tracks certified wood from seedling to final sale. It signifies that the growth, harvesting and production of goods are entirely achieved through responsible forestry, which guarantees a healthy supply of forest resources for generations to come. Stratford and other Krug products can be specified with one of two types of FSC® Certification:

- (a) FSC®-certified (which includes FSC®-certified lumber, veneer and substrate material)
  - (b) FSC®-mix certified (which includes substrate material only, and is a lower cost option certification)
- Both FSC® certification types may require upcharges, and often require additional lead time. Contact customer service for further information, pricing and leadtimes.



In addition, architects, designers, and building professionals can specify FSC®-certified products in order to achieve a point from the U.S. Green Building Council's Leadership in Energy and Environmental Design (LEED) Rating System.

# STRATFORD | GENERAL PRODUCT SPECIFICATIONS

## WORKSURFACES

Tops are made of 1 1/4" - 42 lbs. per cubic foot density particle board core with face and back veneers. All edges have 1 1/8" wide 1" thick solid Cherry or Walnut headers.

## DRAWER FRONTS AND DOORS

48 lbs. per cubic foot density Medium Density Fiberboard with face and back veneer.

## GABLES

Gables are 3/4" or 1 1/8" thick - 45 lbs. per cubic foot density particleboard core, 3 ply. Edges are banded with veneer. Bottom edges of 1 1/8" gables are banded with polyvinyl chloride edge banding.

## VENEER

External face veneers are flat sliced Black Walnut or Cherry bookmatched and of uniform color and grain pattern.

## SOLIDS

All solids used shall be American Black Walnut or Cherry kiln-dried by the manufacturer to a 6% moisture content, using U.S.D.A. Bulletin #FP-1136.

## FINISH

All surfaces to be finished are well sanded before applying finish materials. The procedure begins with the application of a base color via a Non-Grain Raising stain. Next a wash coat is applied to seal the NGR stain and ensure an even colored finish. The a filler coat is applied and hand wiped to fill the open pores in the wood surface and further enhance the depth color. A sealer is applied and scuff sanded to prepare the surfaces for the top coat (finish). The final procedure is to apply a coat of 52° sheen catalyzed varnish to protect the surfaces and add luster.

## LOCKS

Locks are standard on all pedestals and storage unit lateral file drawers.  
Locks are optional on door fronts and must be specified at time of order.  
Locks are not available on glass doors.

## DRAWERS

Box drawers have ball bearing movement, full extension slides with urethane cushioned stops and hold-in catch. Box drawers have a load bearing capacity of 100 lbs. per drawer. File drawers have progressive action ball bearing full-extension slides with urethane cushioned stops and hold-in catch. File drawers have a load bearing capacity of 100 lbs. per drawer. Lateral file drawers have full-extension slides with over-travel ball movement slides with urethane cushioned stops. Lateral file drawers have a load bearing capacity of 150 lbs. per drawer. All drawer slides allow for easy removal of the drawers. All drawer interiors are birch veneer. All file drawers are equipped for letter and legal filing. All desks with the center drawer option include a matching pencil tray in the center drawer. All standard desks with 2 box 1 file pedestals are specified without a center drawer option include one matching pencil tray.

## BASE MOLDING

The base moldings are made of profiled solid Black Walnut or Cherry.

## GLIDES

Glides are provided for every case and allow for 1 1/2" of adjustment.

## HINGES

Doors have European style hinges with a 95° opening.

## PULLS

Three pull options are available, please specify at time of order.

## TESTING INFORMATION

Stratford desks, credenzas, hutches, link units, and returns meet or exceed the testing requirements of ANSI/BIFMA X5.5-2014 and/or X5.9 - 2012.



**WOOD FINISHES**

Standard wood finishes are:

<b>SPECIES</b>	<b>FINISH</b>
Cherry	Light Cherry
	Natural Cherry
	American Cherry
	Medium Cherry
	Standard Cherry
	Imperial Cherry
Walnut	Appalachian Cherry
	Sable Cherry
	Natural Walnut
	Regular Walnut
	Mahogany on Walnut
	Dark Walnut
	Cordovan Walnut

**NATURAL CHARACTERISTICS OF WOOD**

Wood is a natural product with inherent color variations that will never be fully mitigated by the finishing process. Please anticipate variation in colors within a single unit, from piece to piece, and from Krug wood finish samples. If a very close match is required, a sample must be provided with the order and an upcharge will apply. Exact color matches are not possible.

**CUSTOM WOOD FINISHES**

Add 10% net to your order for special finishes, minimum charge is \$500 list per finish per order. (For example, on all orders up to \$5000 list, an upcharge of \$500 will apply, on orders \$5000 and up add 10% net to your order.)

For orders with special finishes, a sample that is a minimum 3” by 3” must be received with the order. Special finishes may add additional lead time to production schedules.

Since wood is a natural product, some variations in grain, color, and stain acceptance will occur. In our finishing processes, we try to minimize variations, but some variation between samples and finished goods should be anticipated.

**DUAL FINISH**

Add 10% net per item if specifying dual finish.

**STRATFORD | EDGE PROFILES**



**PROFILE - STANDARD**

The standard edge detail is included on the following Stratford products:

- desks
- linking units
- credenzas
- returns
- corner units
- 30” high and 57” high bookcases
- modular TP and TPR tops
- 30” high freestanding storage
- occasional tables
- conference tables



**PROFILE - INVERTED**

The inverted edge detail is included on the following Stratford products:

- hutches
- wall mounted overheads
- 71” high bookcase
- modular TPI tops
- 71” high and 84” high freestanding storage
- visual boards

# STRATFORD | PROFILES & OVERHANGS

Please use the following summary of products to determine the profile direction and overhang dimensions for all Stratford products.

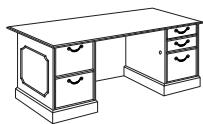

## DESKS 30" DEEP

Profile Location: profile on all four sides  
 Profile Direction: standard  
 Overhang: left 1 1/2"  
 right 1 1/2"  
 user 3/4"  
 guest 1 1/2"

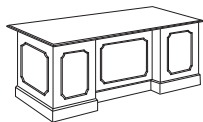

Picture Frame: on end panels, modesty panel and pedestal backs

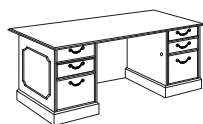

## DESKS 36" DEEP

Profile Location: profile on all four sides  
 Profile Direction: standard  
 Overhang: left 1 1/2"  
 right 1 1/2"  
 user 3/4"  
 guest 7 1/2"

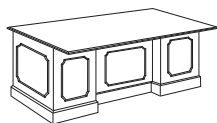

Picture Frame: on end panels, modesty panel and pedestal backs



## TABLE DESKS

Profile Location: profile on all four sides  
 Profile Direction: standard  
 Overhang: left 1 1/2"  
 right 1 1/2"  
 user 3/4"  
 guest 1 1/2"

Picture Frame: none

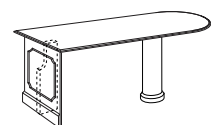

## BULLET AND P DESKS

Profile Location: profile on all sides  
 Profile Direction: standard  
 Overhang: end panel 1 1/2"  
 Picture Frame: on end panel

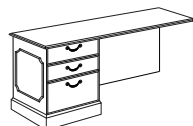

## RETURNS

Profile Location: profile on all four sides, coved  
 Profile Direction: standard  
 Overhang: end panel 1 1/2"  
 user 3/4"  
 guest 1 1/2"  
 Picture Frame: on end panel, modesty panel and pedestal back

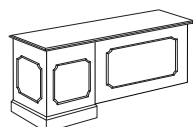

# STRATFORD | PROFILES & OVERHANGS

Please use the following summary of products to determine the profile direction and overhang dimensions for all Stratford products.

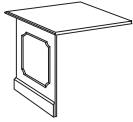

## LINK UNITS AND LINK TOPS

Profile Location: profile on guest and user sides, cover on connecting ends  
Profile Direction: standard  
Overhang: guest 1 1/2"  
Picture Frame: on modesty panel

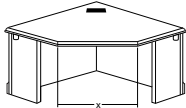

## CORNER UNITS

Profile Location: profile on outside and user sides, covered on connecting ends  
Profile Direction: standard  
Overhang: guest 1 1/2"  
Picture Frame: on both outside panels

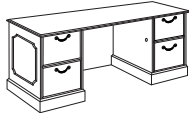

## CREDENZAS

Profile Location: profile on left, right and user side, flush on back edge  
Profile Direction: standard  
Overhang: left 1 1/2"  
right 1 1/2"  
user 3/4"  
back 1/8"  
Picture Frame: on left and right panels



## OVERHEADS

Profile Location: inverted profile left, right, and user side, flush on back edge  
Profile Direction: inverted  
Overhang: left 1"  
right 1"  
user 3/4"  
back flush

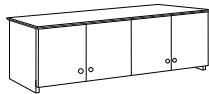

Picture Frame: none

Please specify if flush sides are necessary for the purpose of ganging overheads at time of order. Upcharge for this option is \$174 list.

# STRATFORD | PROFILES & OVERHANGS

Please use the following summary of products to determine the profile direction and overhang dimensions for all Stratford products.

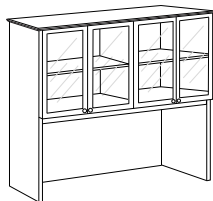

## HUTCHES

Profile Location: inverted profile on left, right, and user side, flush on back edge  
 Profile Direction: inverted  
 Overhang: left 1"  
 right 1"  
 user 3/4"  
 back flush  
 Picture Frame: none

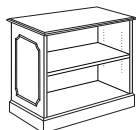
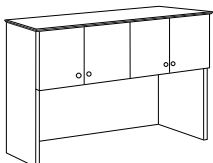

## BOOKCASES AND FREESTANDING STORAGE (30" HIGH ONLY)

Profile Location: profile on left, right, and user side, flush on back edge  
 Profile Direction: standard  
 Overhang: left 1 1/2"  
 right 1 1/2"  
 user 3/4" (if unit has doors or drawers)  
 1 1/2" (if unit is open)  
 back flush  
 Picture Frame: on left and right panels

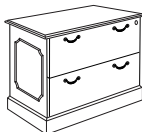

Bookcases have non-shown wood backs, finished color.  
 Freestanding and modular storage have non-shown wood veneer, finished and top coated backs.

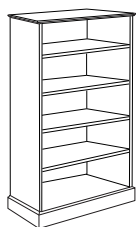

## BOOKCASES AND FREESTANDING STORAGE (57", 71" AND 84" HIGH)

Profile Location: profile on left, right, and user side, flush on back edge  
 Profile Direction: inverted  
 Overhang: left 1"  
 right 1"  
 user 3/4" (if unit has doors or drawers)  
 1 1/2" (if unit is open)  
 back flush  
 Picture Frame: none

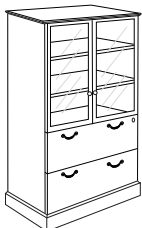

Bookcases have non-shown wood backs, finished color.  
 Freestanding and modular storage have non-shown wood veneer, finished and top coated backs.

# STRATFORD | DRAWER PULLS & LOCKS

Stratford traditional series offers a choice of three pull combinations as described below.

Please indicate a pull designation for every Stratford product on your order. There is no default selection and orders will not be processed until a pull selection is received.

## DEVON

Drawers are furnished with an arced Devon bail finished in antiqued brass and mounted with rosettes. Bookcase doors and hutch doors are provided with an antiqued brushed brass knob.



## CANTERBURY

Drawers are furnished with a Canterbury bail finished in antiqued brass and mounted with rosettes. Bookcase doors and hutch doors are provided with an antiqued brushed brass knob.



## AVON

All drawers, bookcase doors and hutch doors are provided with an antiqued brushed brass knob.



## LOCKS

Locks are provided as a standard features on all pedestal drawers, including those in desks, credenzas and freestanding or modular storage units. All lock plugs have an antiqued brass finish.

Optional locks are available on bookcase, hutch and overhead doors at an upcharge of \$116 list per set of (2) doors. Please specify at time of order. If a hutch or overhead has an uneven amount of doors the single lock required is also \$116.

## LOCK LOCATIONS

**Desk Pedestals:** Lock plugs are located in the kneespace of all desks, with the exception of desks with the center drawer option where the central locking system lock plug is located on the center of the drawer front.

**Hutches and Overheads:** Lock plugs are located on the lower inside corner of the doors.

**Bookcase Doors:** Lock plugs are located on the top inside corner of the door.

Suites can be keyed alike at no upcharge, please specify on your purchase order.

# STRATFORD | GROMMETS

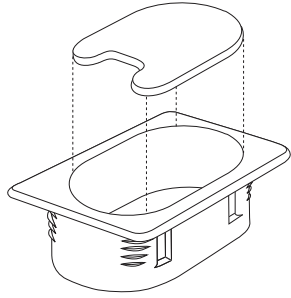

## GROMMETS

All products may be specified with either one black grommet or one brass grommet in a standard position at no upcharge. A \$125 list upcharge will apply to additional grommets in standard positions and for grommets in non-standard positions a \$288 list upcharge will apply.

The grommet position must be indicated for each case on the purchase order.

Standard Grommet  
Black, rectangular, 4 1/8" x 2 11/16"

Antiqued Brass Grommet  
2 5/8" x 1 1/2"

Grommets can also be field installed with power drill, 2 1/4" hole saw and rasp or saber saw. Template for drilling is available.

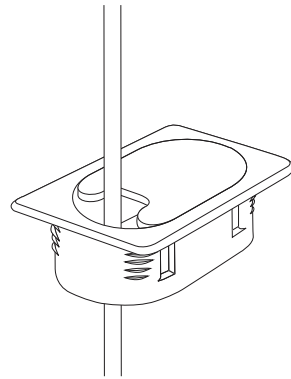

## STANDARD GROMMET POSITIONS

### Desks

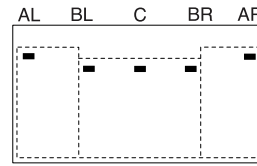
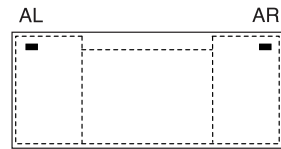

### 30" Deep Desks:

Position Code:

- AL - left corner
- BL - left end beside pedestal gable
- C - center
- BR - right end beside pedestal gable
- AR - right corner

### 36" and 42" Deep Desks:

Position Code:

- AL - left corner
- BL - left end beside pedestal gable
- C - center
- BR - right end beside pedestal gable
- AR - right corner

**NOTE:** BL, 'C' and 'BR' locations are not available on 36" deep desks.

### Curvilinear Tops

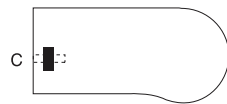

Position Code:

- C - center

This key applies to all bullet and P shaped tops. The support panel is notched out to accommodate cable management and also allows the installation of a pop-up power grommet.

### Linking Units, Credenzas & Returns

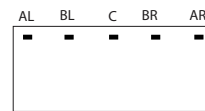

Grommets cannot be located over pedestals on 20" or 24" units

**NOTE:** 'BL' and "BR" are only available on 42" on longer.



# STRATFORD | GROMMETS & LAMINATE WORKSURFACES

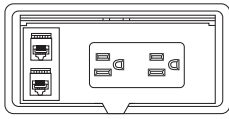

mounted in a hutch back panel



used as a surface grommet

## POWER / DATA / VOICE GROMMET

This unit is supplied in the wired hutches or can be ordered a surface mount power/data/voice option as a 98PDVM.

Black, rectangular with recessed cover.

Includes two power outlets, one voice port, and one data port.

**POWER DETAILS:**  
two Simplex outlets  
15 Amp, 10 ft. cord

**COMMUNICATION DETAILS:**  
one RJ11 phone line coupler  
one RJ45 data coupler

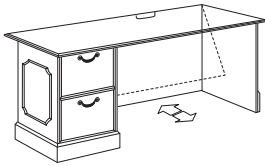

## WIRE MANAGEMENT CUT-OUT AND HINGED MODESTY PANELS

Returns, link units and credenzas with fixed modesty panels can be specified with an 8" x 1 1/2" wire management cut-out. All hinged modesty panels feature a cut-out as a standard.

The discreet cut-out allows for clean and easy access to power, data and communication sources.

# STRATFORD | LAMINATE WORKSURFACES

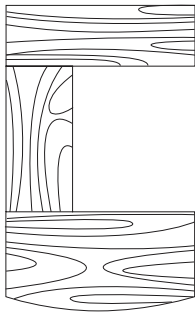

## LAMINATE WORKSURFACES

Laminate worksurfaces are available at an upcharge of 10% (a higher upcharge may apply to specially priced plastic laminates).

Where there are wood profile edges on worksurface tops, they will remain as wood profiles on laminate tops.

Where there are flush edges, as in the backs of link units, there will be laminate self edges. Please reference the illustration at the bottom of this page.

Krug will order and procure laminates. Purchase orders with a plastic laminate option must include laminate name.

When specifying laminate worksurfaces, the grain direction is such that the grain pattern runs the length of each surface, as shown in the diagram on the left.

Please contact Krug Customer Service for questions pertaining to laminate grain direction.

# STRATFORD | NON-STANDARD PRODUCT GUIDELINES FOR PRICING

## PRICING METHOD

Custom widths: Apply the price of the same unit in the price list that is one standard size larger than the desired case size (but same depth).  
For example: The required custom dimension is 74" x 24". The first standard size above this is 78" x 24", so in this case, you would apply the price of the 78" x 24" unit.

Custom depths: Apply the price for the same unit one size deeper (but same width).  
For example: The required custom dimension is 72" x 26". The first standard size above this is 72" x 30", so in this case, you would apply the price of the 72" x 30" unit.

Custom width & depths: Apply the price for the same unit both one size wider and one size deeper.  
For example: The required custom dimension is 74" x 26". The first standard size above this is 84" x 30", so in this case, you would apply the price of the 84" x 30" unit.

Custom height of desk height cases: Add 18%. (31-32" HI)

## OTHER PRICING METHODS

cases where tops are flush left/right or both, <b>add:</b>	\$92 list
Grommets in non-standard positions, <b>add:</b>	\$288 list
To remove hutch or overhead doors, <b>deduct:</b>	4% list
convert 5-hi hutch to 6-hi hutch, <b>add:</b>	20% list
Bookcases with optional pull out printer shelf at standard shelf height, <b>add:</b>	\$181 list
Bookcases with optional vent in back (includes 2 vents and 1 grommet), <b>add:</b>	\$230 list
storage units flush, <b>add:</b>	\$152 list
2 lateral file and 3 or 4 closed shelves - convert to half open, half closed shelves, <b>add:</b>	15% list
2 lateral file and 3 or 4 closed shelves - convert to half open, half wardrobe, <b>add:</b>	15% list
To remove storage doors for open shelves, <b>deduct:</b>	4% list

## EXCEPTIONS TO THE PRICING METHODS ABOVE

- Sizes larger than the largest shown Price List.
- Non-standard extension on drawer slides.
- Non-standard drawer depths in standard depth pedestals.
- Glass door - any style.
- Glass - face mounted modesty panels.
- Perforated modesty panels.
- Cases with curvilinear tops where the radius becomes non-standard.
- A/V cabinets.
- Any case with flipper doors.

Please contact Specials Coordinator or Krug Customer Service at 1.888.578.KRUG if you require assistance.

**PLEASE NOTE:** Cases with non-standard features do not apply to the rules above.  
Contact Krug Customer Service if you require assistance.

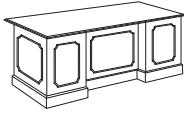

### Breakfront Modesty Panel

All single pedestal and double pedestal desks have a breakfront modesty panel on the guest side of the desk. The dimension of recess is 4 1/2".

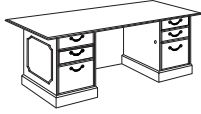

### Oversized Top Option

The oversized top option increases the overhang on the left and right sides of desks to 4 1/2" on each end, the guest and user side overhang remain unchanged.

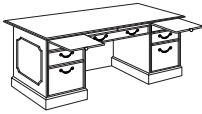

### Center Drawer Option

Desks specified with the optional locking center drawer include the following features:

- center drawer lined with burgundy felt and a pencil tray.
- a pull out dictation slide in each pedestal
- a central locking system activated by a single lock located on the center drawer front

Recent modifications:

- dictation slides are flush with drawer fronts and feature molding detail
- center drawer extends to underside of top with the lock on the drawer front

### Chassis Dimensions

Please use the reference chart below to determine chassis dimensions, top dimensions, and overhang dimensions for all desk sizes:

Desk	Chassis dimension	Left overhang	Right overhang	Guest overhang	User overhang
60" x 30"	57" x 27"	1 1/2"	1 1/2"	1 1/2"	3/4"
66" x 30"	63" x 27"	1 1/2"	1 1/2"	1 1/2"	3/4"
66" x 36"	63" x 27"	1 1/2"	1 1/2"	7 1/2"	3/4"
72" x 36" (oversized top)	63" x 27"	4 1/2"	4 1/2"	7 1/2"	3/4"
72" x 36"	69" x 27"	1 1/2"	1 1/2"	7 1/2"	3/4"
78" x 36" (oversized top)	69" x 27"	4 1/2"	4 1/2"	7 1/2"	3/4"
78" x 42"	75" x 33"	1 1/2"	1 1/2"	7 1/2"	3/4"
84" x 42" (oversized top)	75" x 33"	4 1/2"	4 1/2"	7 1/2"	3/4"
84" x 42"	81" x 33"	1 1/2"	1 1/2"	7 1/2"	3/4"

Dimensions have been rounded to the nearest 1/4", please contact Customer Service for exact measurements.

# STRATFORD | CREDENZAS

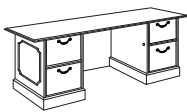

### Oversized Top Option

The oversized top option increases the overhang on the left and right sides of credenzas to 4 1/2" on each side, the guest and user side overhang remain unchanged. When using a hutch and credenza combination, we do not recommend specifying a hutch greater in size than the standard chassis size of the credenza. The left/right extensions on the oversized top should not be used for the support of a hutch.

### Chassis Dimensions

Please use the reference chart below to determine chassis dimensions, top dimensions, and overhang dimensions for all desk sizes:

	Credenza dimension	Chassis overhang	Left overhang	Right overhang	Guest User overhang
66" x 20"	63" x 18 1/4"	1 1/2"	1 1/2"	3/4"	1/8"
72" x 20" (oversized top)	63" x 18 1/4"	4 1/2"	4 1/2"	3/4"	1/8"
66" x 24"	63" x 22 1/4"	1 1/2"	1 1/2"	3/4"	1/8"
72" x 24" (oversized top)	63" x 22 1/4"	4 1/2"	4 1/2"	3/4"	1/8"
72" x 20"	69" x 18 1/4"	1 1/2"	1 1/2"	3/4"	1/8"
78" x 20" (oversized top)	69" x 18 1/4"	4 1/2"	4 1/2"	3/4"	1/8"
72" x 24"	69" x 22 1/4"	1 1/2"	1 1/2"	3/4"	1/8"
78" x 24" (oversized top)	69" x 22 1/4"	4 1/2"	4 1/2"	3/4"	1/8"
78" x 20"	75" x 18 1/4"	1 1/2"	1 1/2"	3/4"	1/8"
84" x 20" (oversized top)	75" x 18 1/4"	4 1/2"	4 1/2"	3/4"	1/8"
78" x 24"	75" x 22 1/4"	1 1/2"	1 1/2"	3/4"	1/8"
84" x 24" (oversized top)	75" x 22 1/4"	4 1/2"	4 1/2"	3/4"	1/8"
84" x 20"	81" x 18 1/4"	1 1/2"	1 1/2"	3/4"	1/8"
84" x 24"	81" x 18 1/4"	1 1/2"	1 1/2"	3/4"	1/8"

Dimensions have been rounded to the nearest 1/4", please contact Customer Service for exact measurements.

# STRATFORD | OVERHEADS & HUTCHES



## OVERHEADS

Overheads include tasklights that are factory installed and require no field adjustment. Tasklights are mounted beneath the cabinet and hidden from view. Cords run down the right hand side of the tasklight to the worksurface where they can be routed behind the worksurface top. The use of a wall mounted tackboard conceals the cord from view.

Tackboards must be ordered separately and can be specified in any fabric grade (1-9). Wall mounted tackboards for overheads are supplied with all necessary hardware for installation.

Locks are optional on overheads and can be specified at time of order for an upcharge of \$116 list per set of (2) doors.

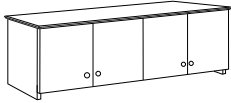

## HUTCHES

Hutches include tasklights that are factory installed and require no field adjustment. Tasklights are mounted beneath the cabinet and hidden from view.

A tackboard in grade 1 fabric is included with most hutches, see the hutch product section for specific products. Upcharges for higher graded fabrics are listed on page 858. Tackboard fabric selections should be supplied with the order information, fabric options are listed on page 5 of this price guide.

Tackboards for hutches are installed at the factory and require no additional set up on site.

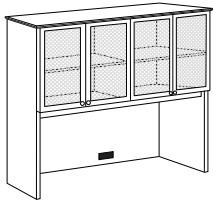

## POWER/DATA/VOICE GROMMET

Access to power and data is made simple by using a hutch with a power/data/voice module built right into the tackboard. The module is fully installed at the factory but can be removed to connect data links on site. It features a flip door that retracts into the case of the unit when open.

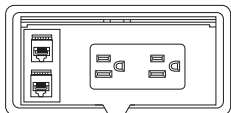

## INSTALLATION

Hutch and overhead installation instructions are included with every case, but basic installation instructions can be found in this guide on page 846. All required mounting hardware is included with all hutches.

## CONNECTING WORKSURFACES

It is important that the product is in its final position and the primary worksurface is leveled before connecting other joining pieces.

Detailed installation instructions are included with each unit, or available from Krug Customer Service.

Units are connected with mending plates under worksurfaces, and linking brackets on modesty and end panels. Locate connections and attach the mending plate under the worksurface. Level pieces if necessary by adjusting the glides to achieve flush and firm joints before completing installation of all hardware.

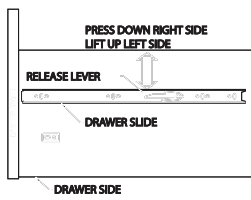

## DRAWER REMOVAL

To remove pedestal drawers, open to the extended position, press down on the right side nylon release lever and pull the drawers up on left side lever at the same time. Continue pulling the drawer out of the case.

## GLIDE ADJUSTMENTS

Raise one corner of the unit at a time and adjust the glide to the desired height by turning the glide in the hole. Make sure unit is level after adjusting the glides.

Please note that the maximum adjustment range of the glides is 1/2".

When moving units after glides have been inserted, dial the glides to the lowest position to prevent damage to the case.

## BOOKCASE OR HUTCH DOOR ADJUSTMENT

Hinges on all hutch and bookcase doors are designed to be adjusted for depth, horizontal and vertical adjustment by means of screws into the hinge mounting plates.

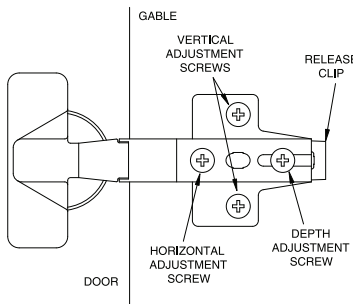

To remove a door, pull the release clip away from the case, disconnecting the hinges.

## OVERHEAD INSTALLATION

The wall mounted overhead storage units must be installed on wall studs. The first step for installation is to locate the studs in the wall where the overhead is to be mounted. Measure the stud center line location and use this measurement to mark the hole locations on the mounting rail and the overhead back. Drill clearance holes at the hole locations. Hole requirements will depend on the fasteners chosen by the installer. 2 1/2" x #10 wood screws are adequate if going into wood studs. If studs cannot be accessed, then appropriate drywall plugs or butterfly bolts should be used. We recommend 2 fasteners per stud.

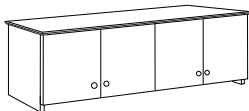

Fasten the mounting rail to the wall ensuring that it is level. Hang the overhead on the mounting rail and then fasten it to the wall. This prevents accidental removal and also allows for some leveling adjustment.

# STRATFORD | SAMPLE CONFIGURATIONS

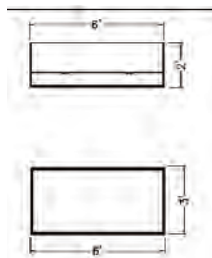
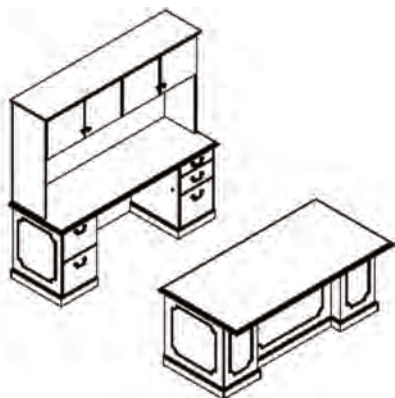

	Model	Cherry Walnut
Desk	98D72364LORF	3738
Hutch	98HT721640	3617
Credenza	98C72244LDRF	4129
<b>TOTAL</b>		<b>11,484</b>

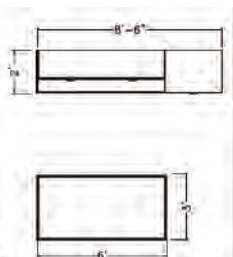
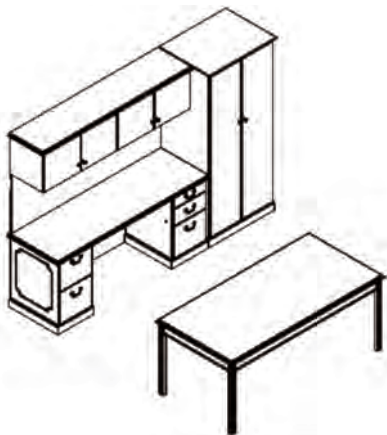

	Model	Cherry Walnut
Desk	98TD7236	3450
Overhead	98OH7216	2151
Tackboard	98TBOH72	387
Credenza	98C72244LDRF	4129
Flush Left Storage	option 98WR30247101	92 3682
<b>TOTAL</b>		<b>13,891</b>

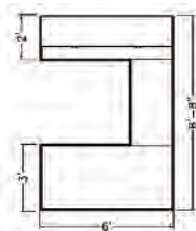
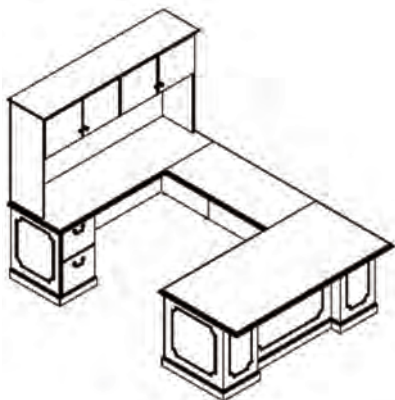

	Model	Cherry Walnut
Desk	98D72364LORF	3738
Link Unit	98LU4224H	1474
Hutch	98HT721640	3870
Credenza	98C72244LDR0	3839
<b>TOTAL</b>		<b>12,921</b>

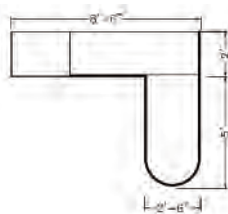
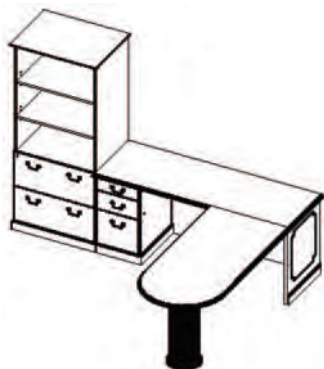

	Model	Cherry Walnut
Return	98BR6030	1629
Credenza	98C7220LFR0	3596
Flush Right Storage	option 98ST30207103	92 4241
<b>TOTAL</b>		<b>9,558</b>

# STRATFORD | DESKS

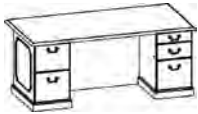
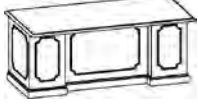
Description	Model	Cherry		W	D	H	KW	Shipping	
		Walnut						Weight	Cubic Feet
Double Pedestal Desk	98D60304LDRD	4802		59.75	29.75	30.5	25.5	273	42
	98D60304LDRF	4802		59.75	29.75	30.5	25.5	273	42
	98D60304LFRD	4802		59.75	29.75	30.5	25.5	273	42
	98D60304LFRF	4802		59.75	29.75	30.5	25.5	273	42
	98D66304LDRD	4828		65.75	29.75	30.5	31.5	280	46
	98D66304LDRF	4828		65.75	29.75	30.5	31.5	280	46
guest side of a 36" deep desk**	98D66304LFRD	4828		65.75	29.75	30.5	31.5	280	46
	98D66304LFRF	4828		65.75	29.75	30.5	31.5	280	46
	98D66364LDRD	4853		65.75	35.75	30.5	31.5	295	55
	98D66364LDRF	4853		65.75	35.75	30.5	31.5	295	55
	98D66364LFRD	4853		65.75	35.75	30.5	31.5	295	55
	98D66364LFRF	4853		65.75	35.75	30.5	31.5	295	55
	98D72364LDRD	4923		71.75	35.75	30.5	37.5	310	60
	98D72364LDRF*	4923		71.75	35.75	30.5	37.5	310	60
	98D72364LFRD	4923		71.75	35.75	30.5	37.5	310	60
	98D72364LFRF	4923		71.75	35.75	30.5	37.5	310	60
	98D78424LDRD	5035		77.75	41.75	30.5	43.5	327	72
	98D78424LDRF	5035		77.75	41.75	30.5	43.5	327	72
	98D78424LFRD	5035		77.75	41.75	30.5	43.5	327	72
	98D78424LFRF	5035		77.75	41.75	30.5	43.5	327	72
	98D84424LDRD	5148		83.75	41.75	30.5	49.5	337	78
	98D84424LDRF	5148		83.75	41.75	30.5	49.5	337	78
	98D84424LFRD	5148		83.75	41.75	30.5	49.5	337	78
	98D84424LFRF	5148		83.75	41.75	30.5	49.5	337	78

### ORDERING NOTES:

Laminate worksurfaces are available at a 10% upcharge. 30" deep Stratford desks have a 1-1/2" overhang on the guest side. 36" deep Stratford desks have a 7 1/2" overhang on the guest side. See page 843 for more information on the desks overhang and chassis dimensions. A burled walnut top option is available at a 20% upcharge.

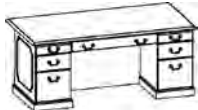
Double Pedestal Desk with Center Drawer Option	98D60304LFCDRF	5101		59.75	29.75	30.5	25.5	303	42
	98D66304LFCDRF	5145		65.75	29.75	30.5	31.5	310	46
	98D66364LFCDRF	5181		65.75	35.75	30.5	31.5	325	55
	98D72364LFCDRF*	5269		71.75	35.75	30.5	37.5	340	60
	98D78424LFCDRF	5396		77.75	41.75	30.5	43.5	357	72
	98D84424LFCDRF	5526		83.75	41.75	30.5	49.5	367	78
									

### ORDERING NOTES:

The center drawer option includes:

- a felt-lined drawer with pencil tray
- two pull-out dictation slides on the user side of the desk.
- a central locking system activating center drawer and both pedestals with a single lock located on the left pedestal inside gable.

Laminate worksurfaces are available at a 10% upcharge. A burled walnut top option is available at a 20% upcharge.

### DIMENSION KEY

W — width  
D — depth  
H — height of worksurface  
KW— kneehole width

Dimensions are in inches and approximate. Contact Customer Service if dimensions are critical.

\*See page 5 for KrugExpress program.

### CODE DESCRIPTION

0 - no pedestal  
4 - full height pedestals  
D - 2 file drawer  
F - 2 box, 1 file drawe  
L - left hand support position  
R - right hand support position  
CD - center drawer  
OT - oversized top option  
BT - bow top option  
CC - corner credenza

### STANDARD FINISHES

For a complete list of standard wood finishes please see page 772.

### WIRING GROMMET

One rectangular black or one antique brass grommet in a standard position is optional at no charge. Please note grommet choice clearly on order form. Additional grommets are available at an upcharge of \$125 list.

# STRATFORD | DESKS

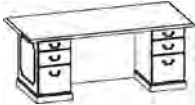
Description	Model	Cherry Walnut	W	D	H	Shipping Weight	Cubic Feet
	OT98D66364	251	71.75	35.75	-	15	-
	OT98D72364*	251	77.75	35.75	-	15	-
	OT98D78424	251	83.75	41.75	-	15	-

### ORDERING NOTES:

The oversized top option is only available on stand-alone double pedestal desks and cannot be used in conjunction with any other run-off or connecting worksurfaces. Specifying the oversized top option increases the top width, increasing the left and right overhang measurement to 4-1/2". The guest side remains 7-1/2" (as is standard for 36" and 42" deep desks). Laminate worksurfaces are available at a 10% upcharge.

Single Pedestal Desk	Model	Price	W	D	H	Shipping Weight	Cubic Feet
 guest side of a 36" deep desk**	98D60304LDR0	3311	59.75	29.75	30.5	215	42
	98D60304LFR0	3311	59.75	29.75	30.5	215	42
	98D60304LORD	3311	59.75	29.75	30.5	215	42
	98D60304LORF	3311	59.75	29.75	30.5	215	42
	98D66304LDR0	3338	65.75	29.75	30.5	222	46
	98D66304LFR0	3338	65.75	29.75	30.5	222	46
	98D66304LORD	3338	65.75	29.75	30.5	222	46
	98D66304LORF	3338	65.75	29.75	30.5	222	46
	98D66364LDR0	3358	65.75	35.75	30.5	237	55
	98D66364LFR0	3358	65.75	35.75	30.5	237	55
	98D66364LORD	3358	65.75	35.75	30.5	237	55
	98D66364LORF	3358	65.75	35.75	30.5	237	55
	98D72364LDR0	3738	71.75	35.75	30.5	252	60
	98D72364LFR0	3738	71.75	35.75	30.5	252	60
	98D72364LORD*	3738	71.75	35.75	30.5	252	60
	98D72364LORF	3738	71.75	35.75	30.5	252	60
	98D78424LDR0	4108	77.75	41.75	30.5	269	72
	98D78424LFR0	4108	77.75	41.75	30.5	269	72
	98D78424LORD	4108	77.75	41.75	30.5	269	72
	98D78424LORF	4108	77.75	41.75	30.5	269	72
98D84424LDR0	4487	83.75	41.75	30.5	279	78	
98D84424LFR0	4487	83.75	41.75	30.5	279	78	
98D84424LORD	4487	83.75	41.75	30.5	279	78	
98D84424LORF	4487	83.75	41.75	30.5	279	78	

### ORDERING NOTES:

The oversized top option is only available on stand-alone double pedestal desks and cannot be used in conjunction with any other run-off or connecting worksurfaces. Specifying the oversized top option increases the top width, increasing the left and right overhang measurement to 4-1/2". The guest side remains 7-1/2" (as is standard for 36" and 42" deep desks). Laminate worksurfaces are available at a 10% upcharge.

### ORDERING PROCEDURES

To order, please specify the following:

- 1) Krug product model number
- 2) Wood species and finish, see page 841
- 4) Pull style and finish, see page 845
- 5) Grommet location and style if applicable

\* Indicates model illustrated by line drawing

### CODE DESCRIPTION

0 - no pedestal  
 4 - full height pedestals  
 D - 2 file drawer  
 F - 2 box, 1 file drawer  
 L - left hand support position  
 R - right hand support position  
 CD - center drawer  
 OT - oversized top option  
 BT - bow top option  
 CC - corner credenza

### STANDARD FINISHES

For a complete list of standard wood finishes please see page 772.



# STRATFORD | DESKS

Description	Model	Cherry		W	D	H	KW	Shipping	
		Walnut						Weight	Cubic Feet
	98D66304LOCDRF	3565		65.75	29.75	30.5	46.5	252	46
	98D66304LFCDR0	3565		65.75	29.75	30.5	46.5	252	46
	98D66364LOCDRF	3601		65.75	35.75	30.5	46.5	267	55
	98D66364LFCDR0	3601		65.75	35.75	30.5	46.5	267	55
	98D72364LOCDRF*	3997		71.75	35.75	30.5	52.5	282	60
	98D72364LFCDR0	3997		71.75	35.75	30.5	52.5	282	60
	98D78424LOCDRF	4394		77.75	41.75	30.5	58.5	299	72
	98D78424LFCDR0	4394		77.75	41.75	30.5	58.5	299	72
	98D84424LOCDRF	4788		83.75	41.75	30.5	64.5	309	78
	98D84424LFCDR0	4788		83.75	41.75	30.5	64.5	309	78

guest side of a 36" deep desk\*\*

### ORDERING NOTES:

The center drawer option includes:

- a felt-lined drawer with pencil tray
- a central locking system activating center drawer and pedestal with a single lock located on the inside pedestal gable.
- pull-out dictation slide on the user side of the desk.

The space left between the pencil drawer and the open end of the desk allows for a 24" run off. Laminate worksurfaces are available at a 10% upcharge. A burled walnut top option is available at a 20% upcharge.

Desk Shells	Model	Cherry		W	D	H	KW	Shipping	
		Walnut						Weight	Cubic Feet
	98S6636LOR0*	2237		65.75	35.75	30.5	60.5	121	55
	98S7236LOR0	2484		71.75	35.75	30.5	66.5	137	60
	98S7836LOR0	2756		77.75	35.75	30.5	72.5	153	64

Bow Top Option Upcharge	Model	Cherry		W	D	H	KW	Shipping	
		Walnut						Weight	Cubic Feet
	98D6636BT	510		-	-	-	-	-	-
	98D7236BT	551		-	-	-	-	-	-
	98D7842BT	564		-	-	-	-	-	-
	98D8442BT	571		-	-	-	-	-	-

### ORDERING NOTES:

The bow top option is available on all the desk sizes listed above. Please add "BT" to the model number of the desk and add the upcharge shown above. The bowtop option tapers the overhang back on the left and right sides, the depth of the overhang at the widest point is 7 1/2". Laminate worksurfaces are available at a 10% upcharge.

### DIMENSION KEY

W — width  
D — depth  
H — height of work surface  
KW— kneehole width

Dimensions are in inches and approximate. Contact Customer Service if dimensions are critical.

\*See page 5 for KrugExpress program.

### CODE DESCRIPTION

0 - no pedestal  
4 - full height pedestals  
D - 2 file drawer  
F - 2 box, 1 file drawe  
L - left hand support position  
R - right hand support position  
CD - center drawer  
OT - oversized top option  
BT - bow top option  
CC - corner credenza

### STANDARD FINISHES

For a complete list of standard wood finishes please see page 772.

### WIRING GROMMET

One rectangular black or one antique brass grommet in a standard position is optional at no charge. Please note grommet choice clearly on order form. Additional grommets are available at an upcharge of \$125 list.

# STRATFORD | DESKS

Description	Model	Cherry		W	D	H	KW	Shipping Weight	Cubic Feet
		Walnut							
Queen Ann Table Desk	98TDQ7236	4058		83.75	35.75	30.5	65.75	150	60



### ORDERING NOTES:

Optional lock: Please add \$116 list and specify lock option in the product description. This item is NOT available on KrugExpress. Laminate worksurfaces are available at a 10% upcharge. Please note that pedestals can not be used with table desks.

Table Desk	98TD7236*	3691		71.75	35.75	30.5	66.5	131	12
	98TD7842	4098		77.75	41.75	30.5	72.5	148	14



### ORDERING NOTES:

Table desk includes a felt-liner center drawer with pencil tray. To add lock, please specify lock option and add \$116 list. The lock plug is located above the center drawer in the rail. The table desk is shipped knocked down. This table desk is NOT available on KrugExpress. Laminate worksurfaces are available at a 10% upcharge.

Bullet Desk, Post Leg	98BD6030	2342		59.75	29.75	30.5	140	36
	98BD6630	2387		65.75	29.75	30.5	154	40
	98BD7230	2434		71.75	29.75	30.5	170	47
	98BD6636	2412		65.75	35.75	30.5	184	43
	98BD7236*	2484		71.75	35.75	30.5	200	51

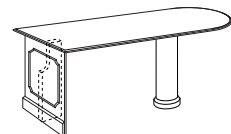

"P" Desk, Post Leg	98PR7230L	3054		71.75	35.75	30.5		189	43
	98PR7230R	3054		71.75	35.75	30.5		189	43
	98PR7236L	3119		71.75	41.75	30.5		205	51
	98PR7236R*	3119		71.75	41.75	30.5		205	51
	98PR7830L	3177		77.75	35.75	30.5		219	47
	98PR7830R	3177		77.75	35.75	30.5		219	47
	98PR7836R	3236		77.75	41.75	30.5		233	56
	98PR7836R	3236		77.75	41.75	30.5		233	56
	98PR8430L	3334		83.75	35.75	30.5		247	50
	98PR8430R	3334		83.75	35.75	30.5		247	50
	98PR8436L	3419		83.75	41.75	30.5		260	60
	98PR8436R	3419		83.75	41.75	30.5		260	60

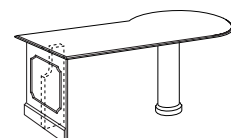

### ORDERING NOTES:

"P" desk/return legs are 10.5 in diameter. Laminate worksurfaces are available at a 10% upcharge.

### ORDERING PROCEDURES

To order, please specify the following:

- 1) Krug product model number
- 2) Wood species and finish, see page 841
- 4) Pull style and finish, see page 845
- 5) Grommet location and style if applicable

\* Indicates model illustrated by line drawing

### CODE DESCRIPTION

- 0 - no pedestal
- 4 - full height pedestals
- D - 2 file drawer
- F - 2 box, 1 file drawer
- L - left hand support position
- R - right hand support position
- CD - center drawer
- OT - oversized top option
- BT - bow top option
- CC - corner credenza

### STANDARD FINISHES

For a complete list of standard wood finishes please see page 772.

### LOCKS

Locks are standard on all lateral file drawers. Optional locks on bookcase doors are available at a \$116 list upcharge. Please specify at time of order.

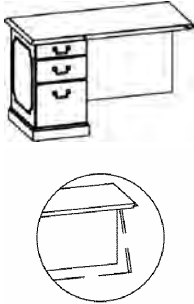
Description	Model	Cherry Walnut	W	D	H	KW	Shipping Weight	Cubic Feet
	98RH4220L4D	2894	41.75	20.5	30.5	23	114	22
	98RH4220L4F	2894	41.75	20.5	30.5	23	114	22
	98RH4220R4D	2894	41.75	20.5	30.5	23	114	22
	98RH4220R4F	2894	41.75	20.5	30.5	23	118	22
	98RH4224L4D	2935	41.75	23.75	30.5	23	118	26
	98RH4224L4F	2935	41.75	23.75	30.5	23	114	26
	98RH4224R4D	2935	41.75	23.75	30.5	23	114	26
	98RH4224R4F	2935	41.75	23.75	30.5	23	114	26
	98RH4820L4D	2960	47.75	20.5	30.5	27	118	25
	98RH4820L4F	2960	47.75	20.5	30.5	27	118	25
	98RH4820R4D	2960	47.75	20.5	30.5	27	118	25
	98RH4820R4F	2960	47.75	20.5	30.5	27	122	25
	98RH4824L4D	2973	47.75	23.75	30.5	27	122	29
	98RH4824L4F*	2973	47.75	23.75	30.5	27	118	29
	98RH4824R4D	2973	47.75	23.75	30.5	27	118	29
	98RH4824R4F	2973	47.75	23.75	30.5	27	118	29
	98RH5420L4D	2998	53.75	20.5	30.5	35	122	28
	98RH5420L4F	2998	53.75	20.5	30.5	35	122	28
	98RH5420R4D	2998	53.75	20.5	30.5	35	122	28
	98RH5420R4F	2998	53.75	20.5	30.5	35	126	28
	98RH5424L4D	3034	53.75	23.75	30.5	35	126	32
	98RH5424L4F	3034	53.75	23.75	30.5	35	122	32
	98RH5424R4D	3034	53.75	23.75	30.5	35	122	32
	98RH5424R4F	3034	53.75	23.75	30.5	35	122	32
	98RH6020L4D	3098	59.75	20.5	30.5	41	126	31
	98RH6020L4F	3098	59.75	20.5	30.5	41	126	31
	98RH6020R4D	3098	59.75	20.5	30.5	41	126	31
	98RH6020R4F	3098	59.75	20.5	30.5	41	130	31
	98RH6024L4D	3155	59.75	23.75	30.5	41	130	36
	98RH6024L4F	3155	59.75	23.75	30.5	41	126	36
	98RH6024R4D	3155	59.75	23.75	30.5	41	126	36
	98RH6024R4F	3155	59.75	23.75	30.5	41	126	36
	98RH6620L4D	3311	65.75	20.5	30.5	47	130	33
98RH6620L4F	3311	65.75	20.5	30.5	47	130	33	
98RH6620R4D	3311	65.75	20.5	30.5	47	130	33	
98RH6620R4F	3311	65.75	20.5	30.5	47	165	33	
98RH6624L4D	3349	65.75	23.75	30.5	47	165	39	
98RH6624L4F	3349	65.75	23.75	30.5	47	130	39	
98RH6624R4D	3349	65.75	23.75	30.5	47	130	39	
98RH6624R4F	3349	65.75	23.75	30.5	47	130	39	

### ORDERING NOTES:

Modesty panels on returns are raised above the base mounding. Laminate worksurfaces are available at a 10%

upcharge. For wire management cut out option on modesty panel add \$174 list upcharge. For hinged modesty panel upcharge insert Y after the C in the model number. e.g. 98CY7224LORF

### DIMENSION KEY

W — width  
D — depth  
H — height of worksurface  
KW— kneehole width

Dimensions are in inches and approximate.  
Contact Customer Service if dimensions are critical.

\*See page 5 for KrugExpress program.

### CODE DESCRIPTION

0 - no pedestal  
4 - full height pedestals  
D - 2 file drawer  
F - 2 box, 1 file drawe  
L - left hand support position  
R - right hand support position  
CD - center drawer  
OT - oversized top option  
BT - bow top option  
CC - corner credenza

### STANDARD FINISHES

For a complete list of standard wood finishes please see page 772.

### WIRING GROMMET

One rectangular black or one antique brass grommet in a standard position is optional at no charge. Please note grommet choice clearly on order form. Additional grommets are available at an upcharge of \$125 list.

# STRATFORD | RETURNS

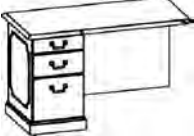
Description	Model	Cherry		W	D	H	KW	Shipping Weight	Cubic Feet
		Walnut							
 Single Pedestal Return, Continued	98RH7220L4D	3396		71.75	20.5	30.5	53	165	36
	98RH7220L4F*	3396		71.75	20.5	30.5	53	165	36
	98RH7220R4D	3396		71.75	20.5	30.5	53	165	36
	98RH7220R4F	3396		71.75	20.5	30.5	53	170	36
	98RH7224L4D	3459		71.75	23.75	30.5	53	170	42
	98RH7224L4F	3459		71.75	23.75	30.5	53	165	42
	98RH7224R4D	3459		71.75	23.75	30.5	53	165	42
	98RH7224R4F	3459		71.75	23.75	30.5	53	165	42

### ORDERING NOTES:

Modesty panels on returns are raised above the base mounding. Laminate worksurfaces are available at a 10% upcharge. For wire management cut out option on modesty panel add \$174 list upcharge. For hinged modesty

Return Shells	Model	Cherry		W	D	H	KW	Shipping Weight	Cubic Feet
		Walnut							
	98RH4224L0*	1746		41.75	23.75	30.5	39.25	68	26
	98RH4224R0	1746		41.75	23.75	30.5	39.25	68	26
	98RH4824L0	1768		47.75	23.75	30.5	45.25	72	29
	98RH4824R0	1768		47.75	23.75	30.5	45.25	72	29

Bullet Return, Post Leg	Model	Cherry		W	D	H	KW	Shipping Weight	Cubic Feet
		Walnut							
	98BR6030	1629		59.75	29.75	30.5		66	3
	98BR6630	1650		65.75	29.75	30.5		81	4
	98BR6636	1672		65.75	35.75	30.5		101	4
	98BR7230	1705		71.75	29.75	30.5		106	4
	98BR7236*	1758		71.75	35.75	30.5		116	5

### ORDERING NOTES:

Bullet desk/return legs are 10.5 in diameter. Bullet desks are available in 72" lengths only for KrugExpress. Laminate worksurfaces are available at a 10% upcharge.

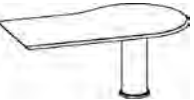
"P" Return, Post Leg	Model	Cherry		W	D	H	KW	Shipping Weight	Cubic Feet
		Walnut							
	98PR7230L	2606		71.75	35.75	30.5		112	43
	98PR7230R	2606		71.75	35.75	30.5		112	43
	98PR7236L	2719		71.75	41.75	30.5		128	51
	98PR7236R*	2719		71.75	41.75	30.5		128	51
	98PR7836L	2778		77.75	41.75	30.5		128	47
	98PR8430L	2778		83.75	35.75	30.5		128	47
	98PR8430R	2872		83.75	35.75	30.5		128	56
	98PR8436L	2872		83.75	41.75	30.5		128	56
	98PR8436R	2952		83.75	41.75	30.5		128	50
	98PR7836R	2952		77.75	41.75	30.5		128	50
	98PR7830L	3037		77.75	35.75	30.5		142	60
	98PR7830R	3037		77.75	35.75	30.5		142	60

### ORDERING PROCEDURES

To order, please specify the following:

- 1) Krug product model number
- 2) Wood species and finish, see page 841
- 4) Pull style and finish, see page 845
- 5) Grommet location and style if applicable

\* Indicates model illustrated by line drawing

### CODE DESCRIPTION

- 0 - no pedestal
- 4 - full height pedestals
- D - 2 file drawer
- F - 2 box, 1 file drawer
- L - left hand support position
- R - right hand support position
- CD - center drawer
- OT - oversized top option
- BT - bow top option
- CC - corner credenza

### STANDARD FINISHES

For a complete list of standard wood finishes please see page 772.

### WIRING GROMMET

One rectangular black or one antique brass grommet in a standard position is optional at no charge. Please note grommet choice clearly on order form. Additional grommets are available at an upcharge of \$125 list.

# STRATFORD | LINKING UNITS & CORNER UNITS

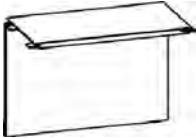
Description	Model	Cherry Walnut	W	D	H	KW	Shipping Weight	Cubic Feet
	98LU3620H	1365	34.75	19.75	30.5		15	3
	98LU3624H	1407	34.75	23.75	30.5		16	3
	98LU4220H	1426	38.75	19.75	30.5		20	4
	98LU4224H*	1474	38.75	23.75	30.5		24	4
	98LU4820H	1504	44.75	19.75	30.5		29	4
	98LU4824H	1536	44.75	23.75	30.5		36	4

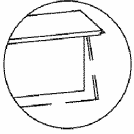

### ORDERING NOTES:

Please note on order if picture frame molding is required on hinged modesty panel. Laminate worksurfaces are available at a 10% upcharge.

For wire management cut out option on modesty panel add \$174 list upcharge.

For hinged modesty panel upcharge add 10% and insert Y after the LU in the model number. e.g. 98LUY4224H

Description	Model	Cherry Walnut	W	D	H	KW	Shipping Weight	Cubic Feet
	98LT3620H	676	34.75	19.75	1.25		15	2
	98LT3624H	685	34.75	23.75	1.25		16	2
	98LT4220H	703	38.75	19.75	1.25		20	2
	98LT4224H*	725	38.75	23.75	1.25		24	2
	98LT4820H	741	44.75	19.75	1.25		29	2
	98LT4824H	756	44.75	23.75	1.25		36	3

### ORDERING NOTES:

Laminate worksurfaces are available at a 10% upcharge.

Description	Model	Cherry Walnut	W	D	H	KW	Shipping Weight	Cubic Feet
	98CU363620	2671	35.75	35.75	30.5	22.5	106	33
	98CU363624*	2671	35.75	35.75	30.5	17	106	33
	98CU424224	2935	41.75	41.75	30.5	25.5	131	41

### ORDERING NOTES:

Laminate worksurfaces are available at a 10% upcharge. The x dimension on the 98CU363624 corner unit does not allow for an undersurface mounted keyboard or pencil drawer. Please specify a 98KBAC2110 with an extended mechanism if keyboard is required. See page 869.

### DIMENSION KEY

W – width  
D – depth  
H – height of worksurface  
KW – kneehole width

Dimensions are in inches and approximate.  
Contact Customer Service if dimensions are critical.

\*See page 5 for KrugExpress program.

### CODE DESCRIPTION

4 - full height pedestals  
D - 2 file drawer  
F - 2 box, 1 file drawer  
L - left hand support position  
R - right hand support position  
CU - corner unit  
LT - linking top  
Lu - linking unit

### STANDARD FINISHES

For a complete list of standard wood finishes please see page 772.

### WIRING GROMMET

One rectangular black or one antique brass grommet in a standard position is optional at no charge. Please note grommet choice clearly on order form. Additional grommets are available at an upcharge of \$125 list.

# STRATFORD | CREDENZAS

Description	Model	Cherry Walnut	W	D	H	Shipping Weight	Cubic Feet
Credenza Shells	98S6624LOR0*	2160	65.75	23.75	30.5	121	32
	98S7224LOR0	2356	71.75	23.75	30.5	137	35
	98S7824LOR0	2560	77.75	23.75	30.5	153	38

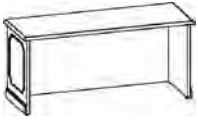

Description	Model	Cherry Walnut	W	D	H	Shipping Weight	Cubic Feet
Single Pedestal Credenza	98C66204LDR0	3778	65.75	19.75	30.5	163	33
	98C66204LFR0	3778	65.75	19.75	30.5	163	33
	98C66204LORD	3778	65.75	19.75	30.5	163	33
	98C66204LORF	3778	65.75	19.75	30.5	163	33
	98C66244LDR0	3779	65.75	23.75	30.5	171	38
	98C66244LFR0	3779	65.75	23.75	30.5	171	38
	98C66244LORF	3779	65.75	23.75	30.5	171	38
	98C72204LDR0	3779	65.75	23.75	30.5	171	38
	98C72204LFR0	3810	71.75	19.75	30.5	179	36
	98C72204LORD	3810	71.75	19.75	30.5	179	36
	98C72204LORF	3810	71.75	19.75	30.5	179	36
	98C72244LDR0	3810	71.75	19.75	30.5	179	36
	98C72244LFR0	3839	71.75	23.75	30.5	187	41
	98C72244LORD	3839	71.75	23.75	30.5	187	41
	98C72244LORF	3839	71.75	23.75	30.5	187	41
	98C72244LFR0	3839	71.75	23.75	30.5	187	41
	98C78204LDR0*	3821	77.75	19.75	30.5	195	38
	98C78204LFR0	3821	77.75	19.75	30.5	195	38
	98C78204LORD	3821	77.75	19.75	30.5	195	38
	98C78204LORF	3821	77.75	19.75	30.5	195	38
	98C78244LDR0	3821	77.75	23.75	30.5	203	44
	98C78244LFR0	3821	77.75	23.75	30.5	203	44
	98C78244LORD	3821	77.75	23.75	30.5	203	44
	98C78244LORF	3821	77.75	23.75	30.5	203	44
	98C84204LDR0	3842	83.75	19.75	30.5	211	41
	98C84204LFR0	3842	83.75	19.75	30.5	211	41
	98C84204LORD	3842	83.75	19.75	30.5	211	41
	98C84204LORF	3842	83.75	19.75	30.5	211	41
98C84244LDR0	3859	83.75	23.75	30.5	219	48	
98C84244LFR0	3859	83.75	23.75	30.5	219	48	
98C84244LORD	3859	83.75	23.75	30.5	219	48	
98C84244LORF	3859	83.75	23.75	30.5	219	48	

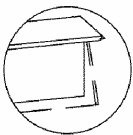
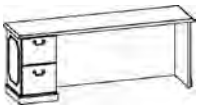

### ORDERING NOTES:

Please note on order if picture frame molding is required on hinged modesty panel. Laminate worksurfaces are available at a 10% upcharge. For wire management cut out option on modesty panel add \$174 list upcharge. For hinged modesty panel add a 10% upcharge and insert Y after the C in the model number. e.g. 98CY72244LORF

### ORDERING PROCEDURES

To order, please specify the following:

- 1) Krug product model number
- 2) Wood species and finish, see page 841
- 4) Pull style and finish, see page 845
- 5) Grommet location and style if applicable

\* Indicates model illustrated by line drawing

### CODE DESCRIPTION

- 0 - no pedestal
- 4 - full height pedestals
- D - 2 file drawer
- F - 2 box, 1 file drawer
- L - left hand support position
- R - right hand support position
- CD - center drawer
- OT - oversized top option
- BT - bow top option
- CC - corner credenza

### STANDARD FINISHES

For a complete list of standard wood finishes please see page 772.

### WIRING GROMMET

One rectangular black or one antique brass grommet in a standard position is optional at no charge. Please note grommet choice clearly on order form. Additional grommets are available at an upcharge of \$125 list.

# STRATFORD | CREDENZAS

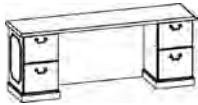
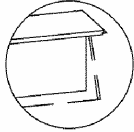
Description	Model	Cherry Walnut					Shipping Weight	Cubic Feet
			W	D	H	KW		
Double Pedestal Credenza	98C66204LDRD	4058	65.75	19.75	30.5	31.5	198	33
	98C66204LDRF	4058	65.75	19.75	30.5	31.5	198	33
 	98C66204LFRD	4058	65.75	19.75	30.5	31.5	198	33
	98C66204LFRF	4058	65.75	19.75	30.5	31.5	198	33
	98C66244LDRD	4066	65.75	23.75	30.5	31.5	211	38
	98C66244LDRF	4066	65.75	23.75	30.5	31.5	211	38
	98C66244LFRD	4066	65.75	23.75	30.5	31.5	211	38
	98C66244LFRF	4066	65.75	23.75	30.5	31.5	211	38
	98C72204LDRD	4101	71.75	19.75	30.5	37.5	214	36
	98C72204LDRF	4101	71.75	19.75	30.5	37.5	214	36
	98C72204LFRD	4101	71.75	19.75	30.5	37.5	214	36
	98C72204LFRF	4101	71.75	19.75	30.5	37.5	214	36
	98C72244LDRD	4129	71.75	23.75	30.5	37.5	227	41
	98C72244LDRF	4129	71.75	23.75	30.5	37.5	227	41
	98C72244LFRD	4129	71.75	23.75	30.5	37.5	227	41
	98C72244LFRF	4129	71.75	23.75	30.5	37.5	227	41
	98C78204LDRD*	4167	77.75	19.75	30.5	43.5	230	38
	98C78204LDRF	4167	77.75	19.75	30.5	43.5	230	38
	98C78204LFRD	4167	77.75	19.75	30.5	43.5	230	38
	98C78204LFRF	4167	77.75	19.75	30.5	43.5	230	38
	98C78244LDRD	4204	77.75	23.75	30.5	43.5	243	44
	98C78244LDRF	4204	77.75	23.75	30.5	43.5	243	44
98C78244LFRD	4204	77.75	23.75	30.5	43.5	243	44	
98C78244LFRF	4204	77.75	23.75	30.5	43.5	243	44	
98C84204LDRD	4210	83.75	19.75	30.5	49.5	246	41	
98C84204LDRF	4210	83.75	19.75	30.5	49.5	246	41	
98C84204LFRD	4210	83.75	19.75	30.5	49.5	246	41	
98C84204LFRF	4210	83.75	19.75	30.5	49.5	246	41	
98C84244LDRD	4221	83.75	23.75	30.5	49.5	259	48	
98C84244LDRF	4221	83.75	23.75	30.5	49.5	259	48	
98C84244LFRD	4221	83.75	23.75	30.5	49.5	259	48	
98C84244LFRF	4221	83.75	23.75	30.5	49.5	259	48	

### ORDERING NOTES:

Please note on order if picture frame molding is required on hinged modesty panel. Laminate worksurfaces are available at a 10% upcharge.

For wire management cut out option on modesty panel add \$174 list upcharge.

For hinged modesty panel add a 10% upcharge and insert Y after the C in the model number. e.g. 98CY7224LFRF

### DIMENSION KEY

W — width  
D — depth  
H — height of worksurface  
KW— kneehole width

Dimensions are in inches and approximate.  
Contact Customer Service if dimensions are critical.

\*See page 5 for KrugExpress program.

### CODE DESCRIPTION

0 - no pedestal  
4 - full height pedestals  
D - 2 file drawer  
F - 2 box, 1 file drawe  
L - left hand support position  
R - right hand support position  
CD - center drawer  
OT - oversized top option  
BT - bow top option  
CC - corner credenza

### STANDARD FINISHES

For a complete list of standard wood finishes please see page 772.

### WIRING GROMMET

One rectangular black or one antique brass grommet in a standard position is optional at no charge. Please note grommet choice clearly on order form. Additional grommets are available at an upcharge of \$125 list.

# STRATFORD | CREDENZAS

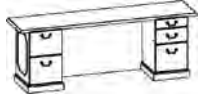
Description	Model	Cherry		W	D	H	Shipping Weight	Cubic Feet
		Walnut						
 Oversized Top Option	OT98C6620	251		71.75	19.75	-	15	-
	OT98C6624	251		71.75	23.75	-	15	-
	OT98C7220	251		77.75	19.75	-	15	-
	OT98C7224	251		77.75	23.75	-	15	-
	OT98C7820*	251		83.75	19.75	-	15	-
	OT98C7824	251		83.75	23.75	-	15	-

## ORDERING NOTES:

In the 20" deep knee hole credenzas and/or shells the pencil drawer cannot be used. The oversized top option is only available on stand-alone double pedestal credenzas and cannot be used in conjunction with any other run-off connecting worksurfaces. Specifying the oversized top option increases the top width, increasing the left and right overhang measurement to 4 1/2". The front and rear overhang remains unchanged. Laminate worksurfaces are available at a 10% upcharge.

Description	Model	Price	Cherry		W	D	H	Shipping Weight	Cubic Feet
			Walnut						
 Lateral File or Bookcase Pedestal	98C6620LBR0	3450	65.75	19.75	30.5	25.75	204	33	
	98C6620LFR0	3450	65.75	19.75	30.5	25.75	212	33	
	98C6620LORB	3450	65.75	19.75	30.5	25.75	204	33	
	98C6620LORF	3450	65.75	19.75	30.5	25.75	212	33	
	98C6624LBR0	3518	65.75	23.75	30.5	25.75	211	38	
	98C6624LFR0	3518	65.75	23.75	30.5	25.75	227	38	
	98C6624LORB	3518	65.75	23.75	30.5	25.75	211	38	
	98C6624LORF	3518	65.75	23.75	30.5	25.75	227	38	
	98C7220LBR0	3596	71.75	19.75	30.5	31.75	228	36	
	98C7220LFR0	3596	71.75	19.75	30.5	31.75	236	36	
	98C7220LORB	3596	71.75	19.75	30.5	31.75	228	36	
	98C7220LORF	3596	71.75	19.75	30.5	31.75	236	36	
	98C7224LBR0	3675	71.75	23.75	30.5	31.75	235	41	
	98C7224LFR0	3675	71.75	23.75	30.5	31.75	243	41	
	98C7224LORB	3675	71.75	23.75	30.5	31.75	235	41	
	98C7224LORF	3675	71.75	23.75	30.5	31.75	243	41	
	98C8420LBR0	3777	83.75	19.75	30.5	43.75	256	41	
	98C8420LFR0	3777	83.75	19.75	30.5	43.75	268	41	
	98C8420LORB	3777	83.75	19.75	30.5	43.75	256	41	
	98C8420LORF	3777	83.75	19.75	30.5	43.75	268	41	
98C8424LBR0	3857	83.75	23.75	30.5	43.75	267	48		
98C8424LFR0	3857	83.75	23.75	30.5	43.75	275	48		
98C8424LORB	3857	83.75	23.75	30.5	43.75	267	48		
98C8424LORF*	3857	83.75	23.75	30.5	43.75	275	48		

## ORDERING NOTES:

Please note on order if picture frame molding is required on hinged modesty panel. Laminate worksurfaces are available at a 10% upcharge. Bookcase pedestals include one adjustable shelf. For hinged modesty panel add a 10% upcharge and insert Y after the C in the model number. e.g. 98CY7224LORF

### ORDERING PROCEDURES

To order, please specify the following:

- 1) Krug product model number
- 2) Wood species and finish, see page 841
- 4) Pull style and finish, see page 845
- 5) Grommet location and style if applicable

\* Indicates model illustrated by line drawing

### CODE DESCRIPTION

- 0 - no pedestal
- 4 - full height pedestals
- D - 2 file drawer
- F - 2 box, 1 file drawer
- L - left hand support position
- R - right hand support position
- CD - center drawer
- OT - oversized top option
- BT - bow top option
- CC - corner credenza

### STANDARD FINISHES



For a complete list of standard wood finishes please see page 772.

### WIRING GROMMET

One rectangular black or one antique brass grommet in a standard position is optional at no charge. Please note grommet choice clearly on order form. Additional grommets are available at an upcharge of \$125 list.

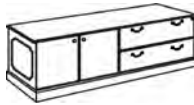

# STRATFORD | CREDENZAS

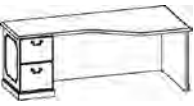
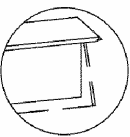
Description	Model	Cherry Walnut	W	D	H	KW	Shipping Weight	Cubic Feet
	98C6320LFRF	4955	62.5	19.75	30.5		304	27
	98C6324LFRF	4979	62.5	23.75	30.5		316	27
	98C7220LBRF	5066	71.75	19.75	30.5		320	29
	98C7220LFRB	5066	71.75	19.75	30.5		320	29
	98C7224LBRF*	5163	71.75	23.75	30.5		331	35
	98C7224LFRB	5159	71.75	23.75	30.5		331	35
	98C7520LFRF	5666	74.5	19.75	30.5		334	37
	98C7524LFRF	5719	74.5	23.75	30.5		347	37
	98C66204FBCF	4656	65.75	19.75	30.5	25.75	250	33
	98C66204DBCD	4656	65.75	19.75	30.5	25.75	246	33
	98C66244FBCF	4734	65.75	23.75	30.5	25.75	263	38
	98C72204FBCF	4734	65.75	23.75	30.5	25.75	259	38
	98C72204DBCD	4876	71.75	19.75	30.5	25.75	266	36
	98C72244FBCF*	4876	71.75	19.75	30.5	25.75	262	36
	98C72244DBCD	5013	71.75	23.75	30.5	25.75	279	41
	98C84204FBCF	5013	71.75	23.75	30.5	25.75	275	41
	98C84204DBCD	5157	83.75	19.75	30.5	31.75	298	41
	98C84204DBCD	5157	83.75	19.75	30.5	31.75	294	41
	98C84244FBCF**	5297	83.75	23.75	30.5	31.75	311	48
	98C84244DBCD	5297	83.75	23.75	30.5	31.75	307	48
 	98CC6624L4D	3242	65.75	35.75	30.5	37.5	184	55
	98CC6624R4D	3242	65.75	35.75	30.5	20.5	184	55
	98CC6624L4F	3242	65.75	35.75	30.5	20.5	184	55
	98CC6624R4F	3242	65.75	35.75	30.5	20.5	184	55
	98CC7224L4D*	3320	71.75	35.75	30.5	20.5	202	60
	98CC7224R4D	3320	71.75	35.75	30.5	20.5	202	60
	98CC7224L4F	3320	71.75	35.75	30.5	20.5	202	60
	98CC7224R4F	3320	71.75	35.75	30.5	20.5	202	60
	98CC7824L4D	3357	77.75	35.75	30.5	20.5	210	64
	98CC7824R4D	3357	77.75	35.75	30.5	20.5	210	64
	98CC7824L4F	3357	77.75	35.75	30.5	20.5	210	64
	98CC7824R4F	3357	77.75	35.75	30.5	20.5	210	64
	98CC8424L4D	3393	83.75	35.75	30.5	20.5	218	69
	98CC8424R4D	3393	83.75	35.75	30.5	20.5	218	69
	98CC8424L4F	3393	83.75	35.75	30.5	20.5	218	69
98CC8424R4F	3393	83.75	35.75	30.5	20.5	218	69	

## ORDERING NOTES:

Corner credenzas allow for a 24" deep unit at the connecting end. Laminate worksurfaces are available at a 10% upcharge. For wire management cut out option on modesty panel add \$174 list upcharge. For hinged modesty panel add a 10% upcharge and insert Y after the C in the model number. e.g. 98CY7224LORF

### DIMENSION KEY

W — width  
D — depth  
H — height of worksurface  
KW— kneehole width

Dimensions are in inches and approximate.  
Contact Customer Service if dimensions are critical.

\*See page 5 for KrugExpress program.

### CODE DESCRIPTION

0 - no pedestal  
4 - full height pedestals  
D - 2 file drawer  
F - 2 box, 1 file drawe  
L - left hand support position  
R - right hand support position  
CD - center drawer  
OT - oversized top option  
BT - bow top option  
CC - corner credenza

### STANDARD FINISHES

For a complete list of standard wood finishes please see page 772.

### WIRING GROMMET

One rectangular black or one antique brass grommet in a standard position is optional at no charge. Please note grommet choice clearly on order form. Additional grommets are available at an upcharge of \$125 list.

# STRATFORD | OVERHEADS

Description	Model	Cherry Walnut	W	D	H	Shipping	
						Weight	Cubic Feet
Overheads with Wood Doors   *	98OH3616*	1504	35.75	16	16	53	8
	98OH4216	1599	41.75	16	16	57	9
	98OH4816	1661	47.75	16	16	77	10
	98OH5416	1797	53.75	16	16	81	11
	98OH6016	1937	59.75	16	16	88	12
	98OH6616**	2043	65.75	16	16	94	13
	98OH7216	2151	71.75	16	16	99	14

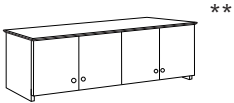

## Tackboards Grades

Description	Model										W	H	COM WT	
		1	2	3	4	5	6	7	8	9				
Tackboards for use with Overheads  	69TBOH36	246	268	293	333	437	535	635	735	962	34	26	1.5	11
	69TBOH42	256	278	300	338	437	530	624	722	937	41.75	26	1.5	12
	69TBOH48	283	351	369	462	555	636	732	842	1057	47.75	26	1.75	13
	69TBOH54	291	382	417	532	621	713	819	926	1139	55.75	26	1.75	14
	69TBOH60	320	428	450	561	670	797	919	1048	1260	61.75	26	2	15
	69TBOH66	352	478	472	654	785	935	1061	1212	1439	67.75	26	2	16
	69TBOH72	387	591	616	816	1004	1016	1167	1333	1546	74.75	26	2.25	19

### ORDERING PROCEDURES

To order, please specify the following:

- 1) Krug product model number
- 2) Wood species and finish, see page 841
- 4) Pull style and finish, see page 845
- 5) Grommet location and style if applicable

\* Indicates model illustrated by line drawing

### CODE DESCRIPTION

OH - overhead unit  
 W - includes power/data/voice grommet  
 G - includes glass doors  
 Z - includes grill doors  
 PM - paper manager  
 TBOH- tackboard for overhead

### STANDARD FINISHES

For a complete list of standard wood finishes please see page 772.

### OVERHEADS

All overheads include installed tasklights and mounting hardware. Contact customer service for information about flush units. Tackboards must be ordered separately.

# STRATFORD | HUTCHES

Description	Model	Cherry Walnut	W	D	H	KW	Shipping Weight	Cubic Feet
5-Hi Hutch with Wood Doors	98HT601640	3015	59.75	16	40	23.5	150	26
	98HT661640*	3296	65.75	16	40	23.5	162	28
	98HT721640	3870	71.75	16	40	23.5	174	31
	98HT781640	4103	77.75	16	40	23.5	186	33
	98HT841640	4332	83.75	16	40	23.5	200	36

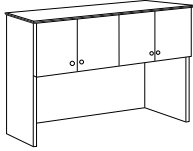

6-Hi Hutch with Wood Doors	98HT601653	3666	59.75	16	53	23.5	200	34
	98HT661653*	4071	65.75	16	53	23.5	212	37
	98HT721653	4660	71.75	16	53	23.5	224	41
	98HT781653	5013	77.75	16	53	23.5	236	44
	98HT841653	5372	83.75	16	53	23.5	250	47

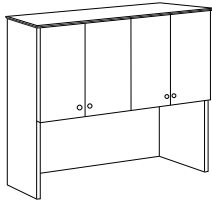

### ORDERING NOTES:

Hutches are inset 1-1/2" on each side when sitting on the worksurface. Locks are available on wood door hutches and overheads at \$116 list per set of (2) doors.

6-Hi Hutch with Wood Doors	98HT601653G	3884	59.75	16	53	23.5	117	34
	98HT661653G*	4313	65.75	16	53	23.5	126	37
	98HT721653G	4938	71.75	16	53	23.5	135	41
	98HT781653G	5318	77.75	16	53	23.5	146	44
	98HT841653G	5693	83.75	16	53	23.5	154	47

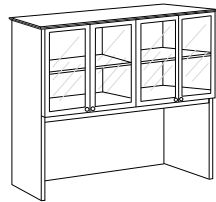

### ORDERING NOTES:

All shelves in glass door hutches are 1/4" thick glass. Hutches are inset 1-1/2" on each side when sitting on the worksurface.

6-Hi Hutch with Grill Doors	98HT601653Z	4419	59.75	16	53	23.5	150	34
	98HT661653Z*	4825	65.75	16	53	23.5	162	37
	98HT721653Z	5415	71.75	16	53	23.5	174	41
	98HT781653Z	5767	77.75	16	53	23.5	186	44
	98HT841653Z	6125	83.75	16	53	23.5	200	47



### ORDERING NOTES:

All shelves in grill door hutches are 1/4" thick glass. This Hutch includes a factory installed tasklight and a tackboard in Grade 1 fabric. Grill doors are NOT available on KrugExpress. Hutches are inset 1-1/2" on each side when sitting on the worksurface.

### DIMENSION KEY

W — width  
D — depth  
H — height of worksurface  
KW — kneehole width

Dimensions are in inches and approximate. Contact Customer Service if dimensions are critical.

\*See page 5 for KrugExpress program.

### CODE DESCRIPTION

OH - overhead unit  
W - includes power/data/voice grommet  
G - includes glass doors  
Z - includes grill doors  
PM - paper manager  
TBOH- tackboard for overhead

### STANDARD FINISHES

For a complete list of standard wood finishes please see page 772.

### HUTCHES

Hutches include tasklights and a tackboard in grade 1 fabric. See page 855 for upcharges for grades 2-9.

# STRATFORD | HUTCHES

Description	Model	Cherry Walnut				Shipping Weight	Cubic Feet
			W	D	H		
6-Hi Full Height Hutch with Clear Glass Doors	98HT60165301G	4273	59.75	16	53	200	34
	98HT66165301G*	4743	65.75	16	53	212	37
	98HT72165301G	5431	71.75	16	53	224	41
	98HT78165301G	5847	77.75	16	53	232	44
	98HT84165301G	6262	83.75	16	53	250	47

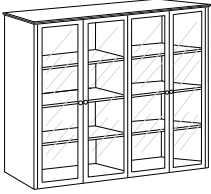

**ORDERING NOTES:**

All shelves in glass door hutches are 1/4" thick glass. Hutches are inset 1-1/2" on each side when sitting on the worksurface.

6-Hi Full Height Hutch with Grill Doors	98HT60165301Z	5010	59.75	16	53	190	34
	98HT66165301Z*	5306	65.75	16	53	202	37
	98HT72165301Z	5956	71.75	16	53	212	41
	98HT78165301Z	6345	77.75	16	53	222	44
	98HT84165301Z	6734	83.75	16	53	240	47

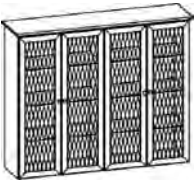

**ORDERING NOTES:**

All shelves in grill door hutches are 1/4" thick glass. Grill doors are NOT available on KrugExpress. Hutches are inset 1-1/2" on each side when sitting on the worksurface.

Paper Managers	98PM18132001	1456	16.5	13	19.5	15	4
----------------	--------------	------	------	----	------	----	---



**ORDERING PROCEDURES**

To order, please specify the following:

- 1) Krug product model number
- 2) Wood species and finish, see page 841
- 4) Pull style and finish, see page 845
- 5) Grommet location and style if applicable

\* Indicates model illustrated by line drawing

**CODE DESCRIPTION**

- OH - overhead unit
- W - includes power/data/voice grommet
- G - includes glass doors
- Z - includes grill doors
- PM - paper manager
- TBOH- tackboard for overhead

**STANDARD FINISHES**

For a complete list of standard wood finishes please see page 772.

**HUTCHES**

Hutches include tasklights and a tackboard in grade 1 fabric. See page 804 for upcharges for grades 2-9.

## Hutch tackboard upgrade chart

Use this chart to find the upcharge for tackboard fabrics graded 2-9 and add it to the cost of the hutch. Fabric grades can be referenced on page xx.

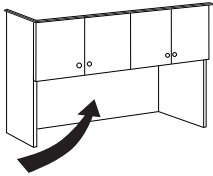

Pot light option for Hutches

	FABRIC GRADES									
	2	3	4	5	6	7	8	9	COM	
65" hutch tackboard	113	239	347	464	574	686	800	1045	2	
71" hutch tackboard	124	270	395	524	653	779	901	1147	2.25	
78" hutch tackboard	150	320	472	633	782	932	1084	1332	2.5	
84" hutch tackboard	180	378	593	783	978	1143	1229	1478	2.5	
91" hutch tackboard	212	437	646	857	1064	1143	1483	1733	2.75	
Pot Light	391	Per hutch (includes two lights)								

### ORDERING NOTES :

The factory installed pot light option is available on any glass door or grill door hutch. The two lights are mounted through the hutch top and activated by a switch located on the light inside the case. Please add the upcharge shown above to hutch price and specify pot light option on your order. This item is not available on KrugExpress.

On single piece hutches, the yardage requirement for two tackboards is the same as for one tackboard. Please keep this in mind when ordering more than one tackboard. For example, if the number of tackboards required is 7 and the COM requirement for 1 tackboard is 1.5 yards, the calculation for COM yardage is as follows: 4.5 yards are required for 6 tackboards + 1.5 yards for the 7th tackboard for a total of 6 yards. In the case of an even number of tackboards, divide the number of tackboards required by 2 and multiply that number by the COM requirement on the chart. The fabric must be at least 54" wide in order to qualify for this procedure. If the fabric is less than 54" wide, the COM yardage listed on the chart is the amount required for each tackboard.

### COM yardage Calculation Chart of Tackboards

Quantity of Tackboards Required (example: 60")	Number of yards Required per Tackboard (example: 60")	Number of yards Required in Total (example: 60")
one	2 yards	2
two	2 yards	2
three	2 yards	4
four	2 yards	4
fiv	2 yards	6
six	2 yards	6
seven	2 yards	8
eight	2 yards	8
nine	2 yards	10
ten	2 yards	10

#### DIMENSION KEY

W — width  
 D — depth  
 H — height of worksurface  
 KW— kneehole width

Dimensions are in inches and approximate.  
 Contact Customer Service if dimensions are critical.

\*See page 5 for KrugExpress program.

#### CODE DESCRIPTION

PM — paper manager

# STRATFORD | KEYBOARDS & PENCIL DRAWERS

Description	Model	Cherry Walnut	W	D	H	Shipping Weight	Cubic Feet
Articulating Keyboard Tray with Palm Rest and Mouse Tray/Extended Mechanism	98KBAMT1912	565	-	-	-	20	2

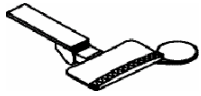

**ORDERING NOTES:**

This unit comes with a lever free arm keyboard support. This unit is a granite color.

Pencil Drawer	98PD2116	480	-	-	-	2	1
---------------	----------	-----	---	---	---	---	---

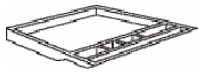

Wire Management Cover	98WM72	120	-	-	-	3	7
-----------------------	--------	-----	---	---	---	---	---



Velcro Wire Management	98WM4	33	-	-	-	1	1
------------------------	-------	----	---	---	---	---	---



Grommets	98PDVM	174	-	-	-	1	1
----------	--------	-----	---	---	---	---	---



**ORDERING NOTES:**

This grommet is only available in black.

**ORDERING PROCEDURES**

To order, please specify the following:

- 1) Krug product model number
- 2) Wood species and finish, see page 841
- 4) Pull style and finish, see page 845
- 5) Grommet location and style if applicable

\* Indicates model illustrated by line drawing

**CODE DESCRIPTION**

PD - pencil drawer  
 WM - wire management  
 PDVM - power/data/voice grommet

**STANDARD FINISHES**

For a complete list of standard wood finishes please see page 772.

**BRASS FINISH**

Standard grommets and pop-up grommets are available in black or brass finishes.

# STRATFORD | MODULAR COMPONENTS

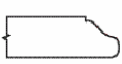
Description	Model	Cherry			W	D	H	Shipping Weight	Cubic Feet
		Walnut							
 	Tops for 2-Hi Modular Storage	98TP6020	960		59.75	19.75	29.25	45	2
		98TP6024	1015		59.75	23.75	1.25	52	2
		98TP6320	1035		62.75	19.75	1.25	48	2
		98TP6324	1049		62.75	23.75	1.25	51	3
		98TP6620*	1063		65.75	19.75	1.25	53	3
		98TP6624	1112		65.75	23.75	1.25	61	3
		98TP6920	1130		68.75	19.75	1.25	57	3
		98TP6924	1151		68.75	23.75	1.25	61	3
		98TP7220	1163		71.75	19.75	1.25	63	3
		98TP7224	1205		71.75	23.75	1.25	65	3
		98TP7520	1214		74.75	19.75	1.25	67	3
		98TP7524	1242		74.75	23.75	1.25	70	3
		98TP7820	1253		77.75	19.75	1.25	71	3
		98TP7824	1298		77.75	23.75	1.25	73	3
		98TP8420	1338		83.75	19.75	1.25	76	3
		98TP8424	1379		83.75	23.75	1.25	78	4
		98TP9020	1418		89.75	19.75	1.25	81	3
		98TP9024	1458		89.75	23.75	1.25	86	4
		98TP9220	1469		91.75	19.75	1.25	85	3
		98TP9224	1490		91.75	23.75	1.25	89	4
	98TP9620	1496		95.75	19.75	1.25	88	4	
	98TP9624	1540		95.75	23.75	1.25	92	4	

### ORDERING NOTES:

A half gable is required on any open span greater than 48" that does not have a modesty panel. Standard 98TP tops have profile on the ee sides. They are designed to be flush on the back edge

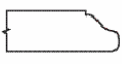
Description	Model	Cherry			W	D	H	Shipping Weight	Cubic Feet
		Walnut							
 	Tops with one Coved End	98TPR6020L	960		59.75	19.75	1.25	45	2
		98TPR6020R	960		59.75	19.75	1.25	45	2
		98TPR6024L	1015		59.75	23.75	1.25	52	3
		98TPR6024R	1015		59.75	23.75	1.25	52	3
		98TPR6620L	1063		65.75	19.75	1.25	53	3
		98TPR6620R*	1063		65.75	19.75	1.25	53	3
		98TPR6624L	1112		65.75	23.75	1.25	61	3
		98TPR6624R	1112		65.75	23.75	1.25	61	3
		98TPR7220L	1163		71.75	19.75	1.25	63	3
		98TPR7220R	1163		71.75	19.75	1.25	63	3
		98TPR7224L	1205		71.75	23.75	1.25	65	3
		98TPR7224R	1205		71.75	23.75	1.25	65	3

### ORDERING NOTES:

A half gable is required on any open span greater than 48" that does not have a modesty panel. Standard 98TP tops have profile on the ee sides. They are designed to be flush on the back edge

### DIMENSION KEY

W — width  
D — depth  
H — height of worksurface  
KW— kneehole width

Dimensions are in inches and approximate. Contact Customer Service if dimensions are critical.

\*See page 5 for KrugExpress program.

### CODE DESCRIPTION

TP - modular top with standard profil  
TPR - modular top for run-offs with one coved connecting end  
TPI - modular top with inverted profil  
ST - freestanding storage  
STM - modular storage  
WRM - modular wardrobe  
G - includes glass doors  
D - 2 file drawer  
F - 2 box, 1 file drawe



### OPEN SPANS

It is not recommended that modular units be combined together to create open spans greater than 60".

### STORAGE

Freestanding storage has finished, profiled tops and base molding on three sides. Modular storage does not have finished tops (they must be ordered separately) and base molding is only across the front.

# STRATFORD | MODULAR COMPONENTS

Description	Model	Cherry		W	D	H	Shipping Weight	Cubic Feet
		Walnut						
Tops with one Coved End, Continued  	98TPR7820L	1253		77.75	19.75	1.25	71	3
	98TPR7820R	1253		77.75	19.75	1.25	71	3
	98TPR7824L	1298		77.75	23.75	1.25	73	3
	98TPR7824R	1298		77.75	23.75	1.25	73	3
	98TPR8420L	1338		83.75	19.75	1.25	76	3
	98TPR8420R	1338		83.75	19.75	1.25	76	3
	98TPR8424L*	1379		83.75	23.75	1.25	78	4
	98TPR8424R	1379		83.75	23.75	1.25	78	4
	98TPR9020L	1418		89.75	19.75	1.25	81	3
	98TPR9020R	1418		89.75	19.75	1.25	86	3
	98TPR9024L	1458		89.75	23.75	1.25	86	4
	98TPR9024R	1458		89.75	23.75	1.25	86	4
	98TPR9620L	1496		95.75	19.75	1.25	88	4
	98TPR9620R	1496		95.75	19.75	1.25	88	4
	98TPR9624L	1540		95.75	23.75	1.25	92	4
	98TPR9624R	1540		95.75	23.75	1.25	92	4

### ORDERING NOTES:

A half gable is required on any open span greater than 48" that does not have a modesty panel. Standard 98TP tops have profile on the e sides. They are designed to be flush on the back edge

Modular Pedestal	Model	Cherry		W	D	H	Shipping Weight	Cubic Feet
		Walnut						
 *	98P1620304D**	1494		15.75	19.75	29.25	68	6
	98P1624304D	1608		15.75	23.75	29.25	73	8
	98P1620304F*	1603		15.75	19.75	29.25	70	6
	98P1624304F	1716		15.75	23.75	29.25	75	8

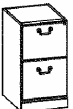

### ORDERING NOTES:

Modular storage units do not have finished tops and are intended to be combined with 98TP tops. Modular storage unit backs are finished. It is not recommended that modular units be combined together to create open spans greater than 60".

### ORDERING PROCEDURES

To order, please specify the following:

- 1) Krug product model number
- 2) Wood species and finish, see page 841
- 4) Pull style and finish, see page 845
- 5) Grommet location and style if applicable

\* Indicates model illustrated by line drawing

### CODE DESCRIPTION

TP - modular top with standard profil  
 TPR - modular top for run-offs with one coved connecting end  
 TPI - modular top with inverted profil  
 ST - freestanding storage  
 STM - modular storage  
 WRM - modular wardrobe  
 G - includes glass doors  
 D - 2 file drawer  
 F - 2 box, 1 file drawe

### STANDARD FINISHES

For a complete list of standard wood finishes please see page 772.

### STORAGE

Freestanding storage has finished, profiled tops and base molding on three sides. Modular storage does not have finished tops (they must be ordered separately) and base molding is only across the front.



# STRATFORD | MODULAR COMPONENTS

Description	Model	Cherry Walnut			Shipping Weight	Cubic Feet	
		W	D	H			
Modular Bookcase Pedestal	98STM30203011	1709	29.75	19.75	29.25	105	13
	98STM36203011	1819	35.75	19.75	29.25	109	15
	98STM30243011*	1761	29.75	19.75	29.25	113	15
	98STM36243011	1878	35.75	19.75	29.25	117	18

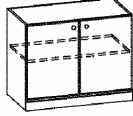

**ORDERING NOTES:**

Modular storage units do not have finished tops and are intended to be combined with 98TP tops. Modular storage unit backs are finished. Locks may be added to the bookcase doors at a \$116 list upcha ge.

Modular Lateral File Pedestal	98STM30203001	2041	29.75	19.75	29.25	113	13
	98STM36203001	2155	35.75	19.75	29.25	117	15
	98STM30243001*	2099	29.75	19.75	29.25	121	15
	98STM36243001	2217	35.75	19.75	29.25	129	18



**ORDERING NOTES:**

Modular storage units do not have finished tops and are intended to be combined with 98TP tops. Modular storage unit backs are finished

Half Gable	98HG2710	362	10	27	27	11	1
	98HG2716	412	16	27	27	16	1

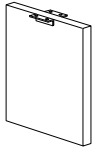

**ORDERING NOTES:**

This unit should be ordered to center-support open spans greater than 60". Use 98HG2710 with 20" & 24" deep cases and 98HG2716 with 30" deep cases.

Modular End Panel Support	98LB2030L	674	12	19.75	29.25	35	2
	98LB2430L*	707	12	23.75	29.25	37	2
	98LB2030R	674	12	19.75	29.25	35	2
	98LB2430R	707	12	23.75	29.25	37	2



Modular Hinged Modesty Panel	98MPY72	682	37.5	-	30.5	42	3
	98MPY78*	709	43.5	-	30.5	50	3
	98MPY84	732	49.5	-	30.5	60	3

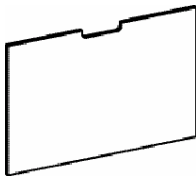

**DIMENSION KEY**

W — width  
D — depth  
H — height of worksurface  
KW— kneehole width

Dimensions are in inches and approximate. Contact Customer Service if dimensions are critical.

\*See page 5 for KrugExpress program.

**CODE DESCRIPTION**

TP - modular top with standard profil  
TPR - modular top for run-offs with one coved connecting end  
TPI - modular top with inverted profil  
ST - freestanding storage  
STM - modular storage  
WRM - modular wardrobe  
G - includes glass doors  
D - 2 file drawer  
F - 2 box, 1 file drawe

**STANDARD FINISHES**

For a complete list of standard wood finishes please see page 841.

**STORAGE**

Freestanding storage has finished, profiled tops and base molding on three sides. Modular storage does not have finished tops (they must be ordered separately) and base molding is only across the front.

# STRATFORD | MODULAR COMPONENTS

## Ordering modular storage with 98TP tops

30" high modular storage units are created by combining 98TP modular tops and modular bases. The top profile on a 98TP matches that of all other 30" high Stratford products including desks and credenzas. For example:

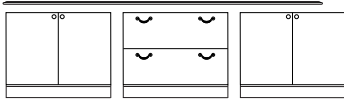

One 98TP-9224 modular top.  
Two 98STM-302430-11 modular bookcase pedestals.  
One 98STM-302430-01 modular lateral file pedestal.

The modular components can be used together to create a variety of custom storage.

## Ordering modular storage with 98TPR tops

30" high modular run-off units are created by combining 98TPR modular tops and modular bases.

For example:



One 98TPR-6624 modular top.  
One 98STM-302430-01 modular lateral file pedestal. One 98P-162430-4F modular B/B/F pedestal.

The modular components can be used together to create a variety of custom run-off units.

## Modular Top and Storage Flush Combinations

Use this guide of recommendations to create flush units with modular tops and storage.

TOP SIZE	PEDESTAL COMBINATIONS THAT FIT FLUSH	LEFT/RIGHT OVERHANG
<b>2-hi modular storage</b>		
98TP-63	(2) 30" wide pedestals	1 1/2"
98TP-69	(1) 30" wide pedestal and (1) 36" wide pedestal	1 1/2"
98TP-75	pedestal (2) 36" wide pedestals	1 1/2"
98TP-92	(3) 30" wide pedestals	1 1/2"

## ORDERING PROCEDURES

To order, please specify the following:

- 1) Krug product model number
- 2) Wood species and finish, see page 841
- 4) Pull style and finish, see page 845
- 5) Grommet location and style if applicable

\* Indicates model illustrated by line drawing

# STRATFORD | MODULAR COMPONENTS

Description	Model	Cherry Walnut	W	D	H	Shipping Weight	Cubic Feet
Top for 2-Hi Modular Bookcases	98TP7516	972	74.75	16	1.25	55	2

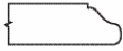

2-Hi Modular Bookcase	98BCM361630	1287	35.75	16	29.25	91	12
-----------------------	-------------	------	-------	----	-------	----	----



**ORDERING NOTES:**

Modular bookcases do not have finished tops and are intended to be combined with 98TP tops.

Ordering modular bookcases with 98TP tops  
30" high modular bookcases can be created by combining modular tops and bookcase units.

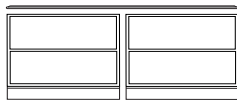

One 98TP-7516 modular top.  
Two 98BCM-3616-30 modular bookcases.

The modular components can be  
used together to create custom storage.

**DIMENSION KEY**

W — width  
D — depth  
H — height of worksurface  
KW— kneehole width

Dimensions are in inches and approximate.  
Contact Customer Service if dimensions are critical.

\*See page 5 for KrugExpress program.

**CODE DESCRIPTION**

G - includes glass doors  
BC - bookcase  
BCM- modular bookcase  
TPI- modular bookcase top

**STANDARD FINISHES**

For a complete list of standard wood finishes please see page 841.

# STRATFORD | MODULAR COMPONENTS

Description	Model	Cherry Walnut	W	D	H	Shipping Weight	Cubic Feet
 3-Hi Modular Bookcase Tops	98TPI6216-3HI	964	59.75	15.75	1.25	43	3
	98TPI7416-3HI	972	72.75	15.75	1.25	51	3
	98TPI9216-3HI*	978	89.75	15.75	1.25	79	4
	98TPI9716-3HI	987	95.75	15.75	1.25	92	4

 3-Hi Modular Bookcase Tops	98PRM301640	1423	29.5	15.75	39.25	120	22
	98PRM361640	1458	35.75	15.75	39.25	135	26

 3-Hi Modular Closed Bookcase Pier, No Base Molding	98PRM30164011	1709	29.5	15.75	39.25	135	22
	98PRM36164011	1771	35.75	15.75	39.25	150	26

## ORDERING PROCEDURES

To order, please specify the following:

- 1) Krug product model number
- 2) Wood species and finish, see page 841
- 4) Pull style and finish, see page 845
- 5) Grommet location and style if applicable

\* Indicates model illustrated by line drawing

## CODE DESCRIPTION

0 - no pedestal  
 4 - full height pedestals  
 D - 2 file drawer  
 F - 2 box, 1 file drawer  
 L - left hand support position  
 R - right hand support position  
 CD - center drawer  
 OT - oversized top option  
 BT - bow top option  
 CC - corner credenza

## STANDARD FINISHES

For a complete list of standard wood finishes please see page 772.

## STORAGE

Freestanding storage has finished, profiled tops and base molding on three sides. Modular storage does not have finished tops (they must be ordered separately) and base molding is only across the front.

# STRATFORD | MODULAR COMPONENTS

Description	Model	Cherry		W	D	H	Shipping Weight	Cubic Feet
		Walnut	972					
Top for 5-Hi Modular Bookcases	98TPI7416		972	73.75	16	1.25	55	2



**ORDERING NOTES:**

This bookcase has a 1" overhang on the left and right sides. There is no overhang on the back edge. Profil of 98TPI tops are inverted.

5-Hi Modular Bookcase	98BCM361671	1768	35.75	16	69.75	158	27
-----------------------	-------------	------	-------	----	-------	-----	----



**ORDERING NOTES:**

Modular bookcases do not have finished tops and are intended to be combined with 98TP tops.

Ordering modular bookcases with 98TPI tops  
71" high modular bookcases can be created by combining modular tops and bookcase units.

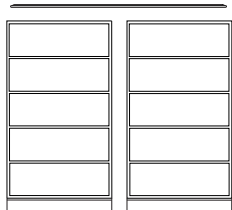

One 98TPI-7416 modular top.  
Two 98BCM-3616-71 modular bookcases.

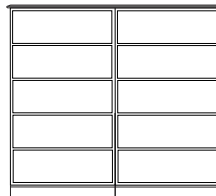

The modular components can be used together to create custom storage.

**DIMENSION KEY**

W — width  
D — depth  
H — height of worksurface  
KW — kneehole width

Dimensions are in inches and approximate.  
Contact Customer Service if dimensions are critical.

\*See page 5 for KrugExpress program.

**CODE DESCRIPTION**

G - includes glass doors  
BC - bookcase  
BCM- modular bookcase  
TPI- modular bookcase top

**STANDARD FINISHES**

For a complete list of standard wood finishes please see page 841.

**WIRING GROMMET**

One rectangular grommet in a standard position is optional at no charge. Additional rectangular grommets are available at an upcharge of \$125 list.

# STRATFORD | MODULAR COMPONENTS

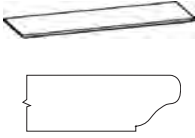
Description	Model	Cherry			W	D	H	Shipping Weight	Cubic Feet
		Walnut							
	98TPI6220	960			61.75	19.75	1.25	45	2
	98TPI6224	1015			61.75	23.75	1.25	52	2
	98TPI6820	1063			67.75	19.75	1.25	53	3
	98TPI6824	1112			67.75	23.75	1.25	61	3
	98TPI7420*	1163			73.75	19.75	1.25	63	3
	98TPI7424	1205			73.75	23.75	1.25	65	3
	98TPI9220	1418			91.75	19.75	1.25	71	3
	98TPI9224	1458			91.75	23.75	1.25	73	3

**ORDERING NOTES:**

Profile of 98TPI tops are inverted.

**Ordering modular storage with 98TPI tops**

71 high modular storage units are created by combining 98TPI modular tops and modular bases.

The top profile on a 98TPI matches that of all other 71 high Stratford products including hutches and freestanding storage. For example:



One 98TPI-7424 modular top.  
One 98STM-362471-04G modular storage. One 98STM-362471-04 modular storage.

The modular components can be used together to create a variety of custom storage.

**Modular Top and Storage Flush Combinations**

Use this guide of recommendations to create flush units with modular tops and storage.

TOP SIZE	PEDESTAL COMBINATIONS THAT FIT FLUSH	LEFT/RIGHT OVERHANG
<b>5-hi modular storage</b>		
98TPI-62	(2) 30 wide pedestals	1
98TPI-68	(2) 30 wide pedestals and (1) 36 wide pedestal	1
98TPI-74	(2) 36 wide pedestals	1
98TPI-92	(3) 30 wide pedestals	1

**Pot light option for modular storage**

**Upcharge**

**525**

The factory installed pot light option is available on any glass door or grill door modular storage unit at an upcharge of \$525. The light is mounted through the top of the storage unit and the modular top and activated by a switch located on the light inside the case. Please add the upcharge shown to storage price and specify pot light option on your order.

A drawing showing assembled configuration of all modular storage must be provided when ordering the pot light option to accurately determine grommet locations.

**ORDERING PROCEDURES**

To order, please specify the following:

- 1) Krug product model number
- 2) Wood species and finish, see page 841
- 4) Pull style and finish, see page 845
- 5) Grommet location and style if applicable

\* Indicates model illustrated by line drawing

**CODE DESCRIPTION**

- TP - modular top with standard profil
- TPR - modular top for run-offs with one coved connecting end
- TPI - modular top with inverted profil
- ST - freestanding storage
- STM - modular storage
- WRM - modular wardrobe
- G - includes glass doors
- D - 2 file drawer
- F - 2 box, 1 file drawe

**STANDARD FINISHES**

For a complete list of standard wood finishes please see page 772.

**STORAGE**

Freestanding storage has finished, profiled tops and base molding on three sides. Modular storage does not have finished tops (they must be ordered separately) and base molding is only across the front.

# STRATFORD | MODULAR COMPONENTS

Description	Model	Cherry		W	D	H	Shipping Weight	Cubic Feet
		Walnut						
2 Lateral Files, 3 Open Shelves	98STM30207103	3689		29.75	19.75	70.5	198	28
	98STM36207103	3780		35.75	19.75	70.5	208	34
	98STM30247103*	3736		29.75	23.75	70.5	208	34
	98STM36247103	3830		35.75	23.75	70.5	218	40

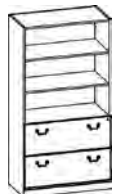

### ORDERING NOTES:

Modular storage units do not have finished tops and are intended to be combined with 98TP tops. Modular storage unit backs are finished

2 Lateral File, 3 Closed Shelves	98STM30207104	4128		29.75	19.75	70.5	206	28
	98STM36207104	4223		35.75	19.75	70.5	216	34
	98STM30247104*	4172		29.75	23.75	70.5	216	34
	98STM36247104	4272		35.75	23.75	70.5	226	40



### ORDERING NOTES:

Modular storage units do not have finished tops and are intended to be combined with 98TP tops. Modular storage unit backs are finished

2 Lateral Files, 3 Closed Clear Glass Doors	98STM30207104G	4355		29.75	19.75	70.5	216	28
	98STM36207104G	4448		35.75	19.75	70.5	226	34
	98STM30247104G*	4398		29.75	23.75	70.5	226	34
	98STM36247104G	4498		35.75	23.75	70.5	236	40

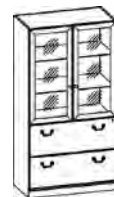

### ORDERING NOTES:

All shelves in glass door bookcases are 1/4" thick glass. Modular pedestals do not have finished tops and are intended to be combined with 98TP tops. Modular pedestal backs are finished. This item is NOT available on KrugExpress.

### DIMENSION KEY

W — width  
D — depth  
H — height of worksurface  
KW— kneehole width

Dimensions are in inches and approximate. Contact Customer Service if dimensions are critical.

\*See page 5 for KrugExpress program.

### CODE DESCRIPTION

TP - modular top with standard profil  
TPR - modular top for run-offs with one coved connecting end  
TPI - modular top with inverted profil  
ST - freestanding storage  
STM - modular storage  
WRM - modular wardrobe  
G - includes glass doors  
D - 2 file drawer  
F - 2 box, 1 file drawe

### STANDARD FINISHES

For a complete list of standard wood finishes please see page 841.

### STORAGE

Freestanding storage has finished, profiled tops and base molding on three sides. Modular storage does not have finished tops (they must be ordered separately) and base molding is only across the front.

# STRATFORD | MODULAR COMPONENTS

Description	Model	Cherry		W	D	H	Shipping Weight	Cubic Feet
		Walnut						
2 Lateral Files, 3 Closed Grill Doors	98STM30207104Z	5110		29.75	19.75	70.5	206	28
	98STM36207104Z	5203		35.75	19.75	70.5	216	34
	98STM30247104Z*	5152		29.75	23.75	70.5	216	34
	98STM36247104Z	5252		35.75	23.75	70.5	226	40

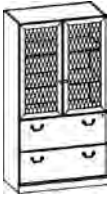

### ORDERING NOTES:

All shelves in glass door bookcases are 1/4" thick glass. Modular pedestals do not have finished tops and are intended to be combined with 98TP tops. Modular pedestal backs are finished. This item is NOT available on KrugExpress.

5 Closed Shelves	98STM30207111	3457		29.75	19.75	70.5	225	28
	98STM30247111	3444		29.75	19.75	70.5	235	34
	98STM36207111*	3493		35.75	23.75	70.5	245	34
	98STM36247111	3539		35.75	23.75	70.5	255	40



### ORDERING NOTES:

Modular storage units do not have finished tops and are intended to be combined with 98TP tops. Modular storage unit backs are finished

5 Closed Shelves Left, Closed Wardrobe Right	98WRM30247101	3204		29.75	19.75	70.5	225	34
	98WRM36247101*	3331		35.75	23.75	70.5	245	40

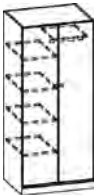

### ORDERING NOTES:

Modular storage units do not have finished tops and are intended to be combined with 98TP tops. Modular storage unit backs are finished

### ORDERING PROCEDURES

To order, please specify the following:

- 1) Krug product model number
- 2) Wood species and finish, see page 841
- 4) Pull style and finish, see page 845
- 5) Grommet location and style if applicable

\* Indicates model illustrated by line drawing

### CODE DESCRIPTION

TP - modular top with standard profil  
 TPR - modular top for run-offs with one coved connecting end  
 TPI - modular top with inverted profil  
 ST - freestanding storage  
 STM - modular storage  
 WRM - modular wardrobe  
 G - includes glass doors  
 D - 2 file drawer  
 F - 2 box, 1 file drawe

### STANDARD FINISHES

For a complete list of standard wood finishes please see page 772.

### STORAGE

Freestanding storage has finished, profiled tops and base molding on three sides. Modular storage does not have finished tops (they must be ordered separately) and base molding is only across the front.



# STRATFORD | BOOKCASES

Description	Model	Cherry Walnut	W	D	H	Shipping Weight	Cubic Feet
2-Hi Open	98BC361630	1604	35.75	16	30.5	91	12



**ORDERING NOTES:**

This 30.25" high bookcase has a 1-1/2" overhang on the left and right sides. There is no overhang on the back edge.

2-Hi with Clear Glass Doors	98BC36163011G	1699	35.75	16	30.5	101	12
-----------------------------	---------------	------	-------	----	------	-----	----



**ORDERING NOTES:**

This 30.25" high bookcase has a 1-1/2" overhang on the left and right sides. There is no overhang on the back edge. The glass shelf is 1/4" thick and adjustable. This item is NOT available on KrugExpress.

Open Bookcase	98BC361657	2036	35.75	16	57	115	22
	98BC361671*	2205	35.75	16	70.5	166	27



**ORDERING NOTES:**

This bookcase has a 1" overhang on the left and right sides. There is no overhang on the back edge.

Computer Stand	98TH3624	2252	35.75	23.75	30.5	61	22
	98TH4824*	2476	47.75	23.75	30.5	82	28

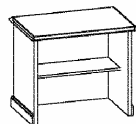

**ORDERING NOTES:**

The computer stand includes a grommet in the back panel.

**DIMENSION KEY**

W — width  
D — depth  
H — height of worksurface  
KW— kneehole width

Dimensions are in inches and approximate. Contact Customer Service if dimensions are critical.

\*See page 5 for KrugExpress program.

**CODE DESCRIPTION**

G - includes glass doors  
BC - bookcase  
BCM- modular bookcase  
TPI- modular bookcase top

**STANDARD FINISHES**

For a complete list of standard wood finishes please see page 841.

**WIRING GROMMET**

One rectangular black or one antique brass grommet in a standard position is optional at no charge. Please note grommet choice clearly on order form. Additional grommets are available at an upcharge of \$125 list.

# STRATFORD | FREESTANDING STORAGE

Description	Model	Cherry Walnut				Shipping Weight	Cubic Feet
			W	D	H		
2 Lateral Files	98ST30203001*	2800	29.75	19.75	30.5	140	13
	98ST36203001	2904	35.75	19.75	30.5	145	15
	98ST30243001	2833	29.75	19.75	30.5	145	15
	98ST36243001	2946	35.75	19.75	30.5	150	18



2 Closed Shelves	98ST30203011*	2139	29.75	19.75	30.5	100	13
	98ST36203011	2208	35.75	19.75	30.5	130	15
	98ST30243011	2174	29.75	19.75	30.5	130	15
	98ST36243011	2250	35.75	19.75	30.5	135	18

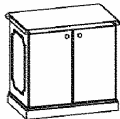

### ORDERING NOTES:

Locks may be added to bookcase or wardrobe doors at a \$116 list upcharge.

4 Lateral Files	98ST30205701*	3985	29.75	19.75	57	186	28
	98ST36205701	4242	35.75	19.75	57	211	34
	98ST30245701	4081	29.75	23.75	57	211	34
	98ST36245701	4335	35.75	23.75	57	236	40



2 Lateral Files, 3 Open Shelves	98ST30207103*	4241	29.75	19.75	70.5	220	28
	98ST36207103	4349	35.75	19.75	70.5	230	34
	98ST30247103	4296	29.75	23.75	70.5	230	34
	98ST36247103	4406	35.75	23.75	70.5	240	40



### ORDERING PROCEDURES

To order, please specify the following:

- 1) Krug product model number
- 2) Wood species and finish, see page 841
- 4) Pull style and finish, see page 845
- 5) Grommet location and style if applicable

\* Indicates model illustrated by line drawing

### CODE DESCRIPTION

TP - modular top with standard profil  
 TPR - modular top for run-offs with one coved connecting end  
 TPI - modular top with inverted profil  
 ST - freestanding storage  
 STM - modular storage  
 WRM - modular wardrobe  
 G - includes glass doors  
 D - 2 file drawer  
 F - 2 box, 1 file drawer

### STANDARD FINISHES

For a complete list of standard wood finishes please see page 772.

### STORAGE

Freestanding storage has finished, profiled tops and base molding on three sides. Modular storage does not have finished tops (they must be ordered separately) and base molding is only across the front.

# STRATFORD | FREESTANDING STORAGE

Description	Model	Cherry	W	D	H	Shipping	Cubic
		Walnut					
2 Lateral File, 3 Closed Shelves	98ST30207104*	4749	29.75	19.75	70.5	240	28
	98ST36207104	4857	35.75	19.75	70.5	250	34
	98ST30247104	4798	29.75	23.75	70.5	250	34
	98ST36247104	4912	35.75	23.75	70.5	260	40

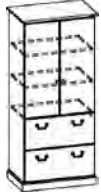

**ORDERING NOTES:**

Locks may be added to bookcase or wardrobe doors at a \$116 list upcharge.

2 Lateral Files, 3 Closed Clear Glass Doors	98ST30207104G*	4974	29.75	19.75	70.5	250	28
	98ST36207104G	5082	35.75	19.75	70.5	260	34
	98ST30247104G	5024	29.75	23.75	70.5	260	34
	98ST36247104G	5140	35.75	23.75	70.5	270	40



**ORDERING NOTES:**

All shelves in glass door bookcases are 1/4" thick glass. This item is NOT available on KrugExpress.

2 Lateral Files, 3 Closed Grill Doors	98ST30207104Z*	5502	29.75	19.75	70.5	240	28
	98ST36207104Z	5611	35.75	19.75	70.5	250	34
	98ST30247104Z	5552	29.75	23.75	70.5	250	34
	98ST36247104Z	5666	35.75	23.75	70.5	260	40

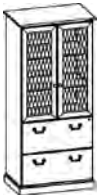

**ORDERING NOTES:**

All shelves in glass door bookcases are 1/4" thick glass. This item is NOT available on KrugExpress.

**DIMENSION KEY**

W — width  
D — depth  
H — height of worksurface  
KW — kneehole width

Dimensions are in inches and approximate.  
Contact Customer Service if dimensions are critical.

\*See page 5 for KrugExpress program.

**CODE DESCRIPTION**

TP - modular top with standard profil  
TPR - modular top for run-offs with one coved connecting end  
TPI - modular top with inverted profil  
ST - freestanding storage  
STM - modular storage  
WRM - modular wardrobe  
G - includes glass doors  
D - 2 file drawer  
F - 2 box, 1 file drawe

**STANDARD FINISHES**

For a complete list of standard wood finishes please see page 841.

**STORAGE**

Freestanding storage has finished, profiled tops and base molding on three sides. Modular storage does not have finished tops (they must be ordered separately) and base molding is only across the front.

# STRATFORD | FREESTANDING STORAGE

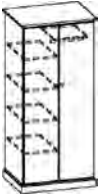
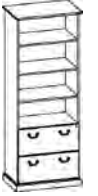
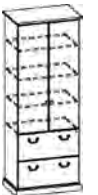
Description	Model	Cherry Walnut	W	D	H	Shipping Weight	Cubic Feet
 5 Closed Shelves	98ST30207111	3911	29.75	19.75	70.5	230	28
	98ST36207111	4019	35.75	19.75	70.5	240	34
	98ST30247111*	3961	29.75	23.75	70.5	240	34
	98ST36247111	4070	35.75	23.75	70.5	250	40
 5 Closed Shelves Left, Closed Wardrobe Right	98WR30247101*	3682	29.75	23.75	70.5	245	34
	98WR36247101	3830	35.75	23.75	70.5	265	40
 2 Lateral Files, 4 Open Shelves	98ST30208403	4857	29.75	19.75	83.5	260	33
	98ST36208403	4905	35.75	19.75	83.5	270	40
	98ST30248403*	4926	29.75	23.75	83.5	270	40
	98ST36248403	4979	35.75	23.75	83.5	290	47
 2 Lateral File, 4 Closed Shelves	98ST30208404	5039	29.75	19.75	83.5	285	33
	98ST36208404	5085	35.75	19.75	83.5	295	40
	98ST30248404*	5110	29.75	23.75	83.5	295	40
	98ST36248404	5166	35.75	23.75	83.5	315	47

### ORDERING NOTES:

Locks may be added to bookcase or wardrobe doors at a \$116 list upcharge.

### ORDERING PROCEDURES

To order, please specify the following:

- 1) Krug product model number
- 2) Wood species and finish, see page 841
- 4) Pull style and finish, see page 845
- 5) Grommet location and style if applicable

\* Indicates model illustrated by line drawing

### CODE DESCRIPTION

TP - modular top with standard profil  
 TPR - modular top for run-offs with one coved connecting end  
 TPI - modular top with inverted profil  
 ST - freestanding storage  
 STM - modular storage  
 WRM - modular wardrobe  
 G - includes glass doors  
 D - 2 file drawer  
 F - 2 box, 1 file drawe

### STANDARD FINISHES

For a complete list of standard wood finishes please see page 772.

### STORAGE

Freestanding storage has finished, profiled tops and base molding on three sides. Modular storage does not have finished tops (they must be ordered separately) and base molding is only across the front.

# STRATFORD | FREESTANDING STORAGE

Description	Model	Cherry Walnut	W	D	H	Shipping Weight	Cubic Feet
2 Lateral Files, 4 Closed Clear Glass Doors	98ST30208404G	5266	29.75	19.75	83.5	295	33
	98ST36208404G	5313	35.75	19.75	83.5	205	40
	98ST30248404G*	5332	29.75	23.75	83.5	205	40
	98ST36248404G	5391	35.75	23.75	83.5	325	47



**ORDERING NOTES:**

All shelves in glass door bookcases are 1/4" thick glass. This item is NOT available on KrugExpress.

2 Lateral Files, 4 Closed Grill Doors	98ST30208404Z	5793	29.75	19.75	83.5	285	33
	98ST36208404Z	5838	35.75	19.75	83.5	295	40
	98ST30248404Z*	5862	29.75	23.75	83.5	295	40
	98ST36248404Z	5917	35.75	23.75	83.5	315	47

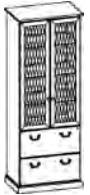

**ORDERING NOTES:**

All shelves in glass door bookcases are 1/4" thick glass. This item is NOT available on KrugExpress.

6 Closed Shelves	98ST30208411	4301	29.75	19.75	83.5	250	33
	98ST36208411	4421	35.75	19.75	83.5	260	40
	98ST30248411*	4359	29.75	23.75	83.5	260	40
	98ST36248411	4476	35.75	23.75	83.5	270	47



**ORDERING NOTES:**

Locks may be added to bookcase or wardrobe doors at a \$116 list upcharge.

Mobile Pedestals	98MP1620294D*	1724	15.75	20	29	78	6
	98MP1620294F**	1832	15.75	20	29	80	6



**DIMENSION KEY**

W — width  
D — depth  
H — height of worksurface  
KW — kneehole width

Dimensions are in inches and approximate. Contact Customer Service if dimensions are critical.

\*See page 5 for KrugExpress program.

**CODE DESCRIPTION**

TP - modular top with standard profil  
TPR - modular top for run-offs with one coved connecting end  
TPI - modular top with inverted profil  
ST - freestanding storage  
STM - modular storage  
WRM - modular wardrobe  
G - includes glass doors  
D - 2 file drawer  
F - 2 box, 1 file drawe

**STANDARD FINISHES**

For a complete list of standard wood finishes please see page 841.

**STORAGE**

Freestanding storage has finished, profiled tops and base molding on three sides. Modular storage does not have finished tops (they must be ordered separately) and base molding is only across the front.

# STRATFORD | RECEPTION

Description	Model	Cherry		W	D	H	Shipping Weight	Cubic Feet
		Walnut						
Gallery Reception Desk	98GD72304LFR0	5613		73.5	30.5	43	325	66
	98GD72304LORF	5613		73.5	30.5	43	325	66

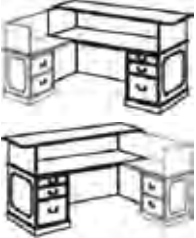

**ORDERING NOTES:**

Laminate worksurfaces are available at a 10% upcharge. 30" deep Stratford desks have a 1-1/2" overhang on the guest side. 36" deep Stratford desks have a 7 1/2" overhang on the guest side. See page 795 for more information on the desks overhang and chassis dimensions. A burled walnut top option is available at a 20% upcharge.

Reception Return	98GRH4824L4D	2898		47.75	23.75	41.75	28.5	250	38
	98GRH4824R4D	2898		47.75	23.75	41.75	28.5	250	38

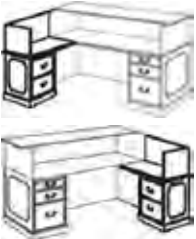

**ORDERING NOTES:**

Laminate worksurfaces are available at a 10% upcharge. 30" deep Stratford desks have a 1-1/2" overhang on the guest side. 36" deep Stratford desks have a 7 1/2" overhang on the guest side. See page 795 for more information on the desks overhang and chassis dimensions. A burled walnut top option is available at a 20% upcharge.

Gallery Reception Linking Units	98GLU4224H	1563		41.75	23.75	41.75		105	34
---------------------------------	------------	------	--	-------	-------	-------	--	-----	----

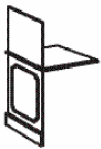

**ORDERING NOTES:**

Linking unit is used to connect Gallery Desk and Credenza to form a 'U' station.

Reception Credenzas	98GC7224L4D	4786		71.75	23.75	41.75		320	57
	98GC7224L4F	4786		71.75	23.75	41.75		320	57
	98GC7224R4D	4786		71.75	23.75	41.75		320	57
	98GC7224R4F	4786		71.75	23.75	41.75		320	57
	98GC7824L4D	5297		77.75	23.75	41.75		355	60
	98GC7824L4F*	5297		77.75	23.75	41.75		355	60
	98GC7824R4D	5297		77.75	23.75	41.75		355	60
	98GC7824R4F	5297		77.75	23.75	41.75		355	60

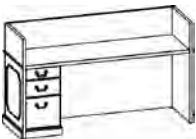

Transaction Top	98GRT66	1106		66.75	12	1.25		48	2
-----------------	---------	------	--	-------	----	------	--	----	---



**ORDERING NOTES:**

Laminate worksurfaces are available at a 10% upcharge. 30" deep Stratford desks have a 1-1/2" overhang on the guest side. 36" deep Stratford desks have a 7 1/2" overhang on the guest side. See page 849 for more information on the desks overhang and chassis dimensions. A burled walnut top option is available at a 20% upcharge.

**ORDERING PROCEDURES**

To order, please specify the following:

- 1) Krug product model number
- 2) Wood species and finish, see page 841
- 4) Pull style and finish, see page 845
- 5) Grommet location and style if applicable

\* Indicates model illustrated by line drawing

**CODE DESCRIPTION**

- 0 - no pedestal
- 4 - full height pedestals
- D - 2 file drawer
- F - 2 box, 1 file drawer
- L - left hand support position
- R - right hand support position
- CD - center drawer
- OT - oversized top option
- BT - bow top option
- CC - corner credenza

**STANDARD FINISHES**

For a complete list of standard wood finishes please see page 772.

**WIRING GROMMET**

One rectangular black or one antique brass grommet in a standard position is optional at no charge. Please note grommet choice clearly on order form. Additional grommets are available at an upcharge of \$125 list..



FSC  
www.fsc.org  
FSC® C021699

The mark of responsible forestry



All products are air emissions certified and are available as FSC® certified

# krug

solutions@krug.ca | www.krug.ca | 1.888.578.KRUG

May 2019